

Best Management Practices (BMPs) for Controlling Erosion, Sediment, and Pollutant Runoff from Construction Sites

**Planning and Technical Specifications Manual
for Stormwater Pollution Prevention Plans**



Kentucky Erosion Prevention and Sediment Control

Best Management Practices (BMPs) for Controlling Erosion, Sediment, and Pollutant Runoff from Construction Sites

Revised October 2009

This publication was first developed in 2004 with guidance and assistance from the Technical Review Committee listed on page 249 which also gives background information. The publication has been revised to reflect recent changes in US EPA and Kentucky stormwater regulations.

Funding to revise and publish the manual has been provided by the Compliance Assistance Project, a joint effort of the University of Kentucky and the Kentucky Department for Environmental Protection.

This revised publication was produced by the Technology Transfer Program, Kentucky Transportation Center, University of Kentucky with technical expertise provided by Barry Tanning, Tetra Tech, with review by the Kentucky Division of Water.

Publication Statement:

Best Management Practices (BMPs) for Controlling Erosion, Sediment, and Pollutant Runoff from Construction Sites is published by the Technology Transfer Program, Kentucky Transportation Center, University of Kentucky. The opinions, findings, or recommendations expressed in this publication are those of the author and do not necessarily reflect the views of the University of Kentucky. Any product mentioned in the Manual is for informational purposes only and should not be considered as a product endorsement. Comments may be addressed to:

Technology Transfer Program
Kentucky Transportation Center
University of Kentucky
176 Raymond Building
Lexington, KY 40506-0281
800-432-0719
www.kyt2.com

Kentucky Department for Environmental Protection
Division of Water
200 Fair Oaks Lane, Fourth Floor
Frankfort, KY 40601
502-564-3410
www.water.ky.gov

Contents

- 1. Introduction**1
 - 1.1 Purpose of the Manual1
 - 1.2 Water Quality Impacts During Construction2
 - 1.3 Construction Site Pollutants of Concern3
 - 1.4 Water Quality Impacts After Construction5
 - 1.5 General Approach to Stormwater Management5
- 2. Regulatory Considerations**6
 - 2.1 KPDES Stormwater Permitting6
 - 2.2 Local Erosion Prevention and Sediment Control Programs7
 - 2.3 Utility Construction Requirements9
 - 2.4 Kentucky Transportation Cabinet (KYTC) Requirements9
 - 2.5 Clean Water Act Sections 401 and 404 Requirements10
 - 2.6 KY Floodplain Construction Permit12
 - 2.7 Integrating Large Projects with Watershed Management Objectives15
- 3. Developing a Stormwater Pollution Prevention Plan**17
 - 3.1 Erosion Prevention & Sediment Control18
 - 3.2 Housekeeping and Other Control Measures21
 - 3.3 Post-Construction Stormwater Management21
 - 3.4 Principles for Selecting Runoff Controls25
 - 3.5 Stormwater Pollution Prevention Plan Contents26
 - 3.6 Standard Notes for SWPPPs32
 - 3.7 Inspections and Maintenance33
- 4. Technical Specifications for BMPs**36
 - 4.1 BMP Selection Guidelines36
 - 4.2 BMP Map and Plan Symbols41
 - 4.3 Site Preparation**43
 - 4.3.1 Land Grading45
 - 4.3.2 Construction Exit48
 - 4.3.3 Temporary Diversion (Berm or Ditch)51
 - 4.3.4 Topsoil Stockpiling54
 - 4.3.5 Surface Roughening57
 - 4.4 Soil Stabilization**60
 - 4.4.1 Temporary Seeding61
 - 4.4.2 Permanent Seeding63
 - 4.4.3 Mulching66
 - 4.4.4 Sodding70
 - 4.4.5 Polyacrylamides73
 - 4.4.6 Dust Control75
 - 4.5 Slope Protection**77
 - 4.5.1 Silt Fence79
 - 4.5.2 Brush, Rock, and Other Sediment Barriers88

| | |
|--|------------|
| 4.5.3 Erosion Control Blankets and Turf Reinforcement Mats | 90 |
| 4.5.4 Temporary Slope Drains | 100 |
| 4.5.5 Gabion Baskets and Mattresses | 103 |
| 4.5.6 Cellular Confinement Systems | 108 |
| 4.6 Drainage System Controls | 110 |
| 4.6.1 Curb Inlet Sediment Barrier | 112 |
| 4.6.2 Drop Inlet Sediment Barrier | 116 |
| 4.6.3 Culvert Inlet Sediment Barrier | 119 |
| 4.6.4 Culvert Outlet Energy Dissipator | 121 |
| 4.6.5 Rock-Lined Ditches and Channels | 125 |
| 4.6.6 Grass-Lined Ditches and Channels | 129 |
| 4.6.7 Check Dams for Ditches and Channels | 135 |
| 4.7 Sediment Traps and Basins | 138 |
| 4.7.1 Temporary Sediment (Silt) Traps | 139 |
| 4.7.2 Sediment (Detention) Basins | 145 |
| 4.7.3 Dewatering Devices | 152 |
| 4.8 Stream and Wetland Protection | 154 |
| 4.8.1 Buffer Zones | 156 |
| 4.8.2 Filter Strips | 158 |
| 4.8.3 Temporary Stream Crossing | 162 |
| 4.8.4 Bioengineering: Live Staking | 165 |
| 4.8.5 Wattles (Live Fascines) | 170 |
| 4.8.6 Brushlayering | 175 |
| 4.9 Good Housekeeping and Other Stormwater Controls | 179 |
| 4.9.1 Material Delivery, Storage, and Use | 180 |
| 4.9.2 Spill Prevention and Control | 181 |
| 4.9.3 Vehicle and Equipment Maintenance | 183 |
| 4.9.4 Debris and Trash Management | 184 |
| 4.9.5 Hazardous Waste Management | 187 |
| 4.9.6 Concrete Waste Management | 190 |
| 4.9.7 Sanitary Facilities | 192 |
| 4.9.8 Employee Training | 193 |
| 4.9.9 Groundwater Protection | 194 |

Appendices

| | | |
|------------|---|-----|
| Appendix A | Example Stormwater Pollution Prevention Plan for a Construction Project in Kentucky | 197 |
| Appendix B | Example Site Plan Drawings | 211 |
| Appendix C | Site Runoff Calculations | 215 |
| Appendix D | Construction Site Inspection Report | 223 |
| Appendix E | USACE Clean Water Act Section 404 Summary | 227 |
| Appendix F | Definitions | 233 |

1. Introduction

This Planning and Technical Specifications Manual contains information on Best Management Practices (BMPs) for preventing, reducing, and controlling erosion, sediment, and pollutant runoff from construction sites and other cleared, excavated, or filled areas. The manual was developed to help engineers, landscape architects, developers, construction managers, and others plan and implement measures that reduce harmful water quality impacts from construction projects and other land-clearing activities. The manual begins by explaining potential water quality impacts from construction and development, then summarizes applicable federal, state, and local regulations. The next sections explain basic principles for selecting, designing, and implementing construction site BMPs and provide detailed information on the most commonly used BMPs.

The information in this manual can be used to select, install, and maintain BMPs on construction sites and to develop Stormwater Pollution Prevention Plans (SWPPPs) to manage runoff from those sites. SWPPPs are required in Kentucky and other states for all construction projects that expose one acre or more of bare soil. This includes stripping or clearing vegetation, excavation, or placement of fill dirt.

The manual is consistent with other Kentucky state and local guides that contain information on controlling polluted runoff from construction sites (see www.water.ky.gov/permitting/wastewaterpermitting/KPDES/storm/). Some state agency and local government guides contain additional information that might be helpful in complying with contract terms, local ordinances, regulations, or other requirements. For example, the Kentucky Transportation Cabinet (KYTC) *Specifications for Road and Bridge Construction* should be consulted by those working on state highway projects. Sections 212, 213, and 214 address erosion control, water pollution control, and geotextile construction, respectively (see www.kytc.state.ky.us/construction/spec/2004/2004_Division200.pdf). KYTC stormwater management and other water pollution control resources can be found at www.kytc.state.ky.us/EnvAnalysis/Stormwaterquality/Default.htm. Projects in Jefferson County should comply with the Louisville-Jefferson County Metropolitan Sewer District *Standard Drawings, Design Manual, and Specifications*, posted at www.msdlouky.org/insidemsd/standard-drawings.htm. Kentucky cities that are subject to U.S. Environmental Protection Agency (EPA) Stormwater Phase II requirements for urbanized areas operating municipal separate storm sewer systems (MS4s) can use the information in this manual, which is consistent with the *Kentucky Stormwater Consortium BMP Manual* posted at www.bgky.org/publicworks/planningdesign/bmpindex.htm. Timber harvest personnel should consult the *KY Forest Practice Guidelines for Water Quality Management*, the complete handbook of the Best Management Practices required under the Forest Conservation Act. The guidelines are posted at www.ca.uky.edu/agc/PUBS/for/for67/intro.pdf.

Best Management Practices (BMPs) are planning/operational approaches, structural installations, and other field practices for reducing erosion, sediment loss, and polluted runoff from construction sites or other areas.

1.1 Purpose of the Manual

The purpose of this manual is to describe:

- Potential water quality impacts of construction and development activities
- Procedures for planning, designing, installing, and maintaining BMPs that control pollutants from construction activities and development sites
- Federal, state, and local regulations that apply to construction site runoff
- Technical information on specific BMPs



1.2 Water Quality Impacts During Construction

Clearing, grading, excavation, and placement of fill material expose soil to the weather. Sediment particles are then easily picked up by wind or water and washed away through erosion. When stormwater flows over an active construction site, it picks up other pollutants as well. As runoff velocities increase, the ability of water to dislodge and move larger soil particles and rock increases exponentially. High volumes of runoff water leaving a site can also cause stream bank erosion and destroy downstream aquatic habitat. In addition to the environmental impact, uncontrolled erosion can have a significant financial impact on a construction project.

Stormwater Pollution Prevention Plans (SWPPPs) are written descriptions of construction sites, their soil and drainage characteristics, and how site operators will control erosion, sediment, and pollutant runoff through planning/operational approaches (e.g., prompt seeding and mulching) and structural field installations (e.g., silt fencing, ditch liners, sediment traps). SWPPPs and KPDES permits are required for all construction sites with one acre or more of exposed soil.

Sediment runoff from construction sites is a pollutant of concern in Kentucky causing widespread siltation of stream benthic habitat, increasing overall water column turbidity, and adding to sediment bed loads. According to the *2008 Kentucky Report to Congress on Water Quality and Sedimentation*, siltation is the leading cause of impairment to rivers and streams in the state. Suspended solids,

also attributable in part to construction site runoff, are among the leading causes of lake impairments, according to the report. Nutrient loading, which can be caused or worsened by construction site runoff, is the third leading cause of river, stream, and lake impairment.

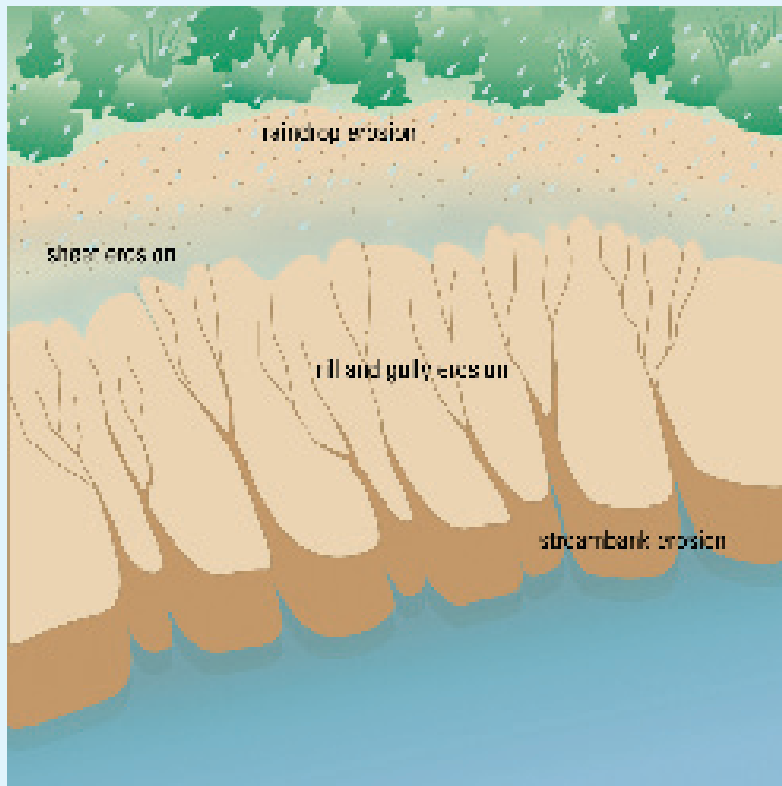

Types of erosion. Raindrop erosion breaks down soil structure. Slope runoff creates sheet erosion, which can lead to the formation of small rill channels and larger gullies. Erosion of unprotected stream banks can be caused by removing vegetation and higher flows caused by runoff from pavement, sidewalks, and roofs in newly developed areas.

Leading Causes of Pollution in Kentucky Streams and Rivers

| Cause | Miles Affected |
|---|----------------|
| Sedimentation/Siltation | 3,003.67 |
| Fecal coliform + <i>E. coli</i> (pathogen indicators) | 2,955.75 |
| Nutrient/eutrophication biological indicators | 1,525.20 |
| Habitat Assessment (streams) | 999.07 |
| Cause unknown | 730.35 |
| Organic enrichment (sewage) biological indicators | 721.75 |
| Total dissolved solids | 704.62 |
| Physical substrate habitat alterations | 478.40 |

Source: Kentucky Division of Water, 305(b) Report

Leading Causes of Pollution in Kentucky Lakes

| Cause | Acreage Affected |
|---|------------------|
| Methylmercury | 78,313 |
| Mercury in Fish Tissue | 14,142 |
| Nutrient/Eutrophication Biological Indicators | 9,724 |
| pH | 8,489 |
| Oxygen, Dissolved | 8,388 |
| PCB in Fish Tissue | 8,210 |
| Dissolved Gas Supersaturation | 3,864 |
| Total Suspended Solids (TSS) | 3,040 |
| Sedimentation/Siltation | 2,417 |

Source: Kentucky Division of Water, 305(b) Report

The sources of siltation, suspended solids, and nutrient loads are many, and it is not clear what portion of the problem can be directly attributable to sediment and erosion from construction sites. Sources of siltation, suspended solids, and nutrients vary significantly across the Commonwealth because of land use variability and other factors, but it is generally recognized that new development and construction sites contribute to siltation and nutrient enrichment of surface waters.

It costs money and takes time to repair gullies, replace vegetation, clean sediment-clogged storm drains, replace poorly installed BMPs, and mitigate damage to downstream property or to natural resources. **Preventing soil erosion, sedimentation, and runoff of other pollutants like concrete wastes, paint wash water, trash, and so on, is an important responsibility at all construction sites.** Sediment is most frequently associated with stormwater runoff from construction sites. Other pollutants of concern, such as nutrients; metals; pesticides; oil; grease and fuel; toxic chemicals; and general solid waste such as litter originate from common construction activities and can be discharged during rain events.

1.3 Construction Site Pollutants of Concern

A variety of substances and materials found on construction sites can become pollutants of concern if they are washed into nearby water bodies, dumped onto porous soils, or discharged directly to surface waters or groundwater. The following subsections summarize these potential pollutants.

Sediment—According to the *2008 Kentucky Report to Congress on Water Quality*, siltation is the leading cause of impairment to rivers and streams in the state. Suspended solids, also attributable in part to construction site runoff, are a leading cause of lake impairments, according to the same report.

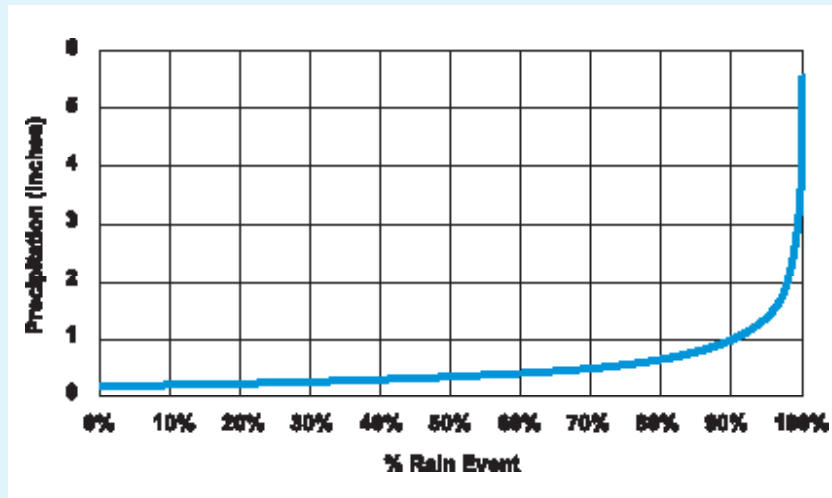

Rainfall frequency distribution for a typical eastern U.S. city. Runoff controls that target small and medium-sized storms—up to 1.5 inches over a 24 hour period—can make a big impact, because most storms fall within this range.

Research over the past three decades has found that erosion rates from construction sites are **an order of magnitude greater** than those measured on row crop lands and several orders of magnitude larger than erosion rates on well-vegetated lands. Soil loss from new development can range from 20–150 tons per acre per year; the national average for soil erosion from crop lands is about 8 tons per acre per year. Sedimentation of streams and rivers from road construction can reduce aquatic insect and fish communities by up to 85 and 40 percent respectively, according to a 1997 study. Other research has found construction-related sediment impacts on small creeks extending as far as 4.8–5.6 kilometers downstream of active construction sites. Siltation is the second leading cause of impaired water quality in rivers and lakes nationally.

Nutrients—Two primary nutrients, phosphorus and nitrogen, are generated by a number of activities on construction sites, such as the application of fertilizer. Sediment, other construction chemicals, and wastes might contain nutrients as well. Discharge of excess nutrients into waterways can result in accelerated growth of vegetation or algae. The decomposition of this vegetation by aerobic bacteria can deplete the oxygen dissolved in the water and cause fish kills. Nutrient loading is the sixth leading cause of river and stream impairment in Kentucky and the third leading cause of lake impairment.

Metals—Metals can become mixed with construction site runoff in a number of ways. They can be washed from surfaces such as treated lumber, paint, or metal materials. Metals also are associated with the operation and maintenance of cars, truck, and other equipment used on construction sites. Concrete mixer truck wash water contains elevated concentrations of hexavalent chromium. Metal molecules commonly attach to sediment particles and are washed away through erosion, which occurs during construction. Heavy metals are toxic to aquatic organisms, can accumulate in fish tissue, and have the potential to contaminate drinking water supplies.

Pesticides—Herbicides, insecticides, and rodenticides are commonly used on construction sites. If pesticides are applied improperly or in excess, they can contaminate waterways, kill aquatic organisms and vegetation, and contaminate drinking water. Pesticides can enter waterways through direct contact (improper application or spills), by drifting in the air and settling in water, or through the erosion of soil particles that have come in contact with the chemical.

Oil, grease, and fuels—Various types of equipment that require maintenance and fuel are used on construction projects. Leaks, spills, and dumping are primary sources of these contaminants on construction sites. Asphalt can be a source of oil in runoff as well. Just one quart of oil can produce a 2-acre oil slick on a pond, lake, or river. One gallon of oil can make one million gallons of water too contaminated to drink, and 35 parts per million of oil will kill fish. Other hydrocarbons generally associated with petroleum products (e.g., gasoline, kerosene, asphalt) can be toxic and might be carcinogenic.

Toxics—The construction of buildings and roads requires the use, storage, and disposal of toxic or hazardous materials such as sealants, concrete, cleaners, adhesives, and solvents. Improper storage and handling of these materials can cause spills and leaks, which can be washed into neighboring waterways during heavy rains. Many of these items contain metals or other toxics that might be harmful to fish and humans.

Solid Waste—A large amount of solid waste is generated at construction sites including concrete waste, mulch, wood material, paper waste, and miscellaneous litter caused by workers. This waste can contribute various pollutants of concern when in contact with runoff water, or the debris can be washed into waterways becoming pollution itself. Solid waste from construction projects can clog waterways or become floating pollution, resulting in aesthetic impacts, public complaints, fines, and other regulatory action.

1.4 Water Quality Impacts after Construction

Unfortunately, the potential for water quality impacts from polluted or accelerated precipitation runoff does not end when construction ends. Increased impervious area (i.e. driveways, parking lots, rooftops) can dramatically alter how runoff flows and how fast it flows over the land. When water can no longer filter into the ground, it must go overland into the nearest storm drain, ditch, or stream. As it flows, the water picks up pollutants and heat from parking lots, lawns, rooftops, or other surfaces. Many of the same pollutants present during construction can also be potential pollutants of concern after construction. Nutrients and pesticides can be used on lawns or landscaping, and metals, oil, grease, and other toxic materials can drip and settle onto parking lots and driveways. Litter or other debris might also be present, depending upon the type of development. All these materials can be picked up by storm runoff and washed into nearby waterways, becoming nonpoint source pollution after construction is complete.

Increased imperviousness also can cause a greater volume of water to leave a site at higher velocities than before development. This runoff can cause damaging erosion on the site and farther downstream, carrying high loads of sediment to receiving water bodies. The water also can scour streambanks, causing damage to property and aquatic habitat. Increased volume and speed of runoff water also can increase the likelihood of flooding on adjacent and downstream properties.

1.5 General Approach to Stormwater Management

Stormwater Pollution Prevention Plans (SWPPPs) can provide guidance for field activities, but even the best plans cannot compensate for field personnel who don't know the basics of controlling stormwater. SWPPPs and field activities to control erosion, sedimentation, and other runoff pollutants should focus on the following common sense principles:

- **Fit the project to the site** by retaining the existing drainage system (if it is stable), minimizing clearing and grading, and maximizing infiltration of precipitation.
- **Minimize the amount of bare soil exposed** and the duration of exposure by phasing the project, limiting clearing and grading to what can be handled during a three week period, and seeding or mulching promptly.
- **Before clearing and grading begins**, install silt fences, sediment traps/basins, upland clear water diversions, and other BMPs. Get to final grade quickly, then seed or mulch.
- **Maintain BMPs** until the grass is up and the ditches are stable. Deal with ruts and washouts promptly. Keep potential pollutants out of the weather and clean up spills promptly.

2. Regulatory Considerations

This manual focuses on BMPs for all construction sites, no matter how large or small. However, it should be noted that construction sites with a disturbed area (i.e., bare soil exposure) of one acre or more are subject to state and federal stormwater regulations. Local regulations may also affect projects that are much smaller than an acre. The following sections summarize some of these statutory and regulatory provisions.

2.1 KPDES Stormwater Permitting

Public agencies at the federal, state, and local levels have implemented rules to deal with impacts from the polluted construction site runoff issues summarized in the preceding section. These rules depend heavily on proper construction planning, knowledgeable field personnel, and common sense implementation of polluted runoff controls (i.e., BMPs).

EPA regulations at Title 40 of the *Code of Federal Regulations* (CFR) 122.26(b)(14)(x) and 122.26(b)(15) require National Pollution Discharge Elimination System (NPDES) permit coverage for stormwater discharges from construction activities that disturb one or more acres. These regulations are implemented

by general NPDES permits issued by EPA and authorized, in Kentucky, by the Kentucky Division

KPDES permits are required for all construction sites that disturb one or more acres. The KPDES Construction General Permit (KYR10) does not cover sites that drain into sediment-impaired waters with approved Total Maximum Daily Loads, waters designated as cold-water aquatic habitat, exceptional waters, outstanding state resource waters, sites with individual KPDES permits, or sites requiring additional stormwater controls due to antidegradation considerations. Individual KPDES permits are required for sites that do not qualify for General Permit coverage. An online KPDES Permit application is available at www.water.ky.gov/permitting/wastewaterpermitting/KPDES/residences.

of Water. The Kentucky Pollution Discharge Elimination System (KPDES) Construction General Permit meets all federal permit requirements.

The KPDES Permit covers all stormwater discharges associated with construction activity that disturbs one acre or more. This “one acre rule” includes all lots—even those smaller than an acre—in subdivisions or developments that will have more one

acre or more of total disturbance, and long narrow projects such as buried pipelines/conduits/sewer lines if the construction width multiplied by the length would equal or exceed one acre. The area of disturbance is defined as only that portion of the site where ground cover or topsoil is removed. The definition of construction site applies equally to rural, suburban or urban areas but does not include tilled agricultural fields. The main goal of the KPDES permit program is to keep sediment and other pollutants out of lakes, rivers, streams, and wetlands. KDOW can require an individual permit if it would better address the discharges from the site.

Basically, the KPDES construction general permit requires operators of construction projects in Kentucky disturbing one acre or more to

- Develop a SWPPP and submit an online or paper-form Notice of Intent (NOI) to Kentucky Division of Water and receive KDOW approval to proceed before land disturbing activity begins.



Stormwater pollution prevention (BMP) plans and KPDES permit coverage are required for all construction sites once acre or larger under 2003 regulations. Plans must be kept on-site and available for inspections.

- Submit a copy of the NOI to the operator of any MS4 into which the site discharges before land disturbing activity begins.
- Implement and continuously update the written Stormwater Pollution Prevention Plan.
- Inspect and document the condition of runoff controls every 7 days, or every 14 days and within 24 hours after each rain of 0.5 inch or more.
- Submit a signed Notice of Termination (NOT) form to Kentucky Division of Water after the site has been finally stabilized.

The SWPPP must be developed in accordance with good practices, and must identify expected sources of pollution and describe how they will be controlled. The SWPPP is completed before construction begins, signed, and kept on-site (note: this can be in a vehicle if there is no office or other suitable location at the site). SWPPPs required by KPDES permits are considered reports that must be made available to the public, upon written request, in accordance with section 308(b) of the Clean Water Act. Deficient plans might require modification upon notification by the Kentucky Division of Water or local regulatory authority. Additional information on construction site SWPPPs can be found in section 3.

The construction site operator must apply for the KPDES permit on sites with a disturbed area of one acre or more. In general, the “operator” is the person who has operational control over plans and specifications, or day-to-day control over site activities. The operator is usually the general contractor, developer, or site owner.

2.2. Local Erosion Prevention and Sediment Control Programs

Cities in Kentucky that have a population of 10,000 or more and those that have polluted runoff problems associated with construction and other urban pollutants are subject to additional stormwater permitting requirements overseen by state water agencies and EPA. This stormwater permit program requires these cities to have ordinances and programs to **control construction site runoff and post-construction runoff impacts**, such as increased stormwater velocity, elevated temperatures, oil and grease contamination, trash, and so on.

Construction site operators (e.g., general contractors, developers, site owners) are responsible for understanding and complying with local ordinances as well as the state KPDES permit program. Most local and state requirements are very similar, but there are some significant differences in Jefferson, Fayette, and northern Kentucky counties. Check with each local government before construction to determine what local regulations and requirements might apply. Below is a summary of local regulations and requirements in addition to those required by the state KPDES permit.

Louisville-Jefferson County Metropolitan Sewer District (MSD)

The Jefferson County Erosion Prevention and Sediment Control Ordinance applies to all land disturbing activities in Jefferson County that are in excess of 5,000 square feet or that require a building permit. All erosion protection and sediment control (EPSC) measures must be designed and installed to accomplish an 80 percent design removal efficiency goal for total suspended solids, using a 10-year, 24-hour storm event design. The MSD Design Manual, Standard Drawings, and Standard Specifications (Chapter 12) contains approved structural and non-structural BMPs for use in achieving this standard.

Structural BMPs include sediment trapping devices, inlet protection measures, perimeter controls and construction entrances. Non-structural methods include phasing a project into manageable pieces, scheduling activities within each phase to minimize amount of disturbed area and provisions for temporary and final stabilization.

The permittee or designee is required to conduct inspections of all EPSC measures and perform any modifications, maintenance or repairs as necessary, every 7 calendar days and within 24 hours of each storm event that produces 0.5 inch or more of precipitation. Records of these inspections must be kept on-site at all times for review by the appropriate compliance enforcement agency. Records must be kept on the Self-Inspection Form with approved construction drawings. MSD has a network of rain gauges that can be queried to determine the amount of rain recorded for a section of the county. MSD will conduct compliance inspections of land disturbing activities and may refer potential violations to MSD for follow-up and enforcement action. For more information and to access the *MSD Design Manual*: www.msdlouky.org/insidemsd/epsc.htm.

Lexington-Fayette Urban County Government (LFUCG)

An erosion and sediment control plan is required for all construction with land disturbing activity of one acre or greater (per the KPDES general permit). The plan must be approved before obtaining a grading permit from LFUCG. In addition, land disturbance on a single residential lot, regardless of size, must comply with erosion and sediment control requirements. Home builders who fail to install the erosion and sediment controls will be issued a notice of violation. The plan must be developed and signed by a professional engineer or landscape architect licensed in Kentucky. All hydrologic, hydraulic, structural, and geotechnical design work included in the plan must be done and signed by a professional engineer licensed in Kentucky. Plans must integrate nonstructural and structural practices and procedures to control erosion and sediment loss. Once the erosion and sediment control practices have been constructed, a grading permit can be obtained. The erosion control permit remains in effect throughout the construction project, including the homebuilding phase of construction for residential subdivisions. Land disturbances for the construction of a structure on a single residential lot are permitted through the building permit process and must comply with LFUCG requirements.

A home builder in the Lexington-Fayette urban area is required to install the erosion and sediment controls listed below to minimize the sediment washing into streets, inlets, stormwater pipes, open channels, and adjacent lots:

| | |
|-----------------------|--|
| Silt fence | Surface inlet protection |
| Construction entrance | Inspection of sediment controls |
| Seed, sod, and mulch | Street cleaning |
| Disposal of trash | Drainage system alterations prohibited |
| Curb inlet protection | Snow fence |

An operation and maintenance plan must be developed that provides a schedule for inspection, maintenance and repair of BMPs during construction activities. A maintenance schedule must also be provided to ensure that permanent measures such as vegetation are properly established after construction is complete. All erosion and sediment controls that are identified in the erosion and sediment control plan (ESCP) must be inspected and maintained. Any erosion and sediment control devices that are damaged must be repaired or replaced immediately. For more information, see the LFUCG Stormwater Manual at www.lexingtonky.gov/index.aspx?page=780.

Sanitation District # 1 (SD1)

Sanitation District # 1 serves 33 communities in Boone, Campbell, and Kenton Counties of northern Kentucky. SD1 has established a permitting system to control stormwater runoff from construction sites and post-construction stormwater management for new developments and redevelopments. The permits are required for construction activity of one acre or larger in Boone, Campbell, and Kenton Counties and the municipalities in those counties covered by the KPDES Small MS4 Stormwater Permit (with the exception of the city of Florence). The land disturbing activity, development activity, or redevelopment activity cannot commence until the District has issued a clearing, grading, or land disturbance permit.

The land disturbance permit is required for (1) any alteration of the earth's surface where natural or man-made ground cover is altered and for which the applicant has not received a clearing or grading

permit and/or (2) the installation of any storm sewer systems (including storm sewer structures and pipes, detention ponds, and so on). The land disturbance permit must also include activities covered by a clearing or grading permit if the applicant did not obtain a separate clearing or grading permit.

The grading permit is required for grading activities on a property. Grading activities include excavation, filling, stockpiling, or other earth moving activities, and any combination thereof. The grading permit may include the construction of sanitary sewers and other utility infrastructure (e.g., water, gas, electric). The installation of storm sewer systems (including storm sewer structures and pipes, detention ponds, and so on) require a land disturbance permit and will not be approved as part of a grading permit. A grading permit is not required if the property owner/applicant receives a land disturbance permit for the property covering the same activity.

The clearing permit is required for clearing activities on a property. Clearing activities include stripping and cutting of trees and ground cover and the removal of roots and associated material. The clearing permit does not include any earth moving activities, including rough shaping of the site. A clearing permit is not required if the property owner/applicant receives a grading or land disturbance permit for the property covering the same activity. Application forms and checklists can be found in the *Northern Kentucky Regional Stormwater Management Program Rules and Regulations* posted at www.sd1.org.

2.3 Utility Construction Requirements

In general, utility construction crews and other subcontractors are responsible for their own erosion and sediment controls. General contractors should make sure that all utilities and subcontractors use rock pad construction entrances or other measures to prevent movement of soil onto public roadways. **Tracking mud out onto paved roads can lead to legal liabilities.** If crews disturb areas that have already been stabilized, they should replace any mulch, sod, seed, blanket, matting, rock, silt fencing, or other material disturbed. Failure to properly grade, seed, and stabilize work sites can violate permit requirements. If your project is larger than one acre and covered under a KPDES Stormwater Permit, it is recommended that subcontractors and others conducting excavation or fill activities sign an agreement stating that they will comply with the SWPPP. If utility projects cross or are conducted in or near streams, Clean Water Act section 404 permit coverage may be required (See Section 2.5).

2.4 Kentucky Transportation Cabinet (KYTC) Requirements

The KYTC inspection performance standard for erosion and sediment control is that no sediment should leave the site. **All KYTC projects are subject to KPDES Stormwater Permit requirements.** KYTC requires that slopes 4:1 or steeper with upland runoff areas exceeding 100 feet and all channels be lined with erosion control blankets. KYTC requires disturbed drainage areas (DDAs) to be identified in construction plans and managed to ensure that no adverse runoff impacts occur. If transportation projects are conducted in or near streams, Clean Water Act section 404 permit coverage may be required (see Section 2.5). KYTC standards also limit the total amount of disturbed area to 750,000 square feet (about 17.2 acres). Written approval from the district engineer is required for exceeding this limit. Bridge construction or repair and other work near streams require substantial erosion and sediment control efforts. KYTC projects are required to establish final grade quickly on as much of the site as possible, then stabilize with seed, mulch, blankets, or matting. Bare soil areas at temporary grade must be seeded and mulched after 14 days if they will not be worked during the following week (i.e., stabilization required after 21 consecutive days).

The KYTC Division of Design prepares the initial SWPPP for highway construction projects as part of the construction specifications. The final plan is completed with input from the resident engineer and contractor. KYTC also files the NOI for KPDES permit coverage. Contractors and subcontractors are required to review, amend, and sign the SWPPP and overall erosion and sediment control measures. Erosion control and water pollution control BMPs to be used on KYTC projects are outlined in the *KYTC Specifications Manual* in sections 212 and 213. The manual can be accessed at: <http://transportation.ky.gov/construction>.

2.5 Clean Water Act Sections 401 and 404 Requirements

Federal and state agencies both have additional requirements for projects that impact regulated water bodies, which can range from a large river or lake to a small channel that flows only for a few days after a rain. Any clearing, grading, excavation, or placement of fill material on or near the banks or channel will likely involve added measures to reduce water quality impacts, as summarized below.

Section 404 permits for work in regulated waters

Section 404 of the Clean Water Act regulates the discharges of dredged or fill materials into the waters of the United States, including small streams and wetlands adjacent or connected to regulated waters. These discharges include return water from dredged material disposed of on the upland and generally any fill material (e.g., rock, sand, dirt) used to construct land for site development, roadways, erosion protection, and so on. Basically, if equipment will be operating in or through a creek, wetland, or river, permit coverage is required.

The U.S. Army Corps of Engineers (USACE) administers the permit program dealing with these activities, in cooperation with EPA and in consultation with the U.S. Forest Service and the National Marine Fisheries Service. Individual permits are issued for activities with significant impacts, and nationwide or regional general permits are issued for activities with impacts not deemed to be significant.

For minor activities covered under section 404 nationwide permits (e.g., road culvert installation, utility line activities, bank stabilization), permit requirements are typically deemed to be met if activities result in only short-term, limited effects and if all appropriate and reasonable measures related to erosion and sediment control, project seeding and stabilization, and prevention of water quality degradation (e.g., working during low-flow conditions) are applied and maintained. A general condition of the 2002 nationwide permit is that, "appropriate soil erosion and sediment controls must be used and maintained in effective operating condition during construction, and all exposed soil and other fills, as well as any work below the ordinary high-water mark or high line, must be permanently stabilized at the earliest practicable date."

Contact information for USACE District Offices serving Kentucky:

Huntington District

502 8th Street, Huntington, WV 25701-2070

Tel: 304-399-5353

Web site: www.lrh.usace.army.mil

Louisville District

PO Box 59, Louisville, KY 40401-0059

Tel: 502-315-6692

Web site: www.lrl.usace.army.mil

Memphis District

Clifford Davis Federal Bldg, Room B-202,

Memphis, TN 38103-1894

Tel: 901-544-3471

Web site: www.mvm.usace.army.mil

Nashville District

3701 Bell Road, Nashville, TN 37214

Tel: 615-369-7500

Web site: www.lrn.usace.army.mil

Overview of Common Nationwide Permits in Kentucky

| Nationwide Permit | Activity Covered by the Permit |
|--|---|
| NWP 3 – Maintenance | Removal of sediment and debris within 200 feet of a structure |
| NWP 7 – Outfall structures and maintenance | Construction of outfalls and dredging of accumulated sediments |
| NWP 12 – Utility Line Activities | Activity that fills less than ½ acre of stream or wetland |
| NWP 13 – Bank Stabilization | Bank stabilization less than 500 feet and less than 1 cubic yard of fill per running foot |
| NWP 14 – Linear Transportation Facilities | Activity that fills less than ½ acre of stream or wetland |
| NWP 18 – Minor Discharges | Activity with less than 25 cubic yards of fill (1/10 acre in special aquatic sites) |
| NWP 19 – Minor Dredging | Activity that dredges less than 25 cubic yards |
| NWP 21 – Surface Coal Mining | Activities related to mining that have been approved by state and federal agencies |
| NWP 27 – Aquatic Habitat Restoration | Restoring, establishing, enhancing aquatic habitat |
| NWP 29 – Residential Development | Activity that fills less than ½ acre of stream or wetland and less than 300 linear feet of stream |
| NWP 35 – Maintenance Dredging of Existing Basins | Dredging to previously authorized depths |
| NWP 40 – Agricultural Activities | Activity that fills less than ½ acre of stream or wetland and less than 300 linear feet of stream |
| NWP 41 – Reshaping Existing Drainage Ditches | Activities that impact less than 500 feet of stream |
| NWP 42 – Recreational Facilities | Activity that fills less than ½ acre of stream or wetland and less than 300 linear feet of stream |
| NWP 43 – Stormwater Management Facilities | Activity that fills less than ½ acre of stream or wetland and less than 300 linear feet of stream |
| NWP 44 – Mining Activities | Activity that fills less than ½ acre of stream or wetland |

If the construction is not covered by a nationwide permit, an individual permit must be obtained from the USACE before beginning work. Processing such permits involves evaluation of individual, project specific applications in what can be considered three steps: pre-application consultation (for major projects), formal project review, and decision making. For more information, see Appendix E and www.usace.army.mil/Pages/default.aspx.

Section 401 Water Quality Certification

Activities that result in physical disturbances to wetlands or streams are regulated by the USACE under Clean Water Act section 404 and require a Clean Water Act section 401 Water Quality Certification (WQC) issued by the Kentucky Division of Water. WQC helps ensure that activities that could involve a discharge into waters of the state are consistent with Kentucky's water quality standards in Title 401, Chapter 5 of the Kentucky Administrative Regulations. Examples of activities that may require a USACE section 404 permit and KY Division of Water section 401 water quality certification include:



Listing the construction site operator and posting applicable permits makes it easy for inspectors to quickly check whether or not a site is in compliance with various state and federal regulations.

- stream relocations
- road crossings
- stream bank protection
- construction of boat ramps
- placing fill
- grading
- dredging
- ditching
- mechanically clearing a wetland
- building in a wetland
- constructing a dam or dike
- stream diversions

For wetland-related impacts involving greater than one acre of wetland loss, the applicant should follow the Wetland Mitigation Requirements when applying for a WQC. Wetland losses involving less than one acre may be regulated by the USACE. The USACE is responsible for making official, jurisdictional wetland determinations.

For stream-related impacts that involve more than 200 linear feet of stream disturbance, the applicant should submit detailed plan and profile drawings along with the application (see draft Stream Mitigation Guidelines on Web site below). Impacts in streams or lakes designated as Special Use Waters require an individual WQC and special attention must be paid to the sediment and erosion control plan. For more information, go to www.water.ky.gov/permitting/wqcert/.

2.6 Kentucky Floodplain Construction Permits

The Kentucky Division of Water Floodplain Management Section has the primary responsibility for the approval or denial of proposed construction and other activities in the 100-year floodplain of all streams in the Commonwealth. Typical activities permitted are dams, bridges, culverts, residential and commercial buildings, placement of fill, stream alterations or relocations, small impoundments, and water and wastewater treatment plants.

Applicants must submit a completed application with a location map, plans of the proposed construction, and the addressing of public notice. If the proposed construction lies in an area where there is no existing floodplain information, hydrologic and hydraulic analysis may need to be performed.

KDOW engineers will perform the analysis when required provided the Applicant supplies them with the floodplain geometry in the form of cross sections, preferably tabulated on an Excel Spreadsheet. This analysis determines the effects the proposed construction has on existing flood conditions and determine the expected 100-year flood heights and the delineation of the floodway (a portion of the natural floodplain that is restricted to little or no construction).

From this analysis, construction limits for fills and buildings and required elevations for finished floors or floodproofing can be provided. For all construction, especially bridges and culverts, a check is made to ensure that the project has only minimal impacts on existing flood levels. For more information, see <http://www.water.ky.gov/floodplainmanagement/floodplainconstruction/>

For more information, see www.water.ky.gov/permitting.

Case Study: Organizing and Phasing Large Projects—The Kentucky Transportation Cabinet Approach

Large construction projects should be organized via a logical sequence and phased to simplify and reduce management needs for controlling polluted runoff. This approach requires an analysis of the job site to identify work zones, activity sequences, and project phases. The KYTC has developed a procedure for organizing and phasing roadway construction that provides an excellent example of how this approach can be implemented.

Erosion control plans are developed that show existing conditions overlaid with proposed construction grades and features—roadways, shoulders, and ditches, in this case. Designers are able to identify individual drainage areas along the right-of-way that will potentially be disturbed as construction proceeds. These so-called *disturbed drainage areas* (DDAs) are easily distinguished because they simply outline drainage catchments within the project area. After the DDAs are identified, designers will calculate the disturbed and upland drainage area within each and note whether they drain via sheet flow or concentrated flow. This information provides the basis for selecting appropriate BMPs—rock checks, traps, and basins for concentrated flows, and silt fencing, brush barriers, or other sediment controls for sheet flow.



Linear construction sites require special attention to drainage within—and into—the construction zone.

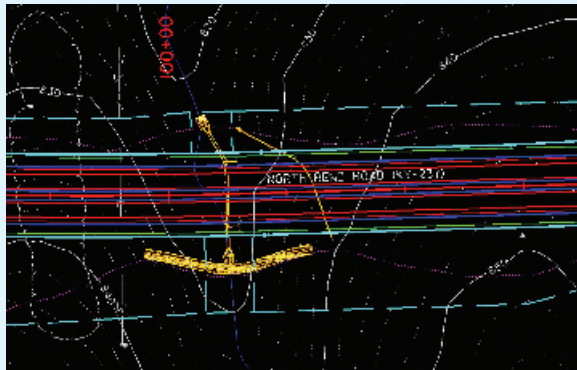

The first step in developing an erosion and sediment control plan for highway corridors is to identify disturbed drainage areas along the right-of-way by analyzing topography and general drainage patterns.

DDA area (size), flow pattern, and BMP selection are then incorporated into the site SWPPP. Traps and basins are sized to provide 3,600 cubic feet of total storage per disturbed acre. Areas that drain 10 or more acres require additional analysis to determine whether site-level controls can handle the volume of runoff (i.e., 10-year storm) that might pass through the site. This analysis could indicate that clean water diversions, a larger sediment pond, or more sediment traps installed in series are needed.

After the drainage areas have been identified, they are assigned a number and characterized according to size of disturbed area, size of upland (contributing) drainage area (if more than 10 acres), and type of drainage flow (sheet runoff or concentrated flow).

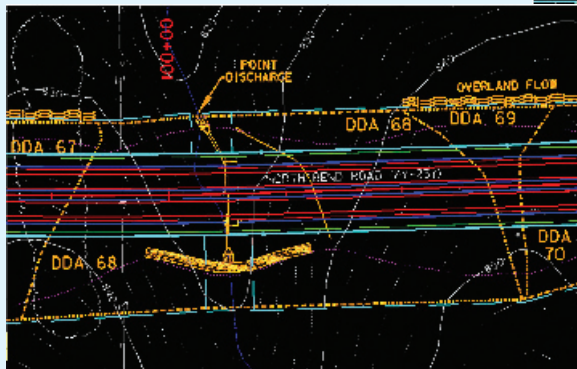
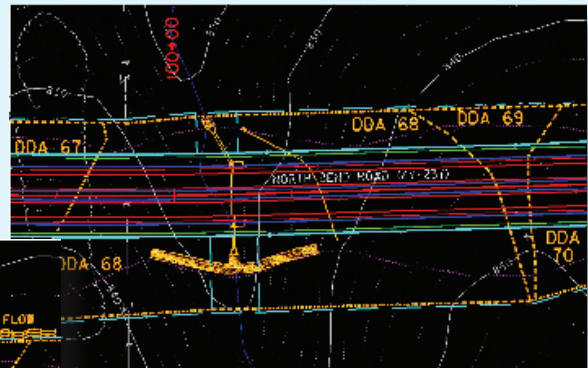

Sheet runoff from disturbed drainage areas (DDAs) is targeted for silt fencing and other sediment barriers; concentrated flows or “point discharges” are examined further to determine the best approach (e.g., sediment trap, basin).

In addition to site-level sediment management, the DDA approach also provides a basis for project phasing. DDAs along the right-of-way are designated for clearing/grubbing according to a logical analysis of how many can be adequately managed at one time. As a group of DDAs is stripped and graded and subjected to BMP controls, the next group is assessed and planned for in project stormwater KPDES permit documents (e.g., the SWPPP). KYTC phasing requirements limit the DDA total to 750,000 square feet (~17 acres).

| SECTION | DISTURBED AREA (ACRES) | MAXIMUM SEDIMENT VOLUME (CU FT) |
|---------|------------------------|---------------------------------|
| DDA 67 | 2.01 | 7,236 |
| DDA 68 | 1.37 | 4,932 |
| DDA 69 | 0.14 | 504 |
| DDA 70 | 6.72 | 24,192 |
| DDA 72 | 0.52 | 1,872 |
| DDA 73 | 8.34 | 30,024 |

Potential sediment volumes are calculated for DDAs to facilitate sizing of traps and basins.

The final step in the DDA runoff control process is to determine the type of BMPs needed for each DDA, their locations, and any special considerations beyond the standard notes information.

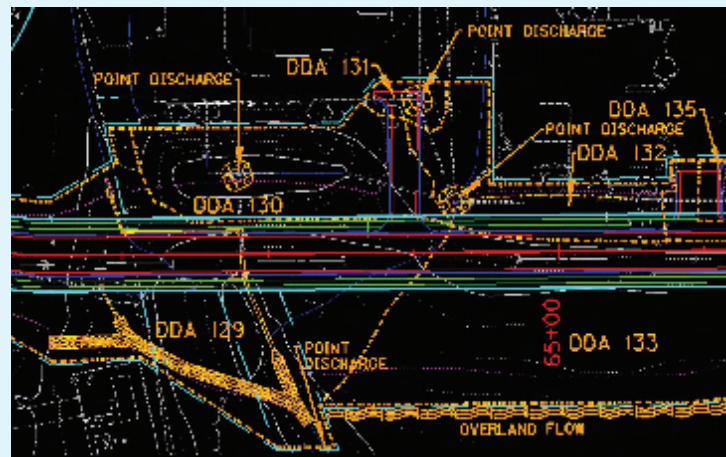

Linear construction projects, like highway corridors, require special consideration of stream crossings and the unique nature of each piece of the site drainage puzzle. The KYTC "designated drainage area" approach offers a logical process for dealing with these challenging sites. (Images courtesy of Burgess and Niple, the Kentucky Transportation Cabinet, and Tetra Tech.)

2.7 Integrating Large Projects with Watershed Management Objectives

With proper planning, design, and construction management, large development projects can have a minimal impact on water quality. The Commonwealth of Kentucky supports a wide range of mapping and other tools that provide important project planning data on drainage patterns, water quality, drinking water intakes, treatment facility discharge points, wildlife management areas, mining sites, karst flow zones, and so on. These tools are available through the Watershed Viewer and other tools posted at www.watersheds.ky.gov.

The tools are in the form of interactive global information system (GIS) maps that display a wide range of features. Interactive maps allow users to view GIS or mapped data in their home or office, thus eliminating a trip to an agency to find information. Each interactive map communicates a different theme, for example, Kentucky's Base Map, Oil and Gas Wells, Six-Year Highway Plan, Mined Out Areas, and so forth focus on a certain topic. Interactive mapping sites allow users to integrate local data sources with Internet data sources for display, query, and analysis in an easy-to-use Web browser. Any computer with an Internet connection can access interactive maps about Kentucky, but a high-speed connection is highly recommended.

There are many GIS Internet viewers active within Kentucky. They are available for many separate mapping applications and have been developed to allow the staff and the public to view maps and the associated feature attribute data. Although the viewers are very similar, the data presented is different in each instance. Map information is arranged by *layer*. Each layer can be turned on or off and can be selected as the *active* layer. The scale at which each layer becomes visible varies according to its suitability for viewing at a particular scale.

Note that when the user first accesses the site the layer menu is *collapsed*. Also make note of the Help section just below the layer listing. This Help section shows the different layer icons and what they indicate. Simply click on a closed group or folder and it will expand showing the map layers available in that group.

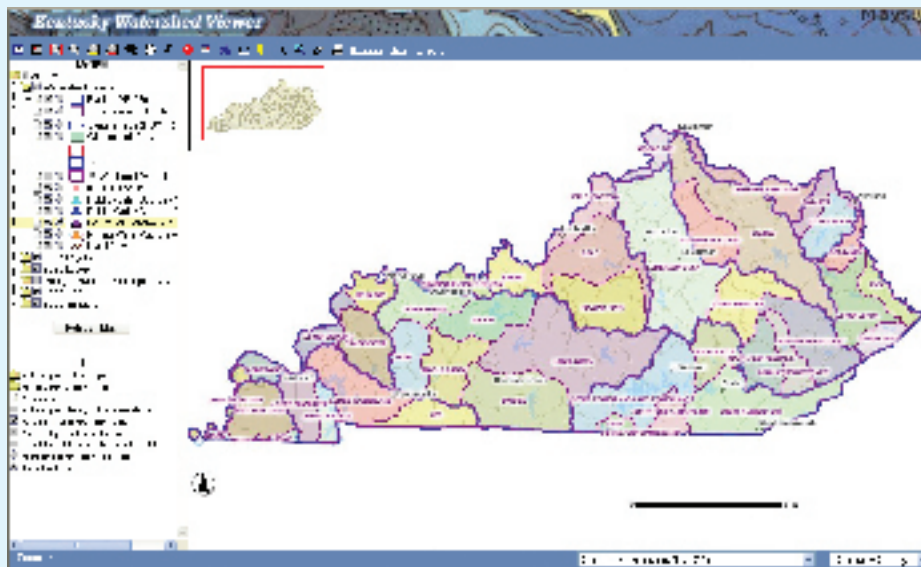

The Kentucky Division of Water, Transportation Cabinet, and other state agencies and university departments support GIS spatial viewers with overlays describing key construction planning inputs (e.g., drainage patterns, stream and river quality, soils, topography). For a full listing of these mapping tools, see the "Watershed Viewer" at www.watersheds.ky.gov. Click on "305b layers" and zoom in to view impaired waters (i.e., "not supporting").

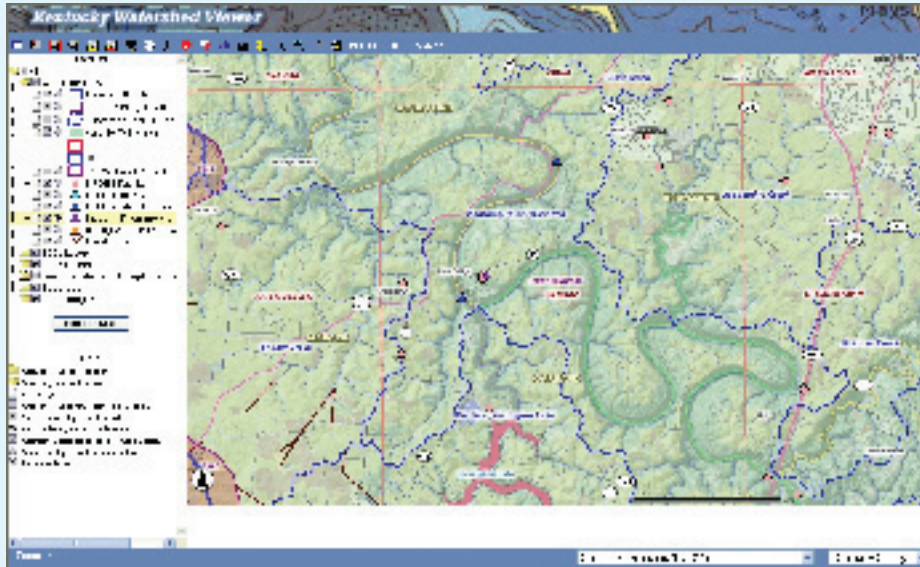

Zoom and overlay features make the GIS mapping tools a valuable asset in planning large projects. For example, designers wishing to promote on-site infiltration of runoff can consider existing topography, drainage features, and soils.

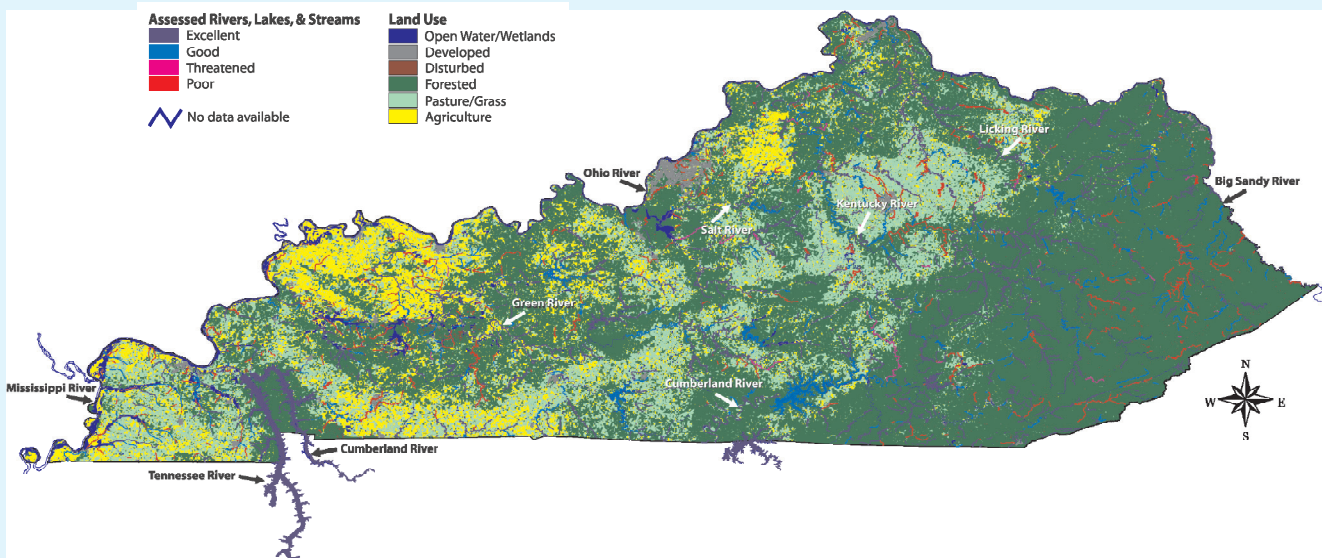

Every 2 years, the Kentucky Division of Water collects water samples from our streams, rivers, and lakes to determine which water bodies are healthy and which are polluted. This information is required by the Clean Water Act under section 305(b). In 2008, Kentucky reported that water quality in nearly half of all assessed waters was threatened or poor because of polluted runoff. The map above shows the health of Kentucky's streams, rivers, and lakes.

3. Developing a Stormwater Pollution Prevention Plan

SWPPPs describe the site and how it will be managed, list the erosion protection, sediment control, and housekeeping measures; and discuss how and when sediment and other controls will be applied as soils are exposed and site drainage is altered. SWPPPs are required for sites with a disturbed area of one acre or more, but they are a good idea for all projects. The following sequence of activities is common to the development and implementation of SWPPPs for all construction sites in Kentucky.

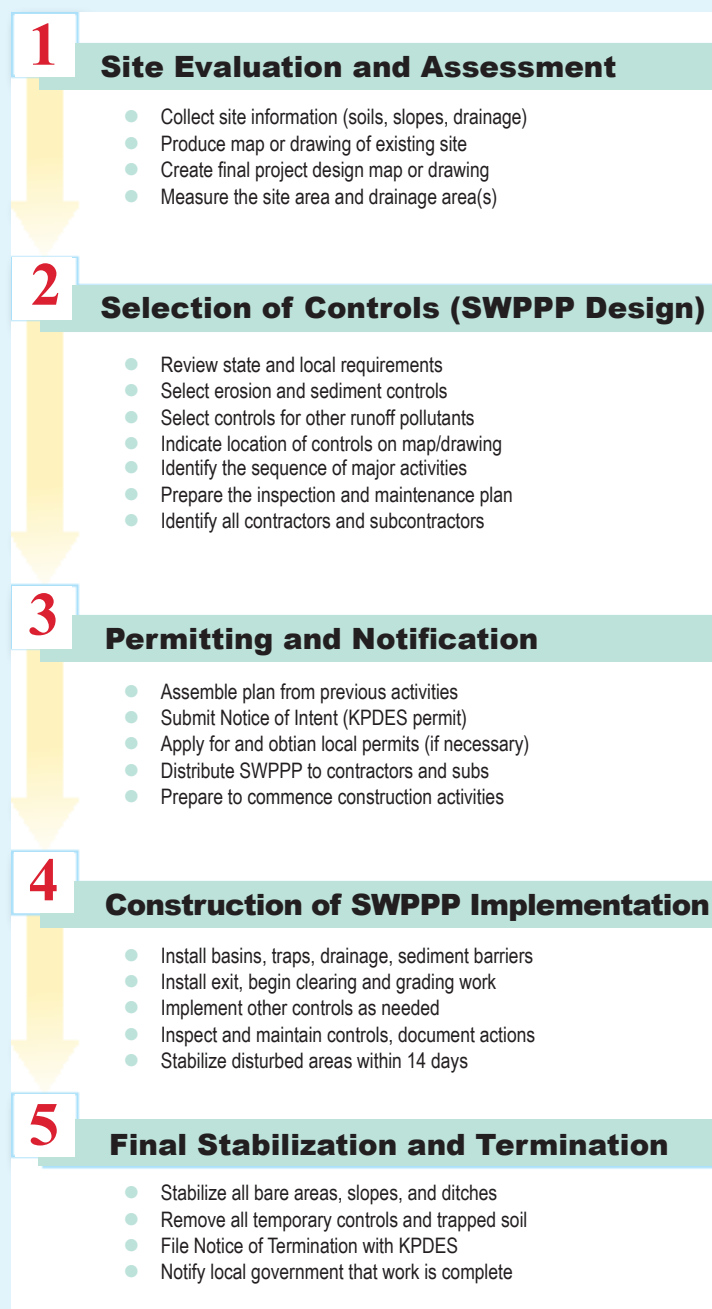

What contributes to erosion?

- Removing vegetation
- Removing topsoil and organic matter
- Reshaping the lay of the land
- Exposing subsoil to precipitation
- Failure to cover bare soil areas
- Allowing gullies to form and grow larger
- Removing vegetation along stream banks

Example site drawings and SWPPPs

For examples of site drawings and SWPPPs, see Appendix A and Appendix B. Plans are needed to comply with KPDES Stormwater Permit requirements.

Kentucky regulations require that existing vegetation must be preserved where possible. All disturbed areas of the site must be stabilized. Stabilization must begin within 14 days on areas of the site where construction activities have permanently or temporarily ceased. Stabilization practices include seeding, mulching, placing sod, planting trees or shrubs, and using geotextile fabrics and other appropriate measures, such as erosion control blankets, turf reinforcement mats, or hydromulching/hydroseeding.

The person responsible for developing the SWPPP **selects and applies relevant structural and nonstructural runoff controls, and organizes/schedules their installation, operation, and maintenance.** This task includes

- Evaluating and assessing the construction site
- Establishing goals for the site, based on local conditions
- Planning for the phases of construction activity
- Identifying erosion and sediment control BMPs
- Selecting good housekeeping or pollution prevention BMPs
- Identifying post-construction stormwater controls
- Describing plans to inspect and maintain BMPs
- Documenting certification, record-keeping, and other requirements.

The Five Ss of erosion and sediment control

- Soak it in—maximize seeding, mulching, and infiltration*
- Slow it down—don't let gullies form or grow larger*
- Sift it out—use silt fences or other sediment filters*
- Spread it around—break up concentrated flows*
- Settle it out—use inlet dams and sediment traps/basins*

SWPPPs for small sites can be fairly short and simple; those for larger sites are usually more complex because of the greater variety or conditions typically encountered. This section provides a step-by-step review of how to develop a SWPPP. The next three subsections discuss broad considerations related to plan development. Section 3.5 contains an outline for a typical SWPPP that can be used as a template for site planning and BMP selection, scheduling, installation, and maintenance.

3.1 Erosion Prevention and Sediment Control

SWPPPs address two basic types of *muddy runoff* controls that must be used on a construction site to prevent soil (and attached pollutants) from leaving the site: **erosion prevention** and **sediment control**:

- Erosion prevention BMPs are designed to **keep sediment particles in place** at a construction site (e.g., seeding, mulching, erosion blankets or mats, phasing).
- Sediment control BMPs are design to **trap sediment particles** that have become dislodged during rainfall, before the sediment leaves the construction site.

Prioritization of erosion and sediment controls for construction sites

| Practice | Cost | Effectiveness |
|---|-------------|---------------|
| Limiting disturbed areas through phasing | \$ | |
| Protecting disturbed areas through mulching and revegetation | \$ \$ | |
| Installing diversion around disturbed areas. | \$ \$ \$ | |
| Sediment removal through detention of all site drainage | \$ \$ \$ | |
| Other structural controls to treat sediment-laden flow | \$ \$ \$ \$ | |

The cheapest erosion and sediment controls are the most effective. For example, limiting the amount of bare soil by phasing your project and preserving existing vegetation are less expensive and work better than installing large stormwater control basins or ponds.

In other words, erosion prevention BMPs try to minimize the movement of soil, and sediment control BMPs remove soil particles in runoff before they leave the site or enter a waterway. Many BMPs can serve both functions if designed and implemented properly (i.e. a grassy swale can filter runoff while directing it away from a denuded area). Erosion prevention BMPs should always be used first at a construction site where practical, because they work better and are much cheaper than sediment controls. However, a combination of both types of BMPs is normally required to adequately protect water quality.

Erosion prevention

The most important thing to remember when trying to prevent erosion on a construction site is to **minimize the amount and duration of soil exposure**. Maintaining existing cover will slow runoff, protect soil, and hold it in place. Preserving existing vegetation will also save money. Identify natural landscape features to keep, such as large trees, wildflower areas, and grasslands. Plan to fit the project around these features, so they remain in place after construction is completed. Also, try to preserve the existing site drainage system as much as possible, if it is stable. Do not clear vegetation or excavate areas near streams, rivers, lakes, or wetlands without getting the required state and federal permits (see Section 2).

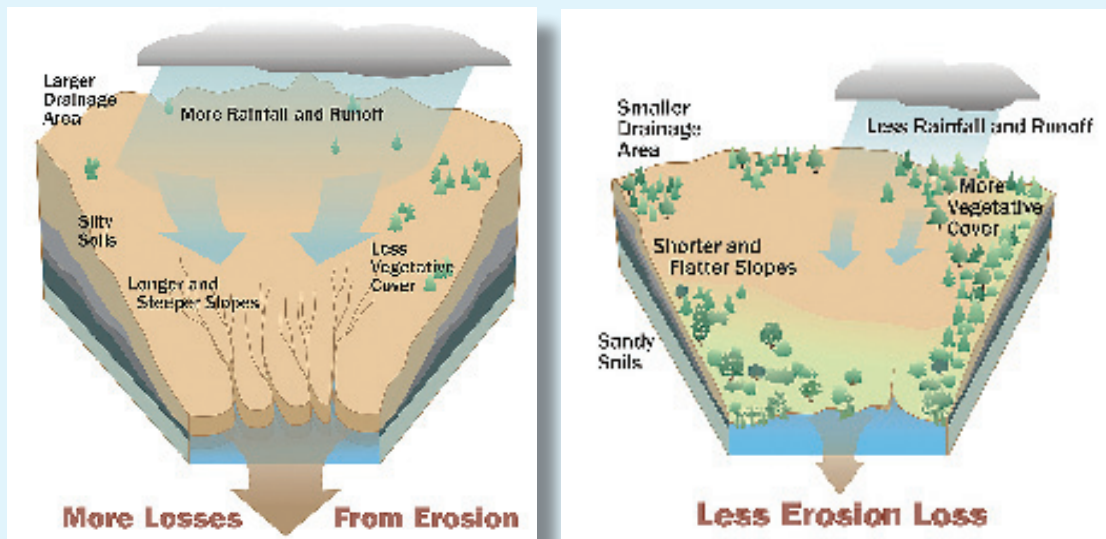

What contributes to erosion? Heavy rainfall, steep slopes, removal of most existing vegetation, and erodible soils result in higher soil losses from erosion. Lower rainfall amounts, flatter slopes, preserving existing vegetation, and less erodible soils result in lower soil loss from erosion.



Are you working in a “Stormwater Phase II City?”

Most Kentucky cities with a population of 10,000 or more have adopted new requirements for construction sites, which closely match the recommendations and information contained in this manual. For more information on the construction site erosion and sediment control procedures in specific Kentucky cities, visit www.kytc.state.ky.us/EnvAnalysis/Stormwaterquality/local_prog_links.htm

Most Kentucky cities with a population of 10,000 or more are subject to federal Stormwater Phase II requirements, which stipulate adoption of measures to manage construction site impacts and post-construction runoff.

Is a KPDES Stormwater Permit Required for Your Construction Project?

To determine if your project requires a stormwater permit for construction activities, consider the following questions:

- Will your construction project disturb one or more acres of land?
- Will your construction project disturb less than one acre of land but is part of a larger common plan of development or sale that will disturb a total of one or more acres of land?
- Will your construction project disturb less than one acre of land but is designated by the Kentucky Division of Water as a regulated construction activity?
- Will stormwater from the construction site flow to a municipal separate storm sewer system (MS4) or a ditch, swale, culvert, or pipe that eventually empties into a creek, stream, or other water of the United States?

If you have answered “Yes” to any of the first three questions AND “Yes” to the fourth question, you need a stormwater permit for your construction activities. Please note that some municipalities also are required to implement stormwater control programs; therefore, check with your municipality for its own requirements. For more information on the EPA Stormwater Program go to: www.epa.gov/npdes/stormwater

Are you responsible for getting the KPDES permit?

EPA and the Kentucky Division of Water require each party who is considered a construction site “operator” to get permit coverage by submitting a Notice of Intent to the Division of Water. The owner, developer, general contractor, and architect could all be considered “operators” and may be required to obtain permit coverage. Before obtaining permit coverage, you will need to develop a SWPPP. You must obtain permit coverage if you meet either of the following criteria:

- Do you have control of construction project plans and specifications, including the ability to make modifications to those plans and specifications?
- Do you have day-to-day control of those activities that are necessary to ensure compliance with a SWPPP for the site or other permit conditions (e.g., are you authorized to direct workers at a site to carry out activities required by the SWPPP or other permit conditions)?

If you answer “Yes” to one or both of these questions, you are likely responsible for meeting the permit requirements. (Note: the Kentucky Transportation Cabinet is the KPDES permittee for all state road projects. SWPPP development and compliance is the responsibility of KYTC and the contractor. Changes to the SWPPP are made by the contractor.)

Land disturbance should be planned in phases to minimize the amount of area denuded at any one time. A detailed analysis of cuts or fills, soils, and overall site resources is highly recommended for large projects because it can help to divide the project into logical work phases, identify resources that should remain undisturbed, and identify soil, rock and other material or resources that can be used during construction. Ideally, phased zones can be identified that roughly balance cut or fill needs while accommodating the work schedule. Balancing cuts and fills helps minimize exposure and movement of soil and keeps the *working face* of the project at a manageable level.

Once the soil has been exposed, it is critical to **stabilize the area as quickly as possible** with vegetative (i.e. temporary or permanent seeding, sod, landscaping) or non-vegetative covers (i.e. mulch, erosion blankets, pavers, gravel). Stabilizing exposed soil is the most effective means for minimizing pollutant runoff from construction activities.

Structural BMPs can be used to prevent erosion as well. Controls should be installed before grading to divert, store or control runoff to protect vulnerable or denuded areas. Ditches, swales, berms, dikes, or pipes can be used to channel flow away from disturbed areas. These same types of controls can be used to direct any muddy runoff toward sediment control BMPs for pollutant removal.

Sediment control

Sediment control BMPs remove pollutants from runoff by (1) filtering the runoff to remove particles, or (2) slowing or trapping runoff to allow heavy particles to settle out. Some types of controls do both. For example, vegetation (i.e. grassy swales, buffers) filters pollutants from runoff as it flows overland and slows the flow, allowing heavy particles to fall out.

Structural controls can be designed to **trap runoff and promote settling** of suspended sediment. Sediment control can be accomplished with a small structure such as a check dam (i.e., ditch check), or by installing a large sedimentation basin. Care should be

taken in determining the locations for sediment control measures. Structures should receive only the volume and velocity of flow specified in the design (see Section 4). In addition, it is critical that sediment controls be placed at strategic locations throughout the site to micro-manage runoff and capitalize on sediment removal opportunities before ditches or other concentrated flows leave the site. These exits are the final sediment control points. If the site drains to a storm sewer system, the storm drain inlets must be protected.

Measures to prevent tracking of mud and debris off-site are important sediment control practices as well. Properly designed and installed rocky entry or exit pads, wash racks, or regular street sweeping might be necessary prevent streets from being covered with mud.

3.2 Housekeeping and Other Control Measures

SWPPPs also address other possible sources of contaminated runoff from construction sites,



Keep construction sites well-graded, clean, and store materials properly to eliminate contaminated runoff. Wash water, fuels, and other potentially hazardous liquids should be managed appropriately.

such as paint and concrete wastes, fuels and oils, spills, groundwater contamination, trash and litter, or other issues. The discharge of many construction site pollutants can be minimized or prevented by implementing good housekeeping practices and keeping a construction site clean. Proper storage and handling of oil, grease, paints, fuel, or other potentially toxic materials used during construction is critical to protect water quality. Whenever possible, maintain and fuel vehicles and equipment away from the site to minimize spills. While it is important to have spill kits and a formal plan in place should a spill occur, it is easier and less time-consuming to prevent leaks, spills, and dumping than cleaning up afterward. During construction, address solid waste storage and disposal, portable toilets (if

needed), paint cleanup areas, wash racks, concrete washout locations, and other areas of concern to prevent polluted runoff or other harmful impacts.

3.3 Post-Construction Management of Polluted Runoff

After construction is complete, the project might still have the potential for ongoing runoff of various pollutants unless appropriate post-construction management practices are implemented. For example, pollutants such as oil and grease could be discharged from a gas station while pollutants such as nutrients and pesticides could be discharged from a plant nursery. The potential pollutants generated on-site should be considered when determining the types of runoff water management devices necessary to control pollutants discharged after construction. An effective post-construction runoff management plan requires proper site design, pollutant source controls, and treatment controls to protect water quality. This section provides a very brief summary of some approaches for ensuring that post-construction runoff does not adversely affect water quality. Note that not all of this information is included in the SWPPP, but awareness of the principles outlined below can help to control future polluted runoff and meet regulatory requirements in municipalities subject to Stormwater Phase I and II permit programs, i.e., those with regulated municipal separate storm sewer systems (see www.epa.gov/owm and click on “stormwater”).

Plan preparation: Think about the types of runoff controls you'll need. Key BMP selection factors are site size, amount of clearing/grading to be done, current land cover, steepness of slopes, and project type. See the technical specifications for planning in Chapter 4.

Site design

In the beginning stages of project planning, it is important to consider the ultimate impacts the site will have on water quality. Minimizing directly connected impervious areas and infiltrating runoff on-site rather than sending it downstream will improve the quality and decrease the quantity and velocity of stormwater runoff. In addition, runoff water management site design can promote groundwater recharge, filtration of sediment and other pollutants from runoff, and help to prevent flooding. There are a variety of measures that can be used to accomplish these goals; however, Low Impact Design (LID) is a popular site-planning approach for managing stormwater in new development. Much has been written about LID and related design approaches known as “Green Infrastructure;” it has been found to be cost effective for the developer while protecting the water quality of streams and lakes. More information on LID and Green Infrastructure can be found on EPA’s Web site at www.epa.gov/owow/nps/lid/.

The goal of LID in new development is to **maintain the predevelopment hydrologic conditions**. This is accomplished by controlling runoff near its source and using practices that promote infiltration and evaporation. The LID Site Planning Process is based on the principles below (i.e., site planning and site design is considerably more effective in reducing pollution than pollutant source controls or polluted runoff treatment).

| Design Process | Goal | Relative Effectiveness |
|--|------------------------------------|------------------------|
| 1 Site Planning and Site Design <ul style="list-style-type: none">Minimize impervious land coverage | Minimize creation of runoff | High |
| 2 Source Control <ul style="list-style-type: none">InfiltrateRetain/DetainBiofilter | Infiltrate, retain, pollute runoff | Medium |
| 3 Treatment Control <ul style="list-style-type: none">Treat and remove pollutants | Treat runoff | Low |

Site planning and design has the greatest potential for addressing polluted runoff. Source controls and treatment for polluted runoff can help, but cannot match the benefits offered by minimizing changes to the existing site drainage.

1. Identify and protect riparian areas during construction, including floodplains, stream buffers, wetlands, woodlands, steep slopes, highly permeable soils, and highly erosive soils. Kentucky requires a 25-50 ft. “no disturbance” buffer between construction activities and all surface waters.
2. Minimize clearing and grading by:
 - Restricting grading to the smallest possible area
 - Locating development away from floodplains, steep slopes, and wetlands
 - Minimizing construction easements
 - Preserving existing trees
 - Minimizing impervious surfaces
 - Disconnecting impervious surfaces to increase infiltration
3. Use hydrology as a design element when considering the location of park and play areas, potential building sites, and drainage paths.
4. Minimize total impervious area by considering
 - Roadway layouts that require less linear feet of streets
 - Narrow road sections and sidewalks on only one side of the road

- Pervious pavement for roads and parking lots
- Reduced on street parking and shared driveways
- Vertical construction of buildings to minimize roof area
- Limiting driveway widths to 9 feet
- Reduced building setback to shorten driveway length



Low impact development design seeks to capture and infiltrate runoff close to the source area. Small, strategically placed "rain gardens" and other dedicated and managed infiltration sites reduce runoff volumes and remove potential pollutants.

5. Minimize directly connected impervious areas by directing runoff from roof drains, driveway, and other paved surfaces to vegetated areas.
6. Maximize the hydrologic time of concentration by
 - Increasing overland sheet flow by letting the runoff spread out into grassy areas before reaching the stream
 - Increase the drainage flow path by directing runoff into bioretention and infiltration areas before it leaves the lot
 - Lengthen and flatten slopes on lots; increase vegetation overall
 - Use vegetated swales instead of pipes

For more information on LID and Green Infrastructure

For more on Low Impact Development and Green Infrastructure design strategies, see

www.epa.gov/owow/nps/lid/lidnatl.pdf

http://cfpub.epa.gov/npdes/home.cfm?program_id=298

For a builder's guide to low impact development, see

www.lowimpactdevelopment.org/lid%20articles/Builder_LID.pdf

www.lowimpactdevelopment.org/publications.htm

Source control

Pollutant source control (pollution prevention) measures aim to **reduce or eliminate** the sources or exposure of pollutants to prevent contaminated runoff. If pollutants are prevented from getting into runoff, the project can minimize the size and extent of post-construction control practices. Source control BMPs include general housekeeping (i.e., preventing spills, covering trashcans, and proper chemical storage), reduction of dry-weather flows (i.e., irrigation and washing of vehicles, sidewalks, or buildings) that can suspend pollutants in water, and educational efforts (i.e., storm drain stenciling, employee training programs). It is best to have a plan outlining proposed source control BMPs at the onset of the project as certain items might need to be considered or designed in advance (i.e., covered, locked trash enclosure).

Treatment and flow controls

Development of a site often changes the characteristics of the land, such as increasing imperviousness and altering drainage patterns. In addition, the ultimate use of the land can result in higher polluted discharges. Treatment controls attempt to remove pollutants from stormwater, thereby limiting the impact on water quality. Treatment controls can include infiltration devices or sites (preferred), filtration

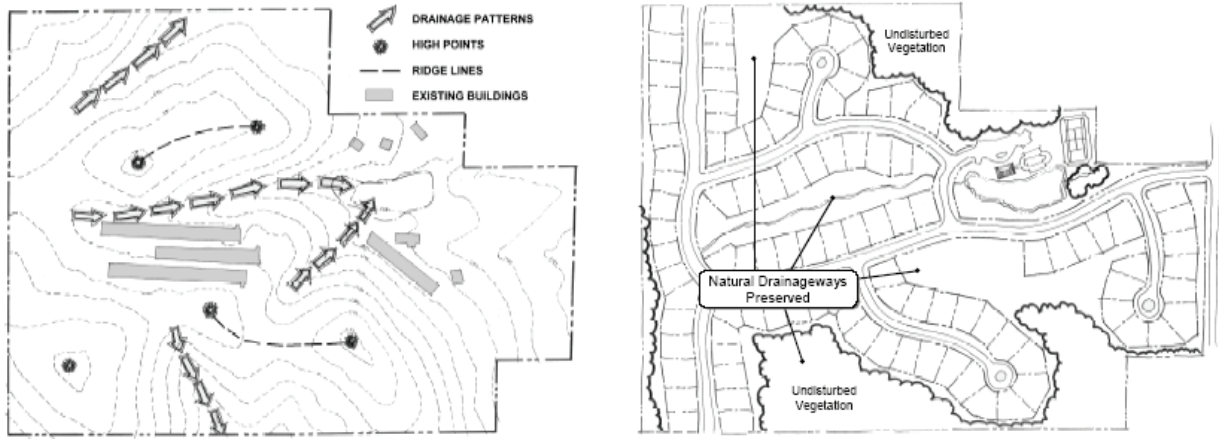
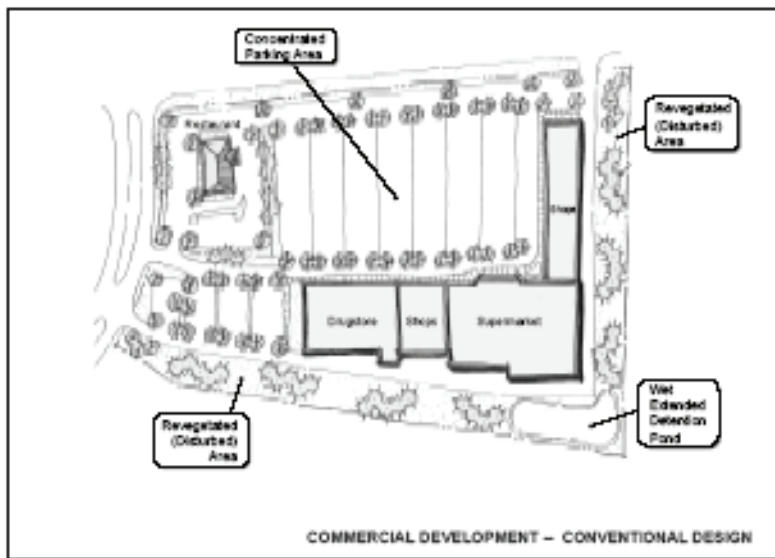

Figure 1.4.2-29 Example of a Subdivision Using Natural Drainageways for Stormwater Conveyance and Management

Fitting the project to the site: work around natural drainage features



Increasing infiltration areas, trees, and landscaping improves the “look and feel” of a development and keeps runoff clean. In this example, the parking lot has been broken up into separate units surrounded by infiltration (bioretention) areas. Trees and vegetated buffer strips have been added to improve site aesthetics, summertime cooling, and surface runoff treatment. The entire development becomes more inviting, softer, and appealing because of the increase in vegetation and reduction of large expanses of “hard” surfaces.

Figure 1.4.3-3 Comparison of a Traditional Commercial Development (above) with an Innovative Site Plan Developed Using Better Site Design Practices (below).

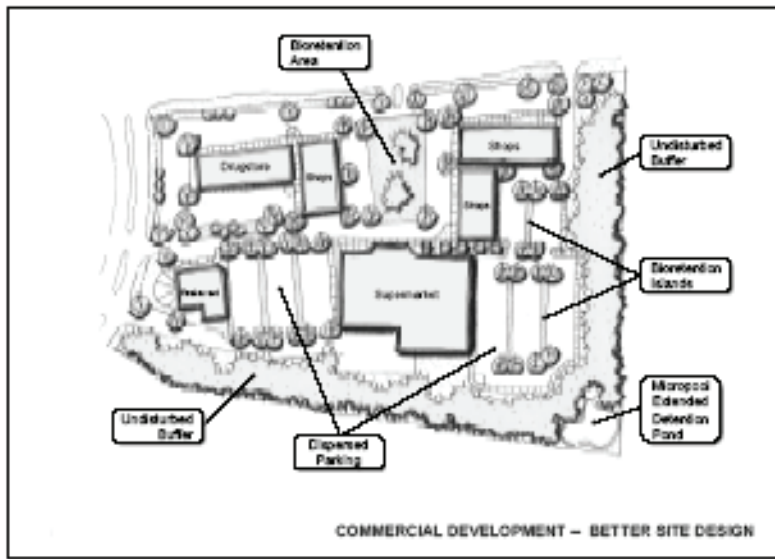

devices, and retention or detention facilities. Treatment control BMPs should be considered the final line in the post-construction stormwater management line of defense. The use of treatment controls alone can be more expensive and less effective than using a combination of site design, source controls, and treatment controls. Without site design features that reduce the amount of flow and source controls to minimize pollutants entering the runoff flow, treatment controls typically cannot perform adequately. It is critical that post-construction controls are inspected and maintained regularly if they are to function effectively over the long term.

3.4 Principles for Selecting Runoff Controls

SWPPPs identify controls that will be used during various stages of the project—clearing or stripping, grading, utility installation, facility construction, and closeout. The best and most efficient and economical approach is to **divide the project into logical phases, focus construction and runoff controls on the active work zone, and get to final grade, seed, and mulch** as soon as practicable. The table below identifies BMPs that address various objectives, which emerge as the project unfolds.

| BMP Principle | Applicable BMPs |
|---|--|
| 1. Minimize needless clearing, grading, and destruction of natural vegetation <ul style="list-style-type: none"> • <i>Establish limits of grading on plans</i> • <i>Mark or flag clearing limits in the field</i> • <i>Phase clearing and grading activities to minimize the amount of land disturbed at any one time</i> | Setbacks from Waterways Vegetated Buffer Strips |
| 2. Divert runoff and protect waterways/ wetlands <ul style="list-style-type: none"> • <i>Divert runoff away from disturbed areas</i> • <i>Create setbacks to protect waterways and wetlands</i> • <i>Establish vegetated buffer strips to help filter runoff</i> | Diversion Channel or Berm Setbacks from Waterways Vegetated Buffer Strip Stream Crossing Bioengineered Streambank Stabilization |
| 3. Protect storm drain inlets and channels <ul style="list-style-type: none"> • <i>Protect all storm drain inlets receiving runoff from the construction site</i> • <i>Create small ponding areas for silt to settle out before entering inlets and pipes</i> • <i>Stabilize ditches at pipe outlets</i> • <i>Stabilize ditches to minimize erosion</i> | Inlet Sediment Barrier Pipe Outlet Energy Dissipater Rock Lined Channel Grass Lined Channel Check Dam |
| 4. Protect slopes and disturbed areas <ul style="list-style-type: none"> • <i>Cover bare soil with vegetation</i> • <i>Use erosion control blankets on steep slopes and in ditches/channels to promote the growth of grass</i> • <i>Protect steep slopes from erosion</i> | Seed, Mulch, and Sod Topsoil Stockpiling, Dust Control Blankets and Mats Surface Roughening Slope Drain, Gabion Cellular Confinement Systems Polyacrylamides |
| 5. Establish stabilized construction entrances to minimize tracking of sediment | Construction Entrance |
| 6. Install sediment barriers on contour and at site perimeter to filter sediments | Silt Fence Brush, Rock, and Commercial Sediment Barriers |
| 7. Use dewatering practices when necessary | Dewatering Structure |
| 8. Control runoff using sediment traps or basins to remove settleable solids | Sediment Trap and Basin |

| | |
|--|--|
| <p>9. Control waste and other pollutants</p> <ul style="list-style-type: none"> • Provide cover for all chemicals, liquid products and other materials that could contaminate runoff • Provide adequate trash receptacles and debris removal • Provide concrete truck washouts • Protect fueling and equipment repair areas from runoff water | <p>Good Housekeeping Practices</p> <ol style="list-style-type: none"> Debris and Trash Management Chemical Management Concrete Waste Management Sanitary Facilities Material Delivery, Storage, and Use Employee Training Vehicle/Equipment Fueling/Maintenance Spill Prevention and Control |
| <p>10. Install, inspect, and maintain BMPs</p> <ul style="list-style-type: none"> • Train construction site workers on the purpose of BMPs, installation techniques, and maintenance requirements • Install BMPs and implement the SWPPP • Inspect BMPs every 7 days or every 14 days (and within 24 hours of every rainfall of 0.5 inch or greater) • Maintain BMPs | <p>Covered in the SWPPP:</p> <ul style="list-style-type: none"> • Identify and select appropriate BMPs • Locate and label BMP sites • Provide BMP installation schedule • Describe inspection/maintenance program |

- Preserve existing vegetation
- Divert upland runoff around exposed soil
- Seed/mulch/cover bare soil immediately
- Use sediment barriers to trap soil in runoff
- Protect slopes and channels from gullyng
- Install sediment traps and settling basins
- Preserve vegetation near all waterways

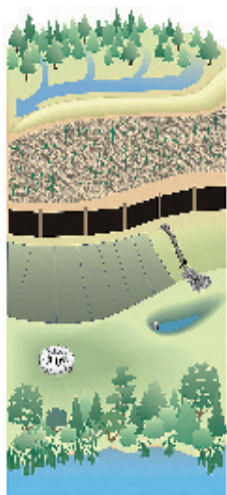

Think about how runoff will move onto, through, and off the site. This exercise will provide the information needed to identify, select, schedule, and maintain the necessary BMPs. An uphill-to-downhill assessment of the site also helps define the best approach for controlling polluted runoff.

3.5 SWPPP Contents

Several different types of controls must be considered when planning a development project. Measures must be planned to minimize erosion and remove pollutants from runoff during construction. In addition, ways to direct flows towards areas that will allow infiltration into the ground and treat runoff before it leaves a site after construction must be considered during the early phases of planning. Trying to retrofit construction or development plans to mitigate water quality impacts late in the process can be expensive and time consuming. Planning to include appropriate erosion prevention, sediment control, good housekeeping and stormwater management controls at the outset can help to ensure the protection of water quality and property as well as regulatory compliance. Section 4 of this manual provides specific examples of each type of control measure.

As discussed in Section 2.1, construction activity that disturbs one acre or more is required to obtain a KPDES permit and develop a SWPPP (**See Appendix B and C for examples**). The Kentucky Division of Water’s KYR10 Construction Stormwater General Permit contains the requirements for SWPPPs. Below are the requirements from the permit:

The permittee shall develop a Stormwater Pollution Prevention Plan (SWPPP) and implement the SWPPP at the commencement of construction disturbance. All operators working on this project are required to comply with the SWPPP or obtain separate coverage under this permit. The SWPPP shall include erosion prevention measures, sediment controls measures, and other site management practices necessary to prevent the discharge of sediment and other pollutants into waters of the Commonwealth that are adequately protective to minimize receiving waters from being degraded and failing to supportive their designated uses. These sediment controls measures including retention basins, erosion control measures, and other site management practices are required to be properly selected based on site-specific conditions, and installed and maintained to effectively minimize such discharges for storm events up to and including a 2-year, 24- hour event. Permittees are encouraged to design the site, the erosion prevention measures, sediment controls measures, and other site management practices with an eye toward minimizing post-construction stormwater runoff, including facilitating the use of low-impact technologies. The Stormwater Pollution Prevention Plan (SWPPP) shall contain the following: 1) A site description that identifies sources of pollution to stormwater discharges associated with construction activity on site; and 2) A description of the erosion prevention measures, sediment controls measures, and other site management practices

used at the site to prevent or reduce pollutants in stormwater discharges to ensure compliance with the terms and conditions of this permit. All stormwater controls shall be developed and implemented in accordance with sound practices and shall be developed specific to the site. The goal of these devices should be 80% removal of Total Suspended Solids that exceed predevelopment levels. For a common plan of development a comprehensive SWPPP shall be prepared that addresses all construction activities within the common plan of development. Each individual site operator shall be a signatory of the SWPPP and shall not conduct activities that are not consistent with the SWPPP or result in the failure or ineffectiveness of the sediment controls measures, erosion control measures, and other site management practices implemented. Otherwise, an operator not utilizing the SWPPP for the common plan of development shall seek coverage under this permit or an individual permit and develop a SWPPP for those separate activities.

Site Description—The SWPPP shall be based on an accurate assessment of the potential for generating and discharging pollutants from the site. Hence, the permit requires a description of the site and intended construction activities in the SWPPP in order to provide a better understanding of the characteristics of site runoff. At a minimum, the SWPPP shall describe the nature of the construction activity, including: a) The function of the project (e.g., box store, strip mall, shopping mall, school, electrical transmission line, oil or natural gas pipeline, factory, industrial park, residential development, transportation construction, etc.); b) The intended significant activities, presented sequentially, that disturb soil over major portions of the site (e.g., grubbing, excavation, grading); c) Estimates of the total area of the site and the total area of the site that is expected to be disturbed by excavation, grading or other activities, including off-site borrow/fill areas; and d) Provide a description of the water quality classification of the receiving water(s).



Identify drainage areas and drainage ditches and channels. Install diversions, grassed channels, sediment traps/basins, downslope sediment barriers, and rock construction entrance before beginning work.

Site Map—The SWPPP shall contain a legible site map of sufficient scale to depict the following: a) Property boundary of the project, If subdivided, show all lots and indicate on which lots construction activities will occur. b) Anticipated drainage patterns and slopes after major grading activities, including impervious structures; c) Areas of soil disturbance and areas that will not be disturbed including fill and borrow areas; d) Locations and types of sediment control measures, erosion control measures, planned stabilization measures, and other site management practices; e) Locations of surface waters, including wetlands, and riparian zones; f) Locations of karst features such as sinkholes, springs, etc.; g) Locations of discharge points; h) Locations of equipment storage areas, materials storage areas including but not limited to top soil; storage, fuels, fertilizers, herbicides, etc.; i) Location of concrete wash out areas, waste management areas, area of site egress; j) If applicable, locations where final stabilization has been accomplished and no further construction-phase permit requirements apply; and k) Other major features and potential pollutant sources. For KYTC projects which have Roadway Plans, locations of BMPs may be recorded and off-set as the BMPs are installed.

Other Industrial Activities—The SWPPP shall provide a description of any discharge associated with industrial activity other than construction (including stormwater discharges from dedicated asphalt plants, concrete plants, etc.) and the location of that activity on the construction site.

Documentation of Stormwater Controls to Reduce Pollutants—The SWPPP shall include documentation of the erosion prevention measures, sediment controls measures, and other site management practices designed to site-specific conditions that will be implemented to reduce the

pollutants in stormwater discharges from the site and assure compliance with the conditions of the permit. It is imperative that stabilization be employed as soon as practicable in critical areas. Erosion prevention measures, sediment controls measures, and other site management practices shall be properly selected based on site-specific conditions, and installed and maintained in accordance with sound sediment controls, erosion prevention, or other site management practices and relevant manufacturers' specifications. The SWPPP shall include a description of the general location of, and how and where the following erosion controls measures will be implemented: I) The

Minimize Size and Duration of Disturbance

The permittee shall at all times minimize disturbance and the period of time that the disturbed area is exposed without stabilization practices. In "critical areas," erosion prevention measures such as erosion control mats/blankets, mulch, or other measures shall be implemented on disturbed areas within 24 hours or as soon as practical.

Stabilization Requirements

Final stabilization practices on those portions of the project where construction activities have permanently ceased shall be initiated within fourteen (14) days of the date of cessation of construction activities. Temporary stabilization practices on those portions of the project where construction activities have temporarily ceased shall be initiated within fourteen (14) days of the date of cessation of construction activities.

plan to minimize disturbance and the period of time the disturbed area is exposed without stabilization practices, including: 1) Minimizing the overall area of disturbed acreage; 2) Phasing construction so that only a portion of the site is disturbed at any one time; or 3) Scheduling clearing and grading events to reduce the probability that bare soils will be exposed to rainfall. II) Managing stormwater flows on the site to avoid stormwater contact with disturbed areas by: 1) Diversion berms; 2) Conveyance channels; 3) Vegetated buffers; 4) Slope drains; or 5) Other adequately protective alternate practices. III) Using energy dissipation approaches to prevent high velocity runoff and concentrated flows that are erosive, by: 1) Use of vegetated filter strips; or 2) Other adequately protective alternate practices; IV) The practices to be used to minimize exposure of bare soils by covering and stabilization, including: 1) Vegetative stabilization with annual grasses or other plants; 2) Geotextiles; 3) Straw; 4) Rolled erosion control mats or other products; 5) Mulch; or 6) Other adequately protective alternate practices. Sediment control measures are used to control and trap sediment that is entrained in stormwater runoff. The SWPPP shall include a description of how and where the following sediment controls measures will be implemented: I) Sediment Barriers 1) Silt fences constructed with filter fabric; 2) Fiber rolls; or 3) Other adequately protective alternate practices II) Slope Protection 1) Tread tracking; 2) Erosion blankets; 3) Mulching; or 4) Other adequately protective alternate practices III) Conduit/ Ditch Protection 1) Inlet protection; 2) Outlet protection; 3) Other adequately protective alternate practices IV) Stabilizing Drainage Ditches 1) Check dams; 2) Lining deep ditches; or 3) Other protective equivalent practices V) Sediment trapping devices used to settle out sediment eroded from disturbed areas, including: 1) Sediment traps; 2) Basins; or 3) Any performance enhancement practices that will be used, such as: a) Baffles; b) Skimmers; c) Electro coagulation; d) Filtration; e) Chemically enhanced settling (e.g. polymers); or f) Other adequately protective alternate practices; or 4) Other adequately protective alternate practices. VI) Perimeter controls, such as: 1) Silt fences; 2) Berms; 3) Swales; or 4) Other adequately protective alternate practices. Construction activity generates a variety of wastes and wastewater, including concrete truck rinsate, municipal solid waste, trash, and other pollutants. Construction materials shall be handled, stored, maintained, and

disposed of properly to avoid contamination of runoff to the maximum extent practicable and as noted below. The SWPPP shall describe which practices will be implemented to manage construction and development site wastes and prevent or minimize discharges to surface water, including: a) Protecting construction materials, chemicals, and lubricants from exposure to rainfall; b) Preventing litter, construction debris, and construction chemicals from entering receiving water. c) Limiting exposure of freshly placed concrete to exposure to rainfall that results in runoff; d) Segregating stormwaters and other wastewaters from fuels, lubricants, sanitary wastes, and other chemicals such as pesticides, herbicides, and fertilizers to prevent runoff being contaminated; e) Neat and orderly storage of chemicals, pesticides, herbicides, fertilizers and fuels that are being stored on the site; f) Prompt collection and management of trash and sanitary waste; g) Prompt cleanup of spills of liquids and solid materials that could pose a pollutant risk; h) Regular removal of off-site accumulations of sediment to minimize the potential for discharge; and i) Other adequately protective alternate practices. Also to be included are a description of the intended sequence of major stormwater controls and an implementation schedule in relation to the construction process; a description of interim and permanent stabilization practices, including a schedule of their implementation; the proposed location(s)

of off-site equipment storage, material storage, waste storage and borrow/fill areas; a proposed construction schedule as a means for the operator(s) and KDOW to determine applicability and implementation status of SWPPP requirements; an explanation of practices employed to reduce pollutants from construction-related materials that are stored on site, including: a) A description of said construction materials (with updates as appropriate); b) A description of pollutant sources from areas untouched by construction; and c) A description of stormwater controls that will be implemented in those areas

Maintenance of Stormwater Controls—Erosion prevention measures, sediment controls measures, and other site management practices are required to be maintained in an effective, operating condition. The permittee shall develop a schedule of maintenance activities to ensure the proper function of these devices. The USEPA recommends that sediment control devices be maintained at no more than 1/3 capacity to allow for sediment capture.

Non-Stormwater Discharge Management—The SWPPP shall identify appropriate pollution prevention measures for each of the following eligible non-stormwater components of the discharge authorized under this permit, when combined with stormwater discharges associated with construction activity.

a) Discharges from fire-fighting activities; b) Fire hydrant flushing; c) Waters used for vehicle washing where detergents are not used; d) Water used for dust control; e) Potable water including uncontaminated water-line flushing; f) Routine external building wash down that does not use detergents; g) Pavement wash waters where spills or leaks or toxic or hazardous materials have not occurred (unless all spilled material has been removed) and where detergents are not used; h) Landscape irrigation; i) Clean, non-turbid water-well discharges of groundwater; and j. Construction dewatering provided the requirements of this permit are met.

Inspections: Permittee Conducted—Permittees shall provide for regular inspections of the site. For purposes of this part, DOW defines “regularly” to mean either I) At least once every seven (7) calendar days, or II) At least once every fourteen (14) calendar days, and within 24 hours after any storm event of 0.5 inch or greater. (DOW recommends that the permit holder perform a “walk through” inspection of the construction site before anticipated storm events.) For areas of the site that have undergone temporary or final stabilization inspections shall be conducted at least once a month until the coverage is terminated. Inspections shall be performed by personnel knowledgeable and skilled in assessing conditions at the construction site that could impact stormwater quality and assessing the effectiveness of erosion prevention measures, sediment controls measures, and other site management practices chosen to control the quality of the stormwater discharges. Inspectors shall have training in stormwater construction management such as KEPSC, CEPSC, CPSWQ, TNEPSC, CESSWI, or other similar training. Inspectors shall conduct visual inspections to determine: I) Whether erosion prevention measures, sediment controls measures, and other site management practices are: a) properly installed; b) properly maintained; c) effective in minimizing discharges to the receiving water; and II) Whether excessive pollutants are entering the drainage system. Visual inspections shall comprise, at a minimum: I) Erosion prevention measures; II) Sediment controls measures; III) Other site management

Buffer Zone

For discharges to waters categorized as High Quality Waters or Impaired Waters (Non-construction related impairment) permittees are required maintain at a minimum a 25-foot buffer zone between any disturbance and all edges of the receiving water. For discharges to waters categorized as Impaired Waters (sediment impaired, but no TMDL), permittees are required maintain at a minimum a 50-foot buffer zone between any disturbance and all edges of the receiving water. If the buffer zone between any disturbance and the edge of the receiving water cannot be maintained, an adequately protective alternate practices may be employed. The SWPPP shall explain any alternate practices and how these practices are adequately protective. Such cases include but are not limited to stream crossings and dredge and fill areas. In these cases the permittee shall minimize disturbances in the buffer zones by using hand held or other low-impact equipment.

practices and points of site egress; IV) Disturbed areas; V) Areas used for storage of materials exposed to precipitation; VI) Discharge points shall be inspected to ascertain whether erosion prevention measures, sediment controls measures, other site management practices and points of site egress are effective in preventing impacts to waters of the Commonwealth. Inspection reports shall be prepared for all inspections and shall be retained with the SWPPP. Inspection reports should include: I) The date and of inspection; II) The name and title of the inspector; III) A synopsis of weather information for the period since the last inspection (or since commencement of construction activity of the initial inspection performed) including a best estimate of the beginning of each storm event, the duration of each storm event, and the approximate amount of rainfall for each storm event (in inches); IV) Weather conditions and a description of any discharges occurring at the time of the inspection; V) Location(s) of discharges of sediment or other pollutants from the site; VI) Location(s) of sediment controls measures, erosion control measures, or other site management practices that require maintenance; VII) Location(s) of any erosion prevention measures, sediment controls measures, or other site management practices that failed to operate as designed or proved inadequate for a particular location; VIII) Location(s) where additional erosion prevention measures, sediment controls measures, or other site management practices are needed. Identify any actions taken in response to inspection findings; and identify any incidents of non-compliance with the SWPPP. If no incidents of non-compliance with the SWPPP were identified, the report shall contain a certification that the site is in compliance with the SWPPP. The inspection report shall be signed in accordance with the signatory requirements in 401 KAR 5:065, Section 1(11).

Maintaining an Updated Plan—Stormwater Pollution Prevention Plans (SWPPPs) shall be revised whenever erosion prevention measures, sediment controls measures, or other site management practices are significantly modified in response to a change in design, construction method, operation, maintenance procedure, etc., that may cause a significant effect on the discharge of pollutants to receiving waters or municipal separate storm sewer systems. The SWPPP shall be amended if inspections or investigations by site staff or by local, state, or federal officials determine that the existing site management practices are ineffective in eliminating or significantly minimizing pollutants in stormwater discharges from the construction site. If an inspection reveals design inadequacies, the site description and sediment controls measures, erosion control measures, or other site management practices identified in the SWPPP shall be revised. All necessary modifications to the SWPPP shall be made within seven (7) calendar days following the inspection. If existing practices need to be modified or if additional sediment controls measures, erosion control measures, or other practices are necessary, implementation shall be completed before the next storm event whenever practicable. If implementation before the next storm event is impracticable, the situation should be documented in the SWPPP and the changes shall be implemented as soon as practicable.

Signature, Plan Review, and Making Plans Available—The SWPPP shall be signed and certified in accordance with the signatory requirements in 401 KAR 5:065, Section 1(11). A current copy of the SWPPP shall be readily available to the construction site from the date of project initiation to the date of Notice of Termination. The person with day-to-day operational control over the plan's implementation shall keep a copy of the SWPPP readily available whenever on site (a central location accessible by all on-site operators is sufficient for sites that are part of a common plan of development). If an on-site location is unavailable to store the SWPPP when no personnel are present, notice of the plan's location shall be posted near the main entrance at the construction site.

Stormwater Pollution Prevention Plan Checklist

| Item | SWPPP Elements | Compliance | | |
|---|--|------------|------|------|
| | | Good | Fair | Poor |
| Site Description | <ul style="list-style-type: none"> Nature and type of construction activity Sequence of major soil disturbing activities (clearing, grading) Estimates of the total project area and the total disturbed area Receiving water name, water quality classification and distance Soil types and locations Construction area, time period, and general schedule Location of BMPs and schedule for installation | ○ | ○ | ○ |
| Site Map | <ul style="list-style-type: none"> Legend; property lines; existing/proposed contours; utilities Ditches, streams, sinkholes, wetlands, lakes, and critical areas Limits of construction and areas of no disturbance Trees to be preserved Existing and proposed buildings Existing and proposed paved areas Proposed pipes, inlets, and open channels Location of sheet/concentrated discharges and streams/lakes/wetlands Construction entrances Location of equipment storage areas Location of soil stockpiles and borrow/fill areas Sediment basins and sediment traps Silt fence and other sediment barriers Diversion channels or berms upgradient of site Other BMPs to be used on site Inspection and maintenance notes | ○ | ○ | ○ |
| Erosion Prevention and Sediment Control Measures | <p>Soil Stabilization (e.g., seed, mulch)</p> <ul style="list-style-type: none"> Seed and mulch specifications Bare areas idle for 14 days to be seeded/mulched <p>Perimeter Controls (e.g., silt fence, sediment ponds)</p> <ul style="list-style-type: none"> Drawings and specifications showing dimensions and materials Design criteria and calculations Sediment basin for all areas draining 10 acres of disturbed area. (Sediment storage capacity must equal 134 cubic yards per disturbed acre) <p>Stormwater Management Devices after construction is completed</p> <ul style="list-style-type: none"> Measures to prevent erosion at culvert outlets and in channels/ditches Measures to remove 80% of the TSS that exceeds predevelopment levels | ○ | ○ | ○ |
| Other Control Measures | <ul style="list-style-type: none"> Measures to prevent discharge of debris and building materials Measures to prevent off-site tracking of sediment Measure to prevent dust generation Other good housekeeping measures | ○ | ○ | ○ |
| Other State or Local Plans | <ul style="list-style-type: none"> Identify local or other regulatory requirements Demonstrate compliance with local requirements | ○ | ○ | ○ |
| Maintenance | <ul style="list-style-type: none"> Description of BMP maintenance program | ○ | ○ | ○ |
| Inspections | <ul style="list-style-type: none"> Frequency of inspection (every 7 days or every 14 days--if 14 day cycle, then also after every rainfall of 0.5" or greater) Documentation procedures for inspections Documentation procedures for making repairs to BMPs | ○ | ○ | ○ |
| Non-Stormwater Discharges | <ul style="list-style-type: none"> Pollution prevention controls (e.g. gasoline or diesel fuel spills) Good housekeeping measures Disposal procedures for trapped sediment | ○ | ○ | ○ |
| Contractor and Subcontractor | <ul style="list-style-type: none"> Name, address, and phone number of contractor & subcontractors Certification statement from each subcontractor | ○ | ○ | ○ |

3.6 Standard Notes for SWPPPs

SWPPPs are intended to organize, schedule, and guide runoff controls and site development work. The best SWPPPs will accurately and effectively forecast contractor needs for controlling runoff during clearing, grading, site stabilization, and construction. However, it is difficult to predict how a project will unfold under active field conditions—some areas scheduled for work might not be ready, subcontractors might not finish project phases on schedule, and other challenges might result in changes to the original SWPPP and schedule.

To establish some common, standard practices regarding typical grading, clearing, excavation, and fill activities, SWPPP preparers should adopt a system of standard notes for drawings and plans. These standard notes will convey important information regarding how to accommodate frequently encountered situations, like soil stockpiling, dewatering, unanticipated erosion after heavy rains, temporary sediment trap installation, and so forth. The notes will also provide clear authority for field personnel to identify, assess, and act upon conditions that could require immediate attention, such as severe rutting on slopes. The following series of standard notes should be considered for inclusion in all SWPPPs as appropriate:

- The SWPPP must be developed and implemented before any land-disturbing activities. Sediment controls such as rock site exit pads, traps, and silt fences must be installed before land clearing, excavation, or placement of fill material.
- Detention basins, if used, must be constructed first and must perform as sediment basins until the contributing drainage area is seeded and stabilized. Outlets must be modified, if necessary, to maximize detention and sediment removal during construction.
- Temporary sediment traps with rock or earthen dikes or other approved controls must be installed as needed, downgradient of heavily eroded areas as needed to prevent sediment from leaving the site.
- Install construction exit to minimize the tracking of mud, soil, and rock from construction areas onto public roadways. Soil and rock tracked onto the roadway must be removed daily.
- Soil stockpiles must be located away from streams, ponds, swales and catch basins. Stockpiles must be seeded, mulched, and adequately contained through the use of silt fence.
- All stream crossings must use properly designed low-water crossing structures authorized under a USACE Clean Water Act section 404 permit.
- Sediment-laden water encountered during trenching, boring, or other excavation activities must be pumped to a sediment trapping or filtering device and cleaned before being discharged. Discharges to storm drains, ditches, or water bodies must be covered under a KPDES permit.
- All bare soil areas not subject to active clearing, excavation, grading, or fill activities must be stabilized with temporary or permanent seeding or mulching within 14 days.
- All areas within 25 to 50 ft. of streams, rivers, lakes, wetlands, and sinkholes must be flagged as off-limits to vehicles, equipment, and soil disturbance activities.
- Good housekeeping practices must be applied to prevent contaminated runoff or other impacts from paint or concrete wastes, fuels and oils, trash and litter, or other materials.
- Silt fences, ditch checks, non-permanent sediment traps, and other temporary controls must be removed after vegetation in upgradient areas is established and ditches are stable.
- Good housekeeping measures for materials storage and handling, vehicle fueling and maintenance, spill response and cleanup, and waste management must be followed to ensure that runoff from the site is free of contaminants.

- All BMPs will be selected, installed, operated, and maintained according to KY DOW guidelines, manufacturer's requirements, or standard industry practice, as appropriate.

3.7 Inspections and Maintenance

Erosion and sediment controls must be inspected every seven days or every 14 days (if 14 day cycle then after each rain exceeding 0.5 inch). Inspections should be conducted by qualified personnel, and should follow the recommended sequence below:

Plan the inspection

Develop a checklist or report to document the inspection, including name and qualifications of the personnel making the inspection, date of the inspection, major observations relating to the implementation of the SWPPP, and any corrective actions taken. Use the SWPPP and site map to identify areas and BMPs that need to be inspected. Make sure that copies of required paperwork—permits, NOIs, the SWPPP, subcontractor certifications, prior inspection reports, USACE 404 permits, and so on—are on hand.

“Qualified personnel” means a person knowledgeable in the principles and practice of erosion, sediment, and stormwater control who possesses the skills to assess site conditions and the effectiveness of control measures selected to control the quality of stormwater discharges.

Inspect discharge locations and vehicle exits

Inspect accessible discharge locations (i.e., where ditches or sheet runoff leaves the site) to ensure that velocity dissipation devices or sediment barriers are effective in preventing significant impacts to receiving waters. Inspect all vehicle exit locations for evidence of off-site sediment tracking. Also, inspect all storm drain inlet protection controls to ensure that they are effective and note any that need maintenance.

Inspect disturbed areas

Inspect disturbed areas for evidence of pollutants entering the drainage system or moving off-site. Runoff from disturbed areas should be treated by erosion controls, sediment controls, or a combination of controls before entering the drainage system. Note any disturbed areas with excessive erosion that might need additional controls.

Inspect control measures

Inspect all control measures that are listed in the SWPPP to ensure correct operation. Inspect the control measures to evaluate whether they have been adequately installed and are effective. Note any controls that need maintenance.

Inspect material storage areas

Inspect all material storage areas exposed to precipitation for any potential for pollutants to enter the drainage system. Note any areas where potential pollutants are exposed or areas where material needs to be covered or contained.

Inspect temporary or permanent stabilized areas at least once a month

Areas that are temporarily or permanently stabilized must be inspected at least once a month to verify that erosion controls are in place. Inspections should also verify that active construction activity is not occurring in these areas. A checklist providing field indicators to assist during inspections is included in the following table.

Kentucky Construction Site Stormwater Inspection Report

| General Information | | | |
|--|--|----------------|--|
| Project Name | | | |
| KPDES Tracking No. | | Location | |
| Date of Inspection | | Start/End Time | |
| Inspector's Name(s) | | | |
| Inspector's Title(s) | | | |
| Inspector's Contact Info | | | |
| Inspector's Qualifications | | | |
| Describe present work phase | | | |
| Type of Inspection: | | | |
| <input type="checkbox"/> Regular Weekly <input type="checkbox"/> Regular Bi-Weekly <input type="checkbox"/> Pre-Storm Event <input type="checkbox"/> During Storm <input type="checkbox"/> Post-Storm Event | | | |
| Weather Information | | | |
| Has there been a storm event since the last inspection? <input type="checkbox"/> Yes <input type="checkbox"/> No | | | |
| If yes, provide: Start Date & Time: Storm Duration (hrs): Approximate Amount of Precipitation (in): | | | |
| Weather at time of this inspection? | | | |
| <input type="checkbox"/> Clear <input type="checkbox"/> Cloudy <input type="checkbox"/> Rain <input type="checkbox"/> Sleet <input type="checkbox"/> Fog <input type="checkbox"/> Snowing <input type="checkbox"/> High Winds <input type="checkbox"/> Other Temperature: _____ | | | |
| Have any discharges of sediment or other pollutants occurred since the last inspection? <input type="checkbox"/> Yes <input type="checkbox"/> No | | | |
| If yes, describe: | | | |
| Are there any discharges of sediment or pollutants at the time of inspection? <input type="checkbox"/> Yes <input type="checkbox"/> No | | | |
| If yes, describe: | | | |

Site-specific BMPs

Number the structural and non-structural BMPs identified in your SWPPP on your site map and list them below (add as many BMPs as necessary. Describe corrective actions initiated, date completed, and note the person that completed the work in the Corrective Action Log.

| | BMP Type or Name | BMP Installed? | Maintenance Required? | Corrective Action Needed and Notes |
|----|------------------|--|--|------------------------------------|
| 1 | | <input type="checkbox"/> Yes <input type="checkbox"/> No | <input type="checkbox"/> Yes <input type="checkbox"/> No | |
| 2 | | <input type="checkbox"/> Yes <input type="checkbox"/> No | <input type="checkbox"/> Yes <input type="checkbox"/> No | |
| 3 | | <input type="checkbox"/> Yes <input type="checkbox"/> No | <input type="checkbox"/> Yes <input type="checkbox"/> No | |
| 4 | | <input type="checkbox"/> Yes <input type="checkbox"/> No | <input type="checkbox"/> Yes <input type="checkbox"/> No | |
| 5 | | <input type="checkbox"/> Yes <input type="checkbox"/> No | <input type="checkbox"/> Yes <input type="checkbox"/> No | |
| 6 | | <input type="checkbox"/> Yes <input type="checkbox"/> No | <input type="checkbox"/> Yes <input type="checkbox"/> No | |
| 7 | | <input type="checkbox"/> Yes <input type="checkbox"/> No | <input type="checkbox"/> Yes <input type="checkbox"/> No | |
| 8 | | <input type="checkbox"/> Yes <input type="checkbox"/> No | <input type="checkbox"/> Yes <input type="checkbox"/> No | |
| 9 | | <input type="checkbox"/> Yes <input type="checkbox"/> No | <input type="checkbox"/> Yes <input type="checkbox"/> No | |
| 10 | | <input type="checkbox"/> Yes <input type="checkbox"/> No | <input type="checkbox"/> Yes <input type="checkbox"/> No | |
| 11 | | <input type="checkbox"/> Yes <input type="checkbox"/> No | <input type="checkbox"/> Yes <input type="checkbox"/> No | |
| 12 | | <input type="checkbox"/> Yes <input type="checkbox"/> No | <input type="checkbox"/> Yes <input type="checkbox"/> No | |
| 13 | | <input type="checkbox"/> Yes <input type="checkbox"/> No | <input type="checkbox"/> Yes <input type="checkbox"/> No | |
| 14 | | <input type="checkbox"/> Yes <input type="checkbox"/> No | <input type="checkbox"/> Yes <input type="checkbox"/> No | |
| 15 | | <input type="checkbox"/> Yes <input type="checkbox"/> No | <input type="checkbox"/> Yes <input type="checkbox"/> No | |
| 16 | | <input type="checkbox"/> Yes <input type="checkbox"/> No | <input type="checkbox"/> Yes <input type="checkbox"/> No | |
| 17 | | <input type="checkbox"/> Yes <input type="checkbox"/> No | <input type="checkbox"/> Yes <input type="checkbox"/> No | |
| 18 | | <input type="checkbox"/> Yes <input type="checkbox"/> No | <input type="checkbox"/> Yes <input type="checkbox"/> No | |
| 19 | | <input type="checkbox"/> Yes <input type="checkbox"/> No | <input type="checkbox"/> Yes <input type="checkbox"/> No | |
| 20 | | <input type="checkbox"/> Yes <input type="checkbox"/> No | <input type="checkbox"/> Yes <input type="checkbox"/> No | |

Overall Site Issues: Note BMPs, Implementation, Maintenance and Corrective Action Needs.

| BMP/activity | Installed? | Maintenance Required? | Corrective Action Needed and Notes |
|--|--|--|------------------------------------|
| Are all slopes and disturbed areas not being worked properly stabilized? | <input type="checkbox"/> Yes <input type="checkbox"/> No | <input type="checkbox"/> Yes <input type="checkbox"/> No | |
| Are streams, wetlands, mature trees, etc. protected with barriers or BMPs? | <input type="checkbox"/> Yes <input type="checkbox"/> No <input type="checkbox"/> N/A | <input type="checkbox"/> Yes <input type="checkbox"/> No <input type="checkbox"/> N/A | |
| Are perimeter controls and sediment barriers adequately installed (keyed into substrate) and maintained? | <input type="checkbox"/> Yes <input type="checkbox"/> No | <input type="checkbox"/> Yes <input type="checkbox"/> No | |
| Are discharge points and receiving waters free of any sediment deposits? | <input type="checkbox"/> Yes <input type="checkbox"/> No | <input type="checkbox"/> Yes <input type="checkbox"/> No | |
| Are storm drain inlets properly protected? | <input type="checkbox"/> Yes <input type="checkbox"/> No <input type="checkbox"/> N/A | <input type="checkbox"/> Yes <input type="checkbox"/> No <input type="checkbox"/> N/A | |
| Is the construction exit preventing sediment from being tracked into the street? | <input type="checkbox"/> Yes <input type="checkbox"/> No | <input type="checkbox"/> Yes <input type="checkbox"/> No | |
| Is trash/litter from work areas collected and placed in covered waste containers? | <input type="checkbox"/> Yes <input type="checkbox"/> No | <input type="checkbox"/> Yes <input type="checkbox"/> No | |
| Are washout facilities (e.g., paint, stucco, concrete) available, clearly marked, and maintained? | <input type="checkbox"/> Yes <input type="checkbox"/> No <input type="checkbox"/> N/A | <input type="checkbox"/> Yes <input type="checkbox"/> No <input type="checkbox"/> N/A | |
| Are vehicle and equipment fueling, cleaning, and maintenance areas free of spills, leaks, or any other material? | <input type="checkbox"/> Yes <input type="checkbox"/> No <input type="checkbox"/> N/A | <input type="checkbox"/> Yes <input type="checkbox"/> No <input type="checkbox"/> N/A | |
| Are materials that are potential stormwater contaminants stored inside or under cover? | <input type="checkbox"/> Yes <input type="checkbox"/> No | <input type="checkbox"/> Yes <input type="checkbox"/> No | |
| Are non-stormwater discharges (e.g., wash water, dewatering) properly controlled? | <input type="checkbox"/> Yes <input type="checkbox"/> No <input type="checkbox"/> N/A | <input type="checkbox"/> Yes <input type="checkbox"/> No <input type="checkbox"/> N/A | |
| Other management practices inspected or needed (explain): | | | |

Non-Compliance

Describe any incidents of non-compliance not described above:

CERTIFICATION STATEMENT

“I certify under penalty of law that this document and all attachments were prepared under my direction or supervision in accordance with a system designed to assure that qualified personnel properly gathered and evaluated the information submitted. Based on my inquiry of the person or persons who manage the system, or those persons directly responsible for gathering the information, the information submitted is, to the best of my knowledge and belief, true, accurate, and complete. I am aware that there are significant penalties for submitting false information, including the possibility of fine and imprisonment for knowing violations.”

Print name and title: _____

Signature: _____ Date: _____

4. Technical Specifications for BMPs

BMPs must be selected, installed, and maintained in a manner appropriate for both the BMP and the unique conditions of the site. This section provides technical specifications for selecting, designing, and installing (or implementing) BMPs. In general, BMPs should be designed to remove 80 percent of the sediment in the runoff and should ensure that water quality standards and public safety are not jeopardized.

It should be noted that while SWPPPs will identify the primary controls needed during each phase of construction, field personnel should be aware of how to select, adapt, operate, and maintain BMPs cited on plans or installed as a result of corrective actions stemming from field observations. The importance of this concept cannot be overstated.

4.1 BMP Selection Guidelines

General guidelines for selecting BMPs for construction sites are contained in the tables on the following pages, and in the Fact Sheets accompanying each BMP. BMPs are organized according to the following categories. Use these categories to find, scan through, and select BMPs that apply to your site:

- Site Preparation: Initial clearing and grading
- Soil Stabilization: Seeding, mulching, and sodding
- Slope Protection: Silt fences, blankets, mats, gabions
- Drainage System Controls: Inlet and outlet protection, ditches
- Sediment Traps/Basins: Small and large settling *ponds*
- Stream and Wetland Protection: Preserving and restoring waterways
- Good Housekeeping: Prevention of other types of polluted runoff

BMPs can also be selected based on their relative cost and effectiveness. In the table that follows, each BMP in the categories above is listed along with its purpose and application, relative effectiveness, and relative cost of installation and maintenance. For more details on BMP applications, including specific purpose, design criteria, construction specifications, and inspection and maintenance information, see each BMP Fact Sheet in this section. The page numbers in the table can be used to locate each Fact Sheet.

The Fact Sheets in this section are mostly focused on erosion and sediment control, but there are other types of runoff pollutants on a construction site that can be washed into nearby waterways after rain storms or during snowmelt. The table also summarizes BMP effectiveness in treating, removing, or immobilizing various pollutants found at construction sites, including sediment.

The reader is also encouraged to review the *Kentucky Erosion Prevention and Sediment Control Field Guide*. The guide describes the erosion and sediment control process, beginning with sections on pre-project planning and operational activities. The rest of the guide discusses erosion prevention and sediment control by starting at the top of the hill, above the project site, and proceeding down the slope through the bare soil area, ditches and channels,

traps and basins, and on down to the waterways below. The field guide and other information on the Kentucky stormwater program is posted at www.water.ky.gov/permitting/wastewaterpermitting/KPDES/storm/.



BMP Purpose, Effectiveness, and Relative Costs for Various Construction Site Runoff Pollutants

| Ref. No. | BMP Categories & Specific Practices | Purpose and Application | Relative Effectiveness | Relative Installation & Maintenance Costs | Sediment | Oil/Grease | Nutrients | Toxics | Waste |
|-------------------------------|--|--|-------------------------------|--|-----------------|-------------------|------------------|---------------|--------------|
| 4.3 Site Preparation | | | | | | | | | |
| 4.3.1 | Land Grading | Manage site clearing, excavation, and importation of fill material to minimize muddy runoff and preserve existing drainage system. | High | Low | ● | ○ | ● | ○ | ○ |
| 4.3.2 | Construction Exit | Keep sediment from being tracked onto public or other roadways. A rock pad of No. 2 stone is built where vehicles exit the site. | High | Low | ● | ○ | ○ | ○ | ○ |
| 4.3.3 | Temporary Diversion (Berm or Ditch) | Prevent clean runoff from flowing through disturbed areas. Clean water from upslope areas is diverted around or through the site. | High | Low | ● | ○ | ■ | ○ | ○ |
| 4.3.4 | Topsoil Stockpiling | Preserve topsoil for later use when seeding & landscaping. | High | Low | ● | ○ | ● | ○ | ○ |
| 4.3.5 | Surface Roughening | Slow the velocity of water flowing down a slope and keep the seed and mulch in place. A dozer is operated up and down the slope to create small depressions with the tracks. | Moderate | Low | ● | ○ | ● | ○ | ○ |
| 4.4 Soil Stabilization | | | | | | | | | |
| 4.4.1 | Temporary Seeding | Provide temporary vegetation and reduce erosion. Must be applied to areas where work has temporarily stopped after 14 days. | High | Low | ● | ○ | ● | ○ | ○ |
| 4.4.2 | Permanent Seeding | Provide permanent vegetation and reduce erosion. Must be applied within 14 days to areas that have reached final grade. | High | Low | ● | ○ | ● | ○ | ○ |
| 4.4.3 | Mulching | Reduce erosion, foster the growth of grass, and keep the soil moist by applying organic ground cover materials. | High | Low | ● | ○ | ● | ○ | ○ |
| 4.4.4 | Sodding | Quickly establish vegetation by using live, rooted mats of grass. | High | Low | ● | ○ | ● | ○ | ○ |
| 4.4.5 | Polyacrylamides | Reduce soil erosion by spraying the chemical binder on soil, or adding it to sediment basins to increase the settling of soil particles. | Moderate | High | ■ | ○ | ■ | ○ | ○ |
| 4.4.6 | Dust Control | Control fugitive dust emissions during dry weather on bare sites. | Moderate | High | ■ | ○ | ○ | ○ | ○ |
| Page | BMP Categories & Specific Practices | Purpose and Application | Relative Effectiveness | Relative Installation & Maintenance Costs | Sediment | Oil/Grease | Nutrients | Toxics | Waste |
| 4.5 Slope Protection | | | | | | | | | |

● BMP is very effective in treating, removing, or immobilizing the target pollutant.

■ BMP is somewhat effective in treating, removing, or immobilizing the target pollutant.

○ BMP is not effective in treating, removing, or immobilizing the target pollutant or not applicable.

BMP Purpose, Effectiveness, and Relative Costs For Various Construction Site Runoff Pollutants

| | | | | | | | | | | | | |
|---|--|---|-------------------------------|--|-------------------------------------|--------------------------|-------------------------------------|--------------------------|--------------------------|--------------------------|--------------------------|--------------------------|
| 4.5.1 | Silt Fences | Intercept sheet runoff and provide a place for water to pond, so sediment will fall out. | Moderate | Moderate | <input type="checkbox"/> | <input type="checkbox"/> | <input type="checkbox"/> | <input type="checkbox"/> | <input type="checkbox"/> | <input type="checkbox"/> | <input type="checkbox"/> | <input type="checkbox"/> |
| 4.5.2 | Brush, Rock, & Other Sediment Barriers | Intercept and slow down runoff and provide a place for water to pond, so sediment will fall out. | Moderate to high | Moderate | <input type="checkbox"/> | <input type="checkbox"/> | <input type="checkbox"/> | <input type="checkbox"/> | <input type="checkbox"/> | <input type="checkbox"/> | <input type="checkbox"/> | <input type="checkbox"/> |
| 4.5.3 | Erosion Control Blankets & Turf Reinforcement Mats | Prevent erosion & protect grass seed by applying blankets or mats to bare soil areas. Required for slopes greater than 2:1 and channel velocities greater than 5 feet per second. | High | High | <input checked="" type="checkbox"/> | <input type="checkbox"/> | <input checked="" type="checkbox"/> | <input type="checkbox"/> | <input type="checkbox"/> | <input type="checkbox"/> | <input type="checkbox"/> | <input type="checkbox"/> |
| 4.5.4 | Temporary Slope Drains | Transport water down the face of a slope without causing erosion. A pipe or concrete lined channel can be used. | Moderate | High | <input type="checkbox"/> | <input type="checkbox"/> | <input type="checkbox"/> | <input type="checkbox"/> | <input type="checkbox"/> | <input type="checkbox"/> | <input type="checkbox"/> | <input type="checkbox"/> |
| 4.5.5 | Gabion Baskets and Mattresses | Stabilize steep slopes at the inlet or outlet of a pipe or on a stream bank. Should be used only if vegetation or erosion control blankets/mats will not work. | High | High | <input type="checkbox"/> | <input type="checkbox"/> | <input type="checkbox"/> | <input type="checkbox"/> | <input type="checkbox"/> | <input type="checkbox"/> | <input type="checkbox"/> | <input type="checkbox"/> |
| 4.5.6 | Cellular Confinement Systems | Stabilize steep slopes. Should be used only if vegetation or erosion control blanket/mats will not work. | High | High | <input checked="" type="checkbox"/> | <input type="checkbox"/> | <input type="checkbox"/> | <input type="checkbox"/> | <input type="checkbox"/> | <input type="checkbox"/> | <input type="checkbox"/> | <input type="checkbox"/> |
| 4.6 Drainage System Controls | | | | | | | | | | | | |
| 4.6.1 | Curb Inlet Sediment Barrier | Create a small ponding area for soil to settle out at the front of the inlet using rock bags or commercial products. | Moderate | Moderate | <input type="checkbox"/> | <input type="checkbox"/> | <input type="checkbox"/> | <input type="checkbox"/> | <input type="checkbox"/> | <input type="checkbox"/> | <input type="checkbox"/> | <input type="checkbox"/> |
| 4.6.2 | Drop Inlet Sediment Barrier | Create a small ponding area for soil to settle out around the perimeter of the drop inlet using rock, filter fabric, or other products. | Moderate | Moderate | <input type="checkbox"/> | <input type="checkbox"/> | <input type="checkbox"/> | <input type="checkbox"/> | <input type="checkbox"/> | <input type="checkbox"/> | <input type="checkbox"/> | <input type="checkbox"/> |
| 4.6.3 | Culvert Inlet Sediment Barrier | Create a small ponding area for soil to settle out at the culvert entrance using rock or products. | Moderate | Moderate | <input type="checkbox"/> | <input type="checkbox"/> | <input type="checkbox"/> | <input type="checkbox"/> | <input type="checkbox"/> | <input type="checkbox"/> | <input type="checkbox"/> | <input type="checkbox"/> |
| 4.6.4 | Culvert Outlet Energy Dissipator | Reduce the velocity of water exiting a pipe using a rock apron. | Moderate | High | <input checked="" type="checkbox"/> | <input type="checkbox"/> | <input type="checkbox"/> | <input type="checkbox"/> | <input type="checkbox"/> | <input type="checkbox"/> | <input type="checkbox"/> | <input type="checkbox"/> |
| 4.6.5 | Rock Lined Ditches and Channels | Prevent channel erosion using rock installed on filter fabric. | High | High | <input checked="" type="checkbox"/> | <input type="checkbox"/> | <input type="checkbox"/> | <input type="checkbox"/> | <input type="checkbox"/> | <input type="checkbox"/> | <input type="checkbox"/> | <input type="checkbox"/> |
| Page | BMP Categories & Specific Practices | Purpose and Application | Relative Effectiveness | Relative Installation & Maintenance Costs | Sediment | Oil/Grease | Nutrients | Toxics | Waste | | | |
| 4.6.6 | Grass Lined Ditches and Channels | Prevent channel erosion using vegetation protected by mulch, blankets, or turf mats. | High | High | <input checked="" type="checkbox"/> | <input type="checkbox"/> | <input type="checkbox"/> | <input type="checkbox"/> | <input type="checkbox"/> | <input type="checkbox"/> | <input type="checkbox"/> | <input type="checkbox"/> |
| 4.6.7 | Check Dams for Ditches and Channels | Reduce the channel velocity, prevent channel erosion, and trap sediment. | Low | High | <input type="checkbox"/> | <input type="checkbox"/> | <input type="checkbox"/> | <input type="checkbox"/> | <input type="checkbox"/> | <input type="checkbox"/> | <input type="checkbox"/> | <input type="checkbox"/> |
| 4.7 Sediment Traps and Basins | | | | | | | | | | | | |
| <ul style="list-style-type: none"> <input checked="" type="checkbox"/> BMP is very effective in treating, removing, or immobilizing the target pollutant. <input type="checkbox"/> BMP is somewhat effective in treating, removing, or immobilizing the target pollutant. <input type="checkbox"/> BMP is not effective in treating, removing, or immobilizing the target pollutant or not applicable. | | | | | | | | | | | | |

BMP Purpose, Effectiveness, and Relative Costs For Various Construction Site Runoff Pollutants

| | | | | | | | | | | | | | |
|---|--|---|-------------------------------|--|--------------------------|--------------------------|--------------------------|--------------------------|--------------------------|--------------------------|--------------------------|--------------------------|--------------------------|
| 4.7.1 | Temporary Sediment (Silt) Traps | Trap sediment by collecting it in a small depression or bermed area and slowly discharging it. | Moderate | Moderate | <input type="checkbox"/> | <input type="checkbox"/> | <input type="checkbox"/> | <input type="checkbox"/> | <input type="checkbox"/> | <input type="checkbox"/> | <input type="checkbox"/> | <input type="checkbox"/> | <input type="checkbox"/> |
| 4.7.2 | Sediment (Detention) Basins | Trap sediment by collecting it in a basin and slowly discharging it. Required for disturbed drainage areas of more than 10 acres. | Moderate to high | High | <input type="checkbox"/> | <input type="checkbox"/> | <input type="checkbox"/> | <input type="checkbox"/> | <input type="checkbox"/> | <input type="checkbox"/> | <input type="checkbox"/> | <input type="checkbox"/> | <input type="checkbox"/> |
| 4.7.3 | Dewatering Devices | Remove sediment from muddy water collected on-site from runoff or groundwater. | High | Moderate | <input type="checkbox"/> | <input type="checkbox"/> | <input type="checkbox"/> | <input type="checkbox"/> | <input type="checkbox"/> | <input type="checkbox"/> | <input type="checkbox"/> | <input type="checkbox"/> | <input type="checkbox"/> |
| 4.8 Stream & Wetland Protection | | | | | | | | | | | | | |
| 4.8.1 | Buffer Zones | Protect existing vegetation along the banks of a creek, wetland, lake, river, or sinkhole to filter runoff and trap pollutants. | High | Low | <input type="checkbox"/> | <input type="checkbox"/> | <input type="checkbox"/> | <input type="checkbox"/> | <input type="checkbox"/> | <input type="checkbox"/> | <input type="checkbox"/> | <input type="checkbox"/> | <input type="checkbox"/> |
| 4.8.2 | Filter Strips | Create a vegetative buffer strip along the banks of a creek, wetland, lake, river, or sinkhole to filter runoff and trap pollutants. | High | Moderate | <input type="checkbox"/> | <input type="checkbox"/> | <input type="checkbox"/> | <input type="checkbox"/> | <input type="checkbox"/> | <input type="checkbox"/> | <input type="checkbox"/> | <input type="checkbox"/> | <input type="checkbox"/> |
| 4.8.3 | Temporary Stream Crossing | Protect stream banks and bottoms from erosion by constructing a span of culverts for vehicles to use in crossing a stream. | Moderate | Moderate | <input type="checkbox"/> | <input type="checkbox"/> | <input type="checkbox"/> | <input type="checkbox"/> | <input type="checkbox"/> | <input type="checkbox"/> | <input type="checkbox"/> | <input type="checkbox"/> | <input type="checkbox"/> |
| 4.8.4 | Bioengineering: Live Staking | Stabilize a stream bank with vegetation by driving live stakes such as willows into the soil to grow. | Moderate | High | <input type="checkbox"/> | <input type="checkbox"/> | <input type="checkbox"/> | <input type="checkbox"/> | <input type="checkbox"/> | <input type="checkbox"/> | <input type="checkbox"/> | <input type="checkbox"/> | <input type="checkbox"/> |
| Page | BMP Categories & Specific Practices | Purpose and Application | Relative Effectiveness | Relative Installation & Maintenance Costs | Sediment | Oil/Grease | Nutrients | Toxics | Waste | | | | |
| 4.8.5 | Bioengineering: Wattles (Live Fascines) | Stabilize a stream bank with vegetation by binding live branches into long bundles and placing them into trenches along the slope to sprout and grow. | Moderate | High | <input type="checkbox"/> | <input type="checkbox"/> | <input type="checkbox"/> | <input type="checkbox"/> | <input type="checkbox"/> | <input type="checkbox"/> | <input type="checkbox"/> | <input type="checkbox"/> | <input type="checkbox"/> |
| 4.8.6 | Bioengineering: Brushlayering | Stabilize a stream bank with vegetation by inserting live branches into the soil to sprout and grow. | Moderate | High | <input type="checkbox"/> | <input type="checkbox"/> | <input type="checkbox"/> | <input type="checkbox"/> | <input type="checkbox"/> | <input type="checkbox"/> | <input type="checkbox"/> | <input type="checkbox"/> | <input type="checkbox"/> |
| 4.9 Good Housekeeping & Other Controls | | | | | | | | | | | | | |
| 4.9.1 | Materials Delivery, Storage, and Use | Safely handle materials that might become potential pollutants. | High | Low | <input type="checkbox"/> | <input type="checkbox"/> | <input type="checkbox"/> | <input type="checkbox"/> | <input type="checkbox"/> | <input type="checkbox"/> | <input type="checkbox"/> | <input type="checkbox"/> | <input type="checkbox"/> |
| 4.9.2 | Spill Prevention and Control | Prevent and contain spills of oil, fuel, paint, fertilizers, or other liquids. | High | Low | <input type="checkbox"/> | <input type="checkbox"/> | <input type="checkbox"/> | <input type="checkbox"/> | <input type="checkbox"/> | <input type="checkbox"/> | <input type="checkbox"/> | <input type="checkbox"/> | <input type="checkbox"/> |

BMP is very effective in treating, removing, or immobilizing the target pollutant.

BMP is somewhat effective in treating, removing, or immobilizing the target pollutant.

BMP is not effective in treating, removing, or immobilizing the target pollutant or not applicable.

BMP Purpose, Effectiveness, and Relative Costs For Various Construction Site Runoff Pollutants

| | | | | | | | | | |
|-------|-----------------------------------|---|------|----------|-------------------------------------|-------------------------------------|-------------------------------------|-------------------------------------|-------------------------------------|
| 4.9.3 | Vehicle and Equipment Maintenance | Minimize or eliminate runoff pollutants associated with operation of vehicles and equipment on the site. | High | Low | <input checked="" type="checkbox"/> | <input type="checkbox"/> | <input checked="" type="checkbox"/> | <input type="checkbox"/> | <input checked="" type="checkbox"/> |
| 4.9.4 | Debris and Trash Management | Provide waste storage containers on-site to minimize the amount of debris that is blown or washed off the site. | High | Moderate | <input type="checkbox"/> | <input type="checkbox"/> | <input type="checkbox"/> | <input type="checkbox"/> | <input checked="" type="checkbox"/> |
| 4.9.5 | Hazardous Waste Management | Provide containers for storing chemicals to prevent leaks and spillage. | High | Low | <input type="checkbox"/> | <input type="checkbox"/> | <input checked="" type="checkbox"/> | <input type="checkbox"/> | <input checked="" type="checkbox"/> |
| 4.9.6 | Concrete Waste Management | Provide areas where trucks can dump concrete waste so that it does not wash into pipes or streams. | High | Low | <input checked="" type="checkbox"/> | <input type="checkbox"/> | <input type="checkbox"/> | <input type="checkbox"/> | <input checked="" type="checkbox"/> |
| 4.9.7 | Sanitary Facilities | Provide permanent or portable sanitary facilities. | High | Moderate | <input type="checkbox"/> | <input type="checkbox"/> | <input type="checkbox"/> | <input checked="" type="checkbox"/> | <input checked="" type="checkbox"/> |
| 4.9.8 | Employee Training | Familiarize employees with overall program of runoff controls. | High | Moderate | <input checked="" type="checkbox"/> | <input checked="" type="checkbox"/> | <input checked="" type="checkbox"/> | <input checked="" type="checkbox"/> | <input checked="" type="checkbox"/> |

BMP is very effective in treating, removing, or immobilizing the target pollutant.

BMP is somewhat effective in treating, removing, or immobilizing the target pollutant.

















BMP is not effective in treating, removing, or immobilizing the target pollutant or not applicable.









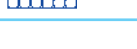



4.2 BMP Map and Plan Symbols

SWPPPs contain information on site runoff management controls (i.e., BMPs). Much of the information is descriptive, but SWPPPs also include maps and plans of the site, showing pre-construction site conditions (e.g., topography, drainage, land cover), the BMPs that will be applied during construction (e.g., silt fences, sediment traps/basins, ditches), and the final project (e.g., drainage, roads, buildings).

The symbols that follow are used to denote specific activities and structural controls that are described in this section of the *BMP Planning and Technical Specifications Manual*. Each symbol corresponds to a Fact Sheet on the BMP containing information on the definition, purpose, design criteria, construction specifications, and inspection or maintenance requirements. The symbols are also depicted on each Fact Sheet—they should be used on construction site plans to indicate where specific runoff control BMPs will be sited or applied.

Symbols Used to Denote BMPs

| Ref. No. | BMP Categories and Specific Practices | Symbol |
|------------|--|---|
| 4.3 | Site Preparation | |
| 4.3.1 | Land Grading |  |
| 4.3.2 | Construction Exit |  |
| 4.3.3 | Temporary Diversion (Berm or Ditch) |  |
| 4.3.4 | Topsoil Stockpiling |  |
| 4.3.5 | Surface Roughening |  |
| 4.4 | Soil Stabilization | |
| 4.4.1 | Temporary Seeding |  |
| 4.4.2 | Permanent Seeding |  |
| 4.4.3 | Mulching |  |
| 4.4.4 | Sodding |  |
| 4.4.5 | Polyacrylamides |  |
| 4.4.6 | Dust Control |  |
| 4.5 | Slope Protection | |
| 4.5.1 | Silt Fences |  |
| 4.5.2 | Brush, Rock, and Other Sediment Barriers |  |
| 4.5.3 | Erosion Control Blankets and Turf Reinforcement Mats |  |
| 4.5.4 | Temporary Slope Drains |  |
| 4.5.5 | Gabion Baskets and Mattresses |  |
| 4.5.6 | Cellular Confinement Systems |  |
| 4.6 | Drainage System Controls | |

| Ref. No. | BMP Categories and Specific Practices | Symbol |
|------------|--|---|
| 4.6.1 | Curb Inlet Sediment Barrier |  |
| 4.6.2 | Drop Inlet Sediment Barrier |  |
| 4.6.3 | Culvert Inlet Sediment Barrier |  |
| 4.6.4 | Culvert Outlet Energy Dissipator |  |
| 4.6.5 | Rock Lined Ditches and Channels |  |
| 4.6.6 | Grass Lined Ditches and Channels |  |
| 4.6.7 | Check Dams for Ditches and Channels |  |
| 4.7 | Sediment Traps and Basins | |
| 4.7.1 | Temporary Sediment (Silt) Traps |  |
| 4.7.2 | Sediment (Detention) Basins |  |
| 4.7.3 | Dewatering Devices |  |
| 4.8 | Stream and Wetland Protection | |
| 4.8.1 | Buffer Zones |  |
| 4.8.2 | Filter Strips |  |
| 4.8.3 | Temporary Stream Crossing |  |
| 4.8.4 | Bioengineering: Live Staking |  |
| 4.8.5 | Bioengineering: Wattles (Live Fascines) |  |
| 4.8.6 | Bioengineering: Brushlayering |  |
| 4.9 | Good Housekeeping / Other Stormwater Controls | |
| 4.9.1 | Materials Delivery, Storage, and Use |  |
| 4.9.2 | Spill Prevention and Control |  |
| 4.9.3 | Vehicle and Equipment Maintenance |  |
| 4.9.4 | Debris and Trash Management |  |
| 4.9.5 | Hazardous Waste Management |  |
| 4.9.6 | Concrete Waste Management |  |
| 4.9.7 | Sanitary Facilities |  |
| 4.9.8 | Employee Training |  |
| 4.9.9 | Groundwater Protection |  |

Source: These BMP symbols are based on those used by the Kentucky MS4 Workgroup, Louisville-Jefferson County Metropolitan Sewer District, and Mapping Symbols and Nomenclature for Erosion and Sediment Control Plans for Land Disturbing Activities (ANSI/ASAE S422 MAR95), published by the American National Standards Institute and the American Society of Agricultural and Biological Engineers.

4.3 Site Preparation

Initial clearing and grading work on a site requires attention to a fairly common set of general goals:

- Minimize the extent and duration of site disturbance, and maintain existing vegetation as much as possible
- Keep the existing site drainage system - including nearby vegetation - intact as much as possible
- Limit the number of access points to the site to control off-site mud tracking
- Phase and sequence construction activities by dividing the project into logical work zones
- Locate temporary and permanent soil disposal areas, haul roads, and construction staging areas to minimize erosion, sediment transport, and disturbance to existing vegetation
- Install sediment barriers and controls before land clearing and grading wherever possible
- Get to final grade, seed and mulch as soon as you can



Planning the clearing, grubbing, and site preparation work is necessary, especially for larger sites. Written plans—even very basic ones—help to ensure that everyone understands where the active work zones are, various activity phases, and the schedule.

Construction site work includes clearing, grading, and preparing the site for built features like roads, utilities, buildings, parking lots, and the site drainage system. This section covers a broad range of site preparation tasks including land grading, installation of the construction exit, topsoil storage, identifying buffer zones around drainage features, and initial preparation of soil surfaces by roughening.



Contractors and equipment operators should understand erosion control plans developed by engineers and be prepared to adapt the controls as the job progresses. Key control points are areas of concentrated runoff and sheet runoff. Make sure the design, location, schedule, installation, and maintenance of BMPs is logged in the KPDES permit files if the site has a disturbed area of one acre or more.

For more information about designing construction projects that cost less and minimize water resource impacts, see the *Low Impact Development Design Strategies* guide posted at www.epa.gov/owow/nps/lid/lidnatl.pdf, or see the *Best Management Practices Manual for Erosion Prevention and Sediment Control* published by the Kentucky MS4 Work Group, posted at www.bgky.org/publicworks/planningdesign/stormwater/bmpmanual/php.

The normal sequence for basic site preparation work begins with the installation of controls before clearing and excavation work and ends with all bare areas covered with grass, gravel, or built surfaces, and stable ditches with functioning stormwater systems (see table that follows).

Typical Construction Phasing Schedule for Site Preparation Work

| Construction Activity | Scheduling Considerations |
|--|--|
| Identify work zones and construction phases by analyzing proposed cut/fill work, location of proposed structures, site conditions, and site resources | Construction phase and work zone identification will ensure that land clearing and grading exposes a minimum amount of soil at any one time. |
| Identify and flag off areas to be protected, such as 25 to 50 ft buffer zones near creeks or sinkholes, drainage features, vegetated filter strips, mature trees, and so on. | All areas should be flagged and posted before land clearing and grading begins. Disturbed areas within 25 ft of streams, wetlands, and sinkholes must be stabilized within 24 hrs. |
| Install construction entrance/exit and designate vehicle parking areas | First land disturbing activity. Use geotextile liner under rock to maintain effectiveness; stabilize bare areas as soon as possible. |
| Install upgradient diversion swales or berms. | Seed and mulch as soon as construction of swales or berms is completed. |
| Size and install sediment barriers (e.g., silt fences), sediment traps, sediment basins, and outlet protection. | Install principal sediment basin(s) first, if possible; install other basins and traps as needed during clearing/grading or construction. |
| Install inlet protection dams, dikes, filters, screens, and such. | Applies to all curb, drop, pipe, or other inlets. |
| Construct drainage / runoff conveyance system; stabilize ditches and culvert outlets. | Seed and mulch as soon as possible. Use triple seeding (see seeding rates in Section 4.4.1) in ditches, and blankets/mats as necessary. Ensure that drainage entering streams or other waterbodies does not cause sedimentation. |
| Begin clearing, grubbing, and grading. | Strip and grade areas only as needed. Get to final grade and apply seed and mulch as soon as possible. Direct runoff toward appropriate controls; install new controls as needed. |
| Stabilize bare areas after final grade is reached. | Apply temporary or permanent seed, mulch, or other controls as soon as work is completed, but no later than 14 days after grading work in each area is finished. |
| Construct roads, buildings, parking lots and install utilities. | Install runoff controls as needed to deal with muddy runoff, rutting, and such. |
| Install landscaping and other final features. | Stabilize all bare areas and ditches. Remove all temporary controls. |
| Maintenance | Inspect and maintain controls weekly or every 14 days (if 14 day cycle then also after each rain of 0.5 inch or more). |



SWPPP preparers and work crews should understand that controls change as the site is graded and construction proceeds. For example, fiber rolls (logs) can control sediment along curbs and roads in relatively flat residential developments, rather than silt fences, which function well in large areas of sheet runoff but are often moved or damaged on small lot applications.

Designating a logical progression for active project work zones and phasing work within those zones helps to minimize the area requiring erosion and sediment controls. Try to match cut and fill needs to minimize disturbed area and material handling.



4.3 Site Preparation

4.3.1 Land Grading



The goal for land grading is to install necessary controls before clearing or cut/fill work, then get to final grade and seed/mulch as quickly as possible. Protect slopes and concentrated flow areas with extra controls as needed.



Definition

Operations that remove vegetation—such as clearing and grubbing—and reshape the surface of the land through excavation or placement of fill material.

Purpose

Land grading serves to construct designed site drainage features, achieve site grades necessary for construction of roads, buildings, parking lots, and other site features.

Design Criteria

- All borrow and fill or disposal areas should be noted on the SWPPP.
- A phased clearing and grading schedule that minimizes the extent of the denuded areas and minimizes the length of time the areas are exposed should be developed and followed.
- Existing drainage features (e.g., swales, ditches, channels) and the vegetation nearby should be preserved wherever possible.
- Finished cut and fill slopes to be vegetated should not be steeper than 3H:1V unless erosion control blankets or turf reinforcement mats are used.
- Cuts or fills should not be so close to property lines as to endanger adjoining property—adequate protection against erosion, sedimentation, slippage, settlement, subsidence, and other damage must be implemented.
- Subsurface drainage should be provided to areas having high water tables to intercept seepage that might affect slope stability.
- Ditches and other drainage system features should be designed to safely convey increased runoff from cleared or developed areas without causing downstream channel aggradation, degradation, or increased off-site flooding.
- The site should be graded to direct flows to appropriate BMPs or other controls.
- Temporary structural controls (e.g., silt fencing, ditch checks, inlet dikes) installed during construction must be designed to accomplish maximum stabilization and control of erosion and sedimentation and must be installed, maintained, and removed according to the specifications set forth in this manual.

- All permanent structural controls, including drainage facilities such as channels, storm sewer inlets, and detention basins, must be designed according to the standards set forth in this manual.

Construction Specifications

- Drainage system controls (e.g., sediment traps/basins, ditches) and perimeter controls (silt fences, construction exit) should be installed before land grading.
- No fill may be placed where it can slide or wash onto adjoining property unless proper erosion and sediment control measures and proper stabilization is provided.
- No fill may be placed adjacent to creek channel banks where it can cause bank failure, reduce stream flow capacity, or wash into creeks unless proper erosion and sediment control measures and proper stabilization is provided.
- Brush cleared from the site can be used as a temporary downgradient sediment barrier if placed on the contour to intercept and detain muddy runoff.
- Stabilized construction entrances must be located and used at all points of ingress/egress on a construction site. The transfer of soil, mud and dust onto public rights-of-ways must be prevented.
- Whenever construction dewatering operations are required on a site, they must be conducted according to the specifications set forth in this manual and according to KPDES requirements if discharging to a ditch or waterbody.
- Crossings of waterways during construction must be minimized and covered under the appropriate USACE section 404 permit. Encroachment into stream buffers, riparian areas, and wetlands must be avoided.
- Topsoil must be stockpiled and preserved from erosion or dispersal both during and after site grading operations.
- Cut and fill slopes should be seeded and mulched (or covered with blankets/mats) immediately after construction (i.e., within 14 days).
- Where construction or land disturbance activity will or has temporarily ceased on any portion of a site, temporary site stabilization measures must be required as soon as practicable, but no later than 14 calendar days after the activity has ceased.
- Final stabilization of the site must be required within 14 calendar days of construction completion.

The following sensitive features should be noted on site maps and plans:

- *Local Regulatory Floodplain and Conveyance Zone, as defined by local ordinances (see local planning and zoning or public works office).*
- *Stream and river corridors (including blue line and intermittent), as mapped by United States Geological Survey on 7.5 minute topographic maps.*
- *Karst features with a well-defined surface opening, such as a cave, sinkhole, vadose shaft, or other karst feature.*
- *Lakes and impoundments and their dams and spillways.*
- *Jurisdictional wetlands as determined by the USACE or that meet USACE designation criteria.*
- *Slopes greater than 25% (4H:1V).*
- *Erodible and severely erodible soils, as determined by the Natural Resources Conservation Service.*
- *Sites with the potential to drain stormwater directly into a sensitive feature listed above (including any designated buffer area for that feature) or into a designated greenway.*

Inspection and Maintenance

- Inspect ditches and other areas where runoff exits the site for rutting or evidence of muddy flows. Install BMPs (e.g., silt traps, sediment barriers) as needed.
- Inspect perimeter controls where sheet runoff exits the site for silt fence undercutting, bypassing, or damage. Repair existing controls or install new ones as needed.
- Inspect sediment traps and basins and other drainage system controls weekly and after rainfall of one-half inch or more to verify available sediment storage capacity.
- Inspect construction exit to ensure that no mud tracking onto the paved road is occurring.
- Check flagged areas to ensure that no damage or other impacts are occurring in stream buffers or other protected areas.
- Inspect cleared and excavated areas continuously to check for the presence of underground pipelines, tanks, sinkholes, or other unforeseen features.



Install silt fencing, sediment traps, and stabilize ditches before clearing and grading. Make sure stakes are on the downhill side of the silt fence!



Flag off and preserve vegetated areas along streams, wetlands, lakes, and ponds wherever possible. Keeping these areas intact minimizes the expenses involved in CWA section 404 permitting and extensive erosion and sediment controls. Riparian zone vegetation provides an excellent buffer against sediment carried by sheet runoff.

4.3.2 Construction Exit

Definition



Stabilized construction exits are installed before clearing and grading work begins, and maintained until the site is stabilized. Inspections should note whether mud is being tracked onto paved roads. Truck shaker racks or tire spray wash units can also be used to control off-side sediment tracking.

A construction exit is a stabilized pad of 2-inch or larger rock at any point where vehicles or equipment leave a construction site and enter a public right-of-way, street, alley, sidewalk, or parking area.

Purpose

A stabilized construction exit is intended to reduce off-site sedimentation and improve public safety by eliminating the tracking or other movement of sediment onto public rights-of-way.

Design Criteria

Construction plans must limit traffic exiting the site to properly constructed and stabilized construction exits.

- The entrance must be constructed at a location that minimizes the impact to streams and storm drains and maximizes public safety.
- The aggregate size for construction of the pad must be 2–3 inch stone, at a minimum (KYTC No. 1 or No. 2, not 57s or DGA).
- The thickness of the pad must not be less than 6 inches. Use geotextile fabrics below the rock, if necessary, to improve stability of the foundation in locations subject to seepage or high water table.
- The width of the pad must not be less than the full width of all points of ingress or egress and, in any case, must not be less than 12 feet wide. Allow for necessary turning radii for trucks and equipment. The length of the pad must be as required, but not less than 50 feet.

Construction Specifications

- Construct rock construction exit before clearing, grubbing, and grading the site. Place the gravel to the specific grade and dimensions shown on the plans, and level it out. A geotextile underliner helps to keep rock up out of the mud and functioning properly to remove mud from vehicle and equipment tires.
- Construction entrances will be located as shown on the development plans, or as directed by approving regulatory agency. Any deviation from this location must receive regulatory agency approval.
- Provide drainage to direct muddy runoff from the construction exit toward a sediment trap or other controlled area. In no case should muddy runoff from the construction exit flow onto roads, parking lots, surface waters, or adjacent properties.



- When necessary, wheels must be cleaned with a shovel, scraper, or high-pressure water hose to remove sediment before entrance onto roads or other paved areas. When washing is required, it must be done on an area stabilized with KYTC No. 1 or No. 2 rock that drains into an approved sediment trap or sediment basin.

Inspection and Maintenance

Inspect all construction exits twice a day during dry weather and more often during wet weather. Encourage equipment operators and other personnel to immediately report any mud tracking onto paved off-site areas.

- All sediment spilled, dropped, washed or tracked onto public rights-of-way must be removed immediately.
- The entrance must be maintained in a condition that will prevent tracking or flowing of sediment onto public rights-of-way. This could require periodic top dressing with additional stone as conditions demand, and repair or maintenance of any measures used to trap sediment.
- Replace gravel material when surface voids are filled with soil, or use a grubbing rake mounted to a front-end loader to stir the rock during dry conditions and shake down fine soil particles.
- Sediment from construction entrances and exits must be prevented from entering any storm drain, ditch, or watercourse through use of sediment traps, sand bags, commercial sediment dikes, inlet filters, or other approved methods. Maintain traps or other sediment trapping structures as needed.



A well-maintained construction exit keeps mud off the pavement and helps to reduce potential legal liability.

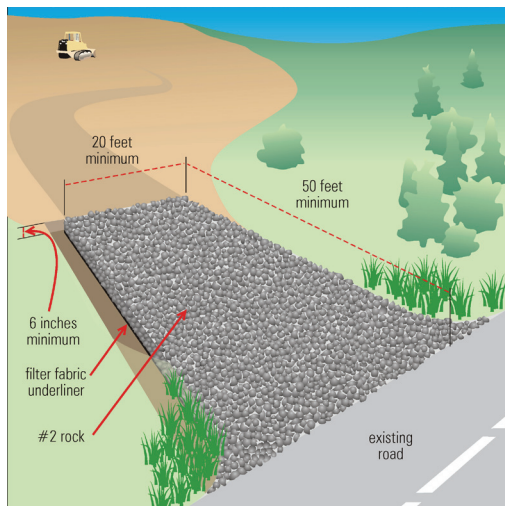

Dimensions are approximate; exits might need to be wider or longer to keep mud off paved public roads.



The construction exit will be one of the first things an inspector sees at the construction site and is often a good indication of how other controls are installed and maintained.

DIVERSION RIDGE REQUIRED
WHERE GRADE EXCEEDS 2%

2% OR GREATER



SECTION A - A

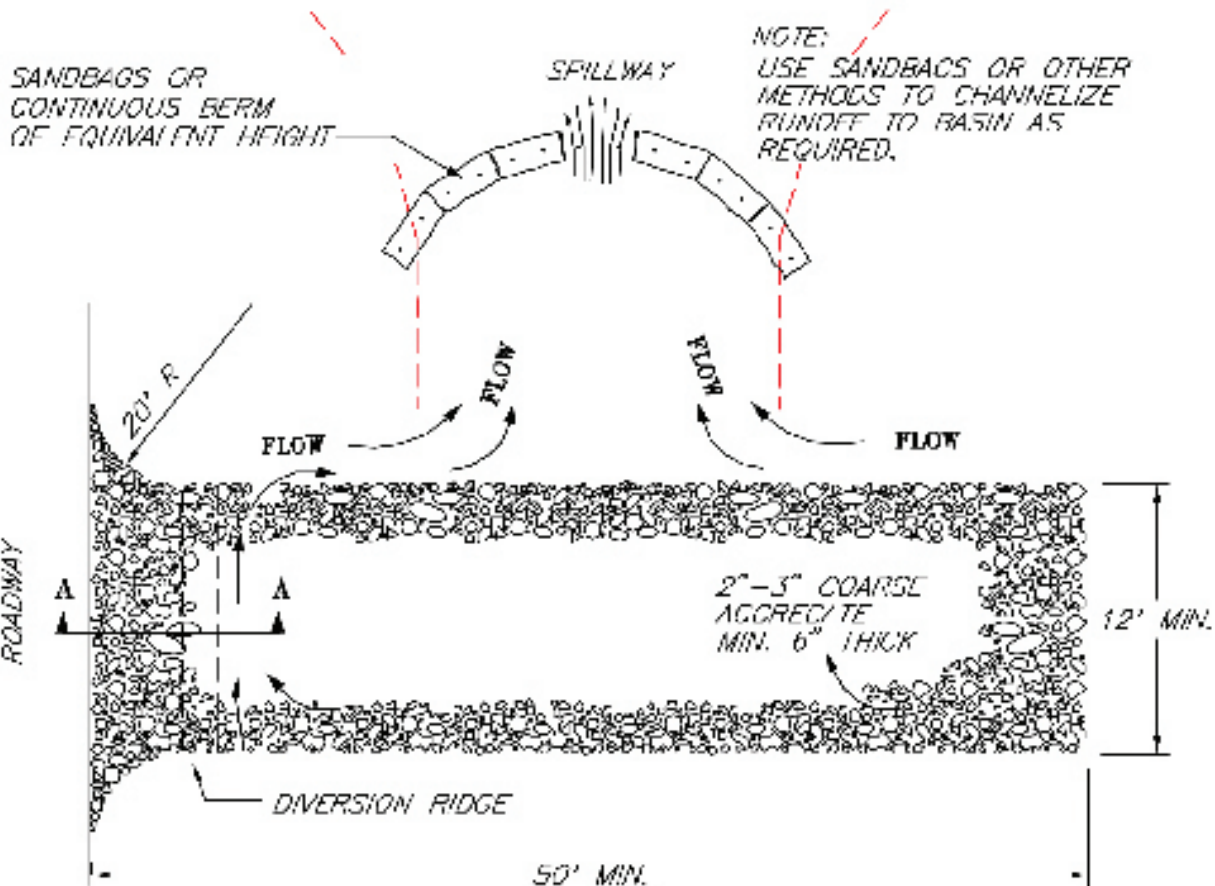

PLAN

NOTES:

1. THE ENTRANCE SHALL BE MAINTAINED IN A CONDITION THAT WILL PREVENT TRACKING OR FLOWING OF SEDIMENT ONTO PUBLIC RIGHT-OF-WAYS. THIS MAY REQUIRE TOP DRESSING, REPAIR AND/OR CLEAN OUT OF ANY MEASURES USED TO TRAP SEDIMENT.
2. WHEN NECESSARY, WHEELS SHALL BE CLEANED PRIOR TO ENTRANCE ONTO PUBLIC RIGHT-OF-WAY.
3. WHEN WASHING IS REQUIRED, IT SHALL BE DONE ON AN AREA STABILIZED WITH CRUSHED STONE THAT DRAINS INTO AN APPROVED SEDIMENT TRAP OR SEDIMENT BASIN.

SOURCE: SALIX APPLIED EARTH CARE -
EROSION DRAW 5.0

**CONSTRUCTION
ENTRANCE**

4.3 Site Preparation

4.3.3 Temporary Diversion (Berm or Ditch)



Use berms, ditches, fiber rolls, or other diversions to direct upslope water away from the disturbed area. This helps to reduce the amount of muddy runoff that controls must handle.

TD → TD →



Definition

A temporary berm, ditch, or channel constructed above an area of exposed soil.

Purpose

Temporary diversion is intended to divert clean upland runoff or drainage water away from unprotected disturbed areas and toward a vegetated infiltration area, stabilized ditch, or other stabilized outlet.

Design Criteria

Locate diversion berms and ditches to intercept and carry runoff around or through bare soil areas as needed. Berms should be located to minimize damage by construction operations and traffic.

- Berms and ditches should be designed to carry the 10-year, 24-hour peak flow.
- Side slopes should be 2H:1V or flatter.
- Freeboard should be at least 0.5 feet.
- Berms and ditches should be stabilized with triple-seeded grass (see seeding rates in Section 4.4.1) and mulch or an erosion control blanket, turf reinforcement mat, or rock. For information on stabilizing ditches of varying slopes, see Sections 4.6.5–4.6.7.

Construction Specifications

Temporary diversion berms or ditches must be installed as a first step in the land-disturbing activity and must be functional before downslope land disturbance.

- The berm must be adequately compacted to prevent failure.
- Temporary or permanent seeding and mulch must be applied to the berm or ditch immediately following its construction. Triple-seed areas below the flow line, and use erosion control blankets or turf reinforcement mats as needed.

Inspection and Maintenance

Inspect berms and ditches weekly and after every rainfall greater than one-half inch and after any repairs are made to the berm or flow channel. Check to make sure that berm or ditch is stable and outlet or infiltration areas are not eroding.

- If vegetation has not been established, reseed damaged and sparse areas immediately. Triple seed (see seeding rates in Section 4.4.1) areas below the flow line, and use erosion control blankets or turf reinforcement mats as necessary.
- Damages caused by construction traffic or other activity must be repaired before the end of each working day.

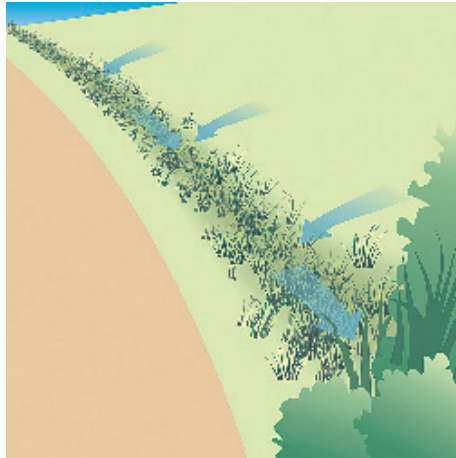

Stabilize diversion ditches by triple-seeding and mulching. Use nets or blankets if slopes are long (> 50 ft) and exceed 2 percent.

Diversion berms can be temporary or permanent. Make sure they are seeded and mulched immediately after construction. The upslope swale alongside steep berms might need an erosion control blanket to prevent scouring (for drainage system controls, see Section 4.6).



Stable diversion ditch protects slope during excavation and afterwards. Note spreader configuration of ditch discharge point, which helps dissipate flows.

Diversion berm directing runoff toward sediment trap: Controlling sheet runoff with berms and ditches ensures that flows are managed appropriately and provides the framework for a system of sediment traps and basins on larger sites.



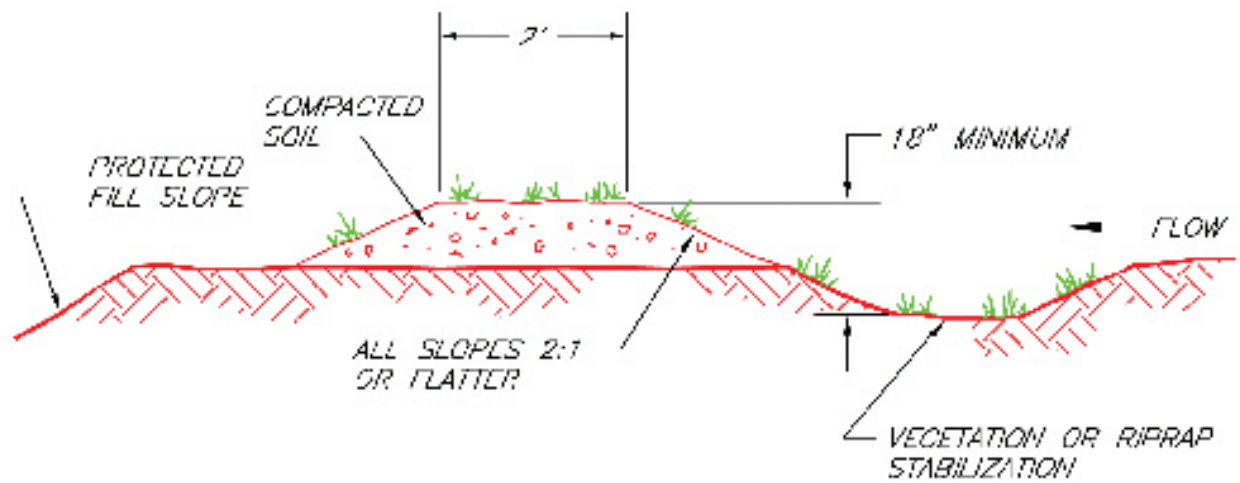

TYPICAL FILL DIVERSION

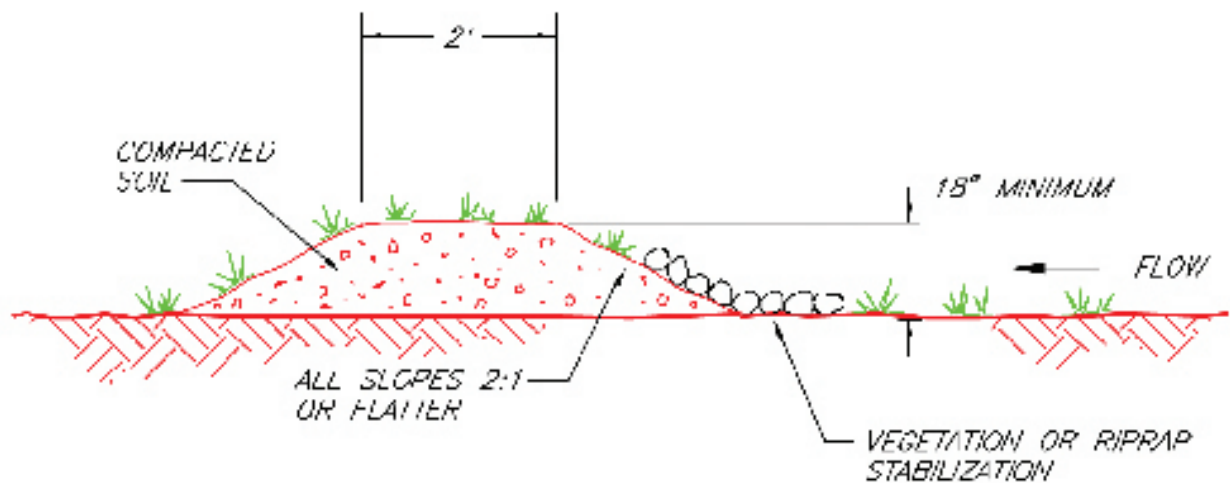

TYPICAL TEMPORARY DIVERSION DIKE

NOTES:

1. THE CHANNEL BEHIND THE DIKE SHALL HAVE POSITIVE GRADE TO A STABILIZED OUTLET.
2. THE DIKE SHALL BE ADEQUATELY COMPACTED TO PREVENT FAILURE.
3. THE DIKE SHALL BE STABILIZED WITH TEMPORARY OR PERMANENT SEEDING OR RIPRAP.

SOURCE: SALIX APPLIED EARTHCARE –
EROSION DRAW 5.0

**DIVERSION
CHANNEL**

4.3 Site Preparation

4.3.4 Topsoil Stockpiling



Stockpiles of soil can deliver large amounts of muddy runoff to paved roads, adjacent lawns, and local creeks. Plans should specify that soil should be stored on flat areas, seeded, and surrounded with silt fencing to control offsite sediment impacts.



Definition

Stockpiling is the salvaging, storing, protecting, and use of topsoil to enhance final site stabilization and support selected vegetation.

Purpose

The purpose of topsoil stockpiling is to provide a suitable growth medium for vegetation. It should be used where the subsoil or areas of existing surface soil present the following problems:

- The structure, pH, or nutrient balance of the available soil cannot be amended by reasonable means to provide an adequate growth medium for the desired vegetation.
- The soil is too shallow to provide adequate rooting depth or will not supply necessary moisture and nutrients for growth of desired vegetation.
- The soil contains substances toxic to the desired vegetation.
- Stockpiling should also be used where high-quality turf or ornamental plants are desired and where slopes are 2H:1V or flatter.

Topsoil is the surface layer of the soil profile, generally characterized as darker than the subsoil because of enrichment with organic matter. It is the major zone of root development and biological activity—microorganisms that enhance plant growth thrive in this layer. Topsoil can usually be differentiated from subsoil by texture as well as color. Clay content usually increases in the subsoil. Where subsoils are often high in clay, the topsoil layer can be significantly coarser in texture. The depth of topsoil can be quite variable. On severely eroded sites, it might be gone entirely.

Advantages of topsoil over subsoil include its high organic-matter content and friable consistence (soil aggregates can be crushed with only moderate pressure) and its available water-holding capacity and nutrient content. The texture and friability of topsoil provide benefits to seedlings the growth of their roots. In addition to being a better growth medium, topsoils are often less erodible than subsoils, and the coarser texture of topsoil increases infiltration capacity and reduces runoff.

Although topsoil can provide an improved growth medium, there could be disadvantages, too. Stripping, stockpiling, hauling, and spreading topsoil or importing topsoil might not be cost effective. Handling can be difficult if large amounts of branches or rocks are present, or if the terrain is rough. Most topsoil contains weed seeds that compete with desirable species.

In site planning, compare the options of stockpiling with preparing a seedbed in the available subsoil.

The clay content of many subsoils retains moisture. When properly limed and fertilized, subsoils can provide a satisfactory growth medium that is generally free of weed seeds. Stockpiling is normally recommended where ornamental plants or high-maintenance turf will be grown. It might also be required to establish vegetation on shallow soils, soils containing potentially toxic materials, stony soils, and soils of critically low pH (high acidity).

Design Criteria

If topsoil is to be stockpiled, consider the following:

- Quality and amount of topsoil available and needed.
- Location for a stabilized stockpile that will not erode, block drainage, or interfere with work on the site. Topsoil stockpiles should be on flat ground if possible, and protected by a silt fence or other sediment barrier on the downgradient sides. Topsoil that will not be used for more than 14 days must be mulched or seeded.
- If topsoil and subsoil are not properly bonded, water will not infiltrate the soil profile evenly, and it will be difficult to establish vegetation. To promote bonding, scarify or rip subsoil to a depth of 8–12 inches; do not compact during topsoil placement operations.
- Do not apply topsoil to slopes steeper than 2:1 to avoid slippage, or to a subsoil of highly contrasting texture. Sandy topsoil over clay subsoil is a particularly poor combination, especially on steep slopes. Water can creep along the junction between the soil layers and cause the topsoil layer to slip or slough.

Cubic Yards of Topsoil Required to Attain Various Soil Depths

| Depth (Inches) | Per 1,000 Square Feet | Per Acre |
|----------------|-----------------------|----------|
| 1 | 3.1 | 134 |
| 2 | 6.2 | 268 |
| 3 | 9.3 | 403 |
| 4 | 12.4 | 537 |
| 5 | 15.5 | 672 |
| 6 | 18.6 | 806 |

Construction Specifications

Materials

Quality topsoil has the following characteristics:

The best texture is loam, sandy loam, and silt loam. Sandy clay loam, silty clay loam, clay loam, and loamy sand are fair. Do not use heavy clay and highly organic soils such as peat or muck as topsoil.

Organic matter content should be greater than 1 percent by weight.

Liming is required if pH is less than 6.0.

The depth of material meeting the above qualifications should be at least 2 inches. Soil factors such as rock fragments, slope, depth to water table, and layer thickness affect the ease of excavation and spreading of topsoil.

Generally, the upper part of the soil that is richest in organic matter is most desirable; however, material excavated from deeper layers could be worth storing if it meets the other criteria listed above.

Organic soils such as mucks and peats do not make good topsoil. They can be identified by their extremely light weight when dry.

Stripping

Strip topsoil from only those areas that will be disturbed by excavation, filling, road building, or compaction by equipment. **Avoid stripping topsoil to the extent that stormwater infiltration is significantly reduced.** A 4–6 inch stripping depth is common but depth varies depending on the site. Determine depth of stripping by taking soil cores at several locations within each area to be stripped. Topsoil depth generally varies along a gradient from hilltop to toe of slope. Put sediment basins, diversions, and other controls into place before stripping.

Stockpiling

Select stockpile location to avoid slopes, flood plains, natural channels, and traffic routes. Stockpiles should be placed away from water bodies to prevent sedimentation. On large sites, re-spreading is easier and more economical when topsoil is stockpiled in small piles near areas where they will be used.

Use silt fences or other barriers where necessary to retain sediment.

Protect topsoil stockpiles by temporarily seeding as soon as possible, and for no longer than 14 days if the stockpile is idle.

If stockpiles will not be used within 2 months, they must be stabilized with permanent vegetation to control erosion and weed growth.

Site Preparation

Before spreading topsoil, establish erosion and sedimentation control practices such as diversions, berms, and sediment basins.

Maintain grades on the areas to be topsoiled according to the approved plan. Adjust grades and elevations for receipt of topsoil.

Where the pH of the existing subsoil is 6.0 or less, or the soil is composed of heavy clays, incorporate agricultural limestone in amounts recommended by soil tests or specified for the seeding mixture to be used. Incorporate lime to a depth of at least 2 inches by disking.

Immediately before spreading the topsoil, loosen the subgrade by disking or scarifying to a depth of at least 4 inches to ensure bonding of the topsoil and subsoil. If no amendments have been incorporated, loosen the soil to a depth of at least 6 inches before spreading topsoil.

Spreading Topsoil

Uniformly distribute topsoil to a minimum compact depth of 2 inches on 3:1 slopes and 4 inches on flatter slopes. Do not spread topsoil while it is frozen or muddy or when the subgrade is wet or frozen.

Correct any irregularities in the surface that result from stockpiling or other operations to prevent the formation of depressions or water pockets.

Compact the topsoil enough to ensure good contact with the underlying soil, but avoid excessive compaction as it increases runoff and inhibits seed germination. Light packing with a roller is recommended where high-maintenance turf is to be established.

On slopes and areas that will not be mowed, the surface may be left rough after spreading topsoil. A disk may be used to promote bonding at the interface between the topsoil and subsoil.

After topsoil application, follow procedures for temporary or permanent seeding, taking care to avoid excessive mixing of topsoil into the subsoil.



This is a good location of topsoil pile on flat, grassy area and good use of a silt fence to protect nearby creek (foreground).

4.3 Site Preparation

4.3.5 Surface Roughening



Specify surface roughening for bare areas that will be prepared for seeding and sodding. Roughening improves soil-to-seed contact and reduces erosion on slopes.



Definition

Surface roughening is a technique for creating horizontal depressions, furrows, or other roughened surfaces on bare ground using tracked or other equipment.

Purpose

Surface roughening is intended to aid the establishment of vegetative cover from seed, reduce runoff velocity, increase infiltration, reduce erosion, and to provide for sediment trapping. All construction slopes require surface roughening to facilitate long-term stabilization with vegetation, particularly slopes that are steeper than 3H:1V.

Rough slope surfaces are preferred because they aid the establishment of vegetation, improve water infiltration, and decrease runoff velocity. Graded areas with smooth, hard surfaces can be initially attractive, but such surfaces increase the potential for erosion. A rough, loose soil surface is more favorable for rain infiltration and moisture retention than hard, smooth surfaces; this aids in seed germination.

Design Criteria

There are different methods for achieving a roughened soil surface on a slope, and the selection of an appropriate method depends upon the type of slope. Roughening methods include stair-step grading, furrowing, and tracking. Factors to consider in choosing a method are slope steepness, mowing requirements, and whether the slope is formed by cutting or filling.

Roughening techniques that call for indentations, furrows, ridges, stair-step grading (small benches), and so forth (see table) should specify that all these features be perpendicular to the direction of flow (i.e., across the slope rather than up and down). Surface roughening should be specified for all slopes at final grade and those not being actively worked as detailed below in the Construction Specifications section.

Soil Conditions vs. Erosion

| If soil is: | Erosion will be: |
|---------------------------|------------------------|
| Compacted and smooth | 30 percent <i>more</i> |
| Tracks across slopes | 20 percent <i>more</i> |
| Tracks up & down slopes | 10 percent <i>less</i> |
| Rough and irregular | 10 percent <i>less</i> |
| Rough & loose to 12" deep | 20 percent <i>less</i> |

Construction Specifications

Cut Slope Roughening

- Stair-step grade or groove all cut slopes that are steeper than 3H:1V.
- Use stair-step grading on any erodible material soft enough to be ripped with a bulldozer. Slopes consisting of soft rock with some subsoil are particularly suited to stair-step grading.
- Make the vertical cut distance less than the horizontal distance, and slightly slope the horizontal position of the *step* in toward the vertical wall.
- Do not make individual vertical cuts more than 2 feet high in soft materials or more than 3 feet high in rocky materials.
- Groove the slope using machinery to create a series of ridges and depressions that run across the slope, on the contour.

Fill Slope Roughening

- Place fill slopes with a gradient steeper than 3H:1V in lifts not to exceed 8 inches, and make sure each lift is properly compacted.
- Ensure that the face of the slope consists of loose, uncompacted fill 4–6 inches deep.
- Use grooving or tracking to roughen the face of the slopes, if necessary. Grooves and track indentions must be perpendicular to the direction of downslope flow.
- Apply seed, fertilizer, and straw mulch then track or punch in the mulch with the bulldozer.
- Do not blade or scrape the final slope face.

Cuts, Fills, and Graded Areas

- Make mowed slopes no steeper than 3H:1V.
- Roughen these areas to shallow grooves by normal tilling, disking, harrowing, or use a cultipacker-seeder. Make the final pass of any such tillage on the contour (i.e., across the slope rather than up and down).
- Make grooves formed by such implements close together (less than 10 inches, and not less than 1 inch deep).
- Excessive roughness is undesirable where mowing is planned.

Roughening With Tracked Machinery

- Limit roughening with tracked machinery to soils with a sandy textural component to avoid undue compaction of the soil surface. Tracking soils with heavy clay content can cause compaction and *seal* the slope soils, increasing runoff and making seed germination difficult.
- Operate tracked machinery up and down the slope to leave horizontal depressions in the soil. Do not back-blade during the final grading operation.
- Immediately seed and mulch roughened areas to obtain optimum seed germination and growth. Use erosion control blankets or turf reinforcement mats on long (> 50 feet) steep (> 2H:1V) slopes as necessary, or hydroseed.

Inspection and Maintenance

Periodically check the seeded slopes for rills and washes. Fill these areas slightly above the original grade, then reseed and mulch or cover with blanket or mat as soon as possible.

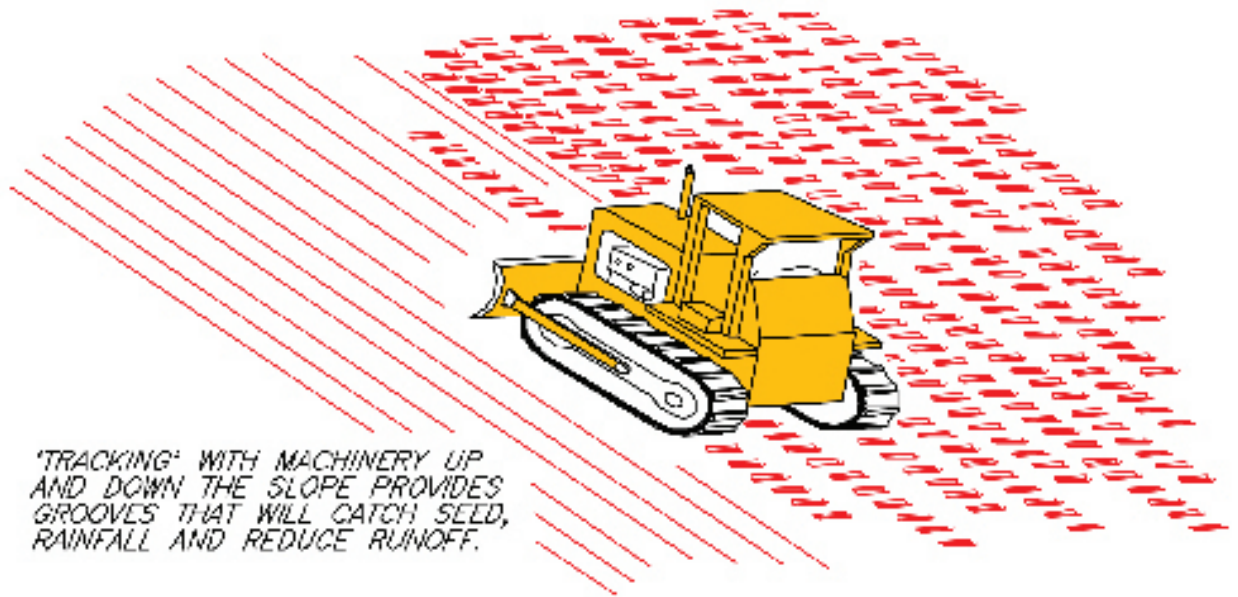

TRACKING

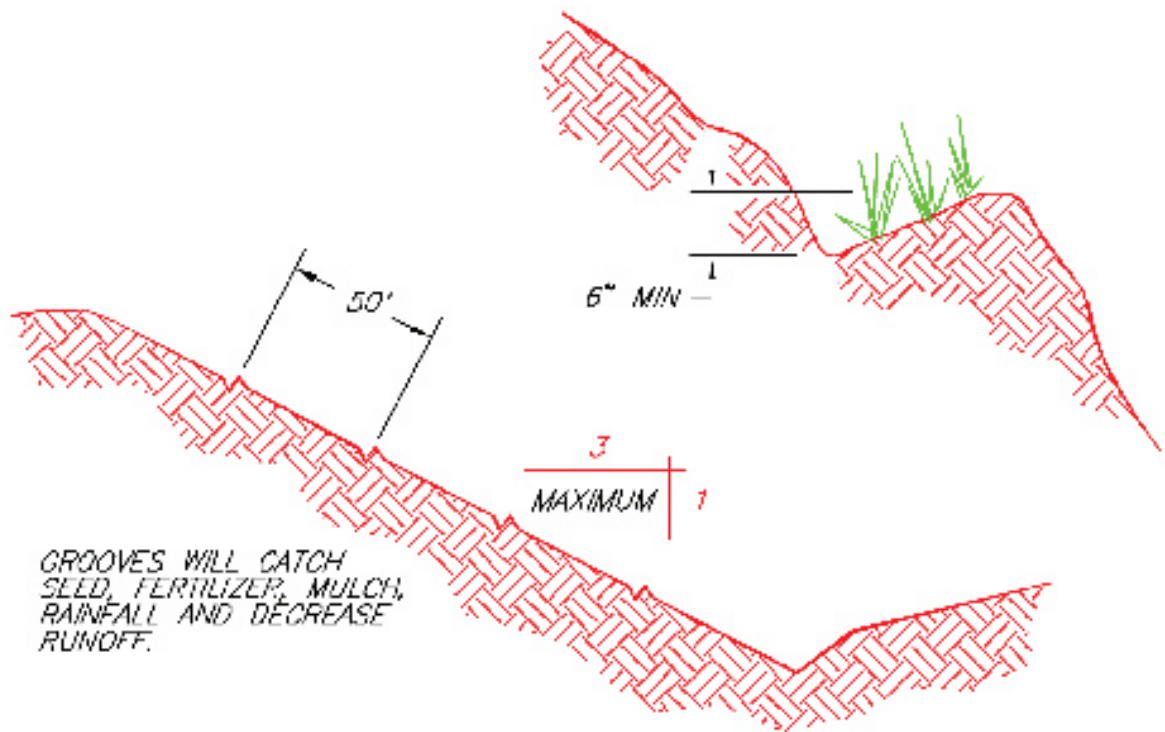

CONTOUR FURROWS

SURFACE ROUGHENING

4.4 Soil Stabilization

General Information

A variety of soil stabilization BMPs are available. All practices discussed in this section seek to vegetate or otherwise cover bare soil areas with grass, mulch, sod, or other material for the purpose of reducing raindrop erosion, muddy runoff, gullying, and dust problems. Note that for all sites with a disturbed area of one acre or more, **Kentucky requires that bare areas that have not been actively worked for 14 consecutive days be temporarily or permanently stabilized.** In practice, this means that seed, mulch, or other cover must be in place after 14 days if no clearing or grading has occurred in an area. Also, note that the use of erosion control blankets and turf reinforcement mats—which are specified for some bare areas, slopes, and ditches—are discussed in the Slope Protection section.

Hydraulically Applied Products

Note that hydraulically applied (i.e., spray-on) seed and mulch products have undergone rapid development and improvement during the past 10 years and now provide seed establishment and soil protection performance equivalent (or superior) to conventional seeding and mulching practices. The key benefits of hydraulically applied products are realized on large sites with steep (3H:1V to 1H:1V), long slopes or other areas where installation of erosion control blankets or turf reinforcement mats is difficult. A nearby source of water—or water tank—to mix the slurry is also necessary for large sites.

Typical hydraulic soil cover applications include a slurry-like mix of seed, fertilizer, and mulch. Also available for inclusion are other amendments such as tackifier and a variety of fibrous materials that dry to form a flexible *net* or crust that provides excellent protection for bare soil before seed germination.

Application equipment ranges from small, hand-pulled polyethylene units with electric sprayers and tanks that hold up to 15 pounds of seed, fertilizer, and mulch to large, towed or truck-mounted machines with tanks of 100–2,000 gallons. Mixing ratios will vary significantly by application, but in general a standard turf application for one acre will include 100–150 pounds of seed (or more, depending on seed variety and site conditions), 300–400 pounds of fertilizer, 140 pounds of binder, and 1,500–2,000 pounds of fiber mulch mixed with 4,000 or more gallons of water.



Soils on flatter areas are stabilized by temporary/permanent seeding and mulching. On slopes, tracking with a bulldozer or other equipment creates indentations perpendicular to runoff flow that effectively increase overall slope length and trap seed and sediment. Long, steep slopes typically require erosion control blankets or turf reinforcement mats (see Slope Protection section). Another key planning consideration for slopes is how to get upslope drainage down to the bottom, which is also covered in the Slope Protection section.

4.4 Soil Stabilization

4.4.1 Temporary Seeding



Temporary seeding and/or mulching is necessary for bare areas that have not been worked for 14 or more consecutive days, according to state and local regulations.



Definition

Temporary seeding uses rapidly growing grass to stabilize disturbed areas that have not reached final grade. Areas that will be inactive for 14 days or more must be seeded and mulched.

Purpose

Temporary seeding serves to reduce problems associated with muddy runoff or dust from bare soil surfaces during construction and to maintain sheet flow, protect the soil surface, and promote infiltration into the soil; to protect the soil and prepare it for permanent seeding at a later date; and to reduce aesthetic and other concerns regarding water quality and visual impacts associated with construction areas.

Design Criteria

The area must be protected from excess run-on from upgradient areas as necessary with diversions or berms. Plant species must be selected on the basis of quick germination, growth, and time of year to be seeded. Fertilizer, lime, seedbed preparation, seed coverage, mulch, and irrigation must be used as necessary to promote quick plant growth.

Mulch should be specified for sites with slopes greater than five percent (20H:1V) and slope lengths greater than 100 feet.

Construction Specifications

Site Preparation

Grade as needed and feasible to permit the use of conventional equipment for seedbed preparation, seeding, mulch application, and anchoring.

Install the needed erosion control practices before seeding such as diversions ditches and berms.

Do not apply fertilizer, lime, or seed before heavy rain storms (e.g., predicted to be one-half inch or more in one hour or less).

Seedbed Preparation

Mix seed, mulch, and other material for application via hydraulic spray equipment or follow the procedure below.

Spread lime (in lieu of a soil test recommendation) on acid soil (pH 5.5 or lower) and subsoil at a rate of one ton per acre of agricultural ground limestone. For best results, test soil pH and fertility—this can

reduce the expense of unneeded lime and fertilizer and potential excess nutrient loss through runoff and leaching.

Fertilizer (in lieu of a soil test recommendation) must be applied at a rate of no more than 800 pounds per acre of 10-10-10 analysis or equivalent.

Work the lime and fertilizer into the soil with a disk harrow, springtooth harrow, or similar tools to a depth of two inches. On sloping areas, the final operation must be on the contour.

Seeding Rates for Temporary Site Protection

| March 1 to October 31 | Per 1,000 Square Feet | Per Acre |
|---------------------------|-----------------------|----------|
| 1. Oats | 3 lbs. | 120 lbs. |
| 2. Perennial Ryegrass | 1 lbs. | 40 lbs. |
| 3. Tall Fescue | 1 lbs. | 40 lbs. |
| 4. Wheat | 3 lbs. | 120 lbs. |
| 5. Annual Rye | 3 lbs. | 120 lbs. |
| November 1 to February 28 | Per 1,000 Square Feet | Per Acre |
| 1. Annual Rye | 3 lbs. | 120 lbs. |
| 2. Wheat | 3 lbs. | 120 lbs. |
| 3. Perennial Ryegrass | 1 lb. | 40 lbs. |
| 4. Tall Fescue | 3 lbs. | 120 lbs. |

Apply the seed uniformly with a cyclone seeder, drill, or hydroseeder (slurry can include seed and fertilizer) preferably on a firm, moist seedbed. Seed no deeper than one-fourth inch to one-half inch.

When feasible, except where a cyclone type seeder is used, the seedbed should be firmed following seeding operations with a cyclone, roller, or light drag. On sloping land, seeding operations should be on the contour wherever possible.

Triple the seeding rate for all ditches that will carry flowing water; cover seed with erosion control blanket or turf reinforcement mat if needed to prevent ditch erosion.

Inspection and Maintenance

Water the soil until the grass is firmly established. This is especially needed when seedings are made late in the planting season, in abnormally dry and hot seasons, or on sites with steep slopes or other adverse conditions.

Prepare spot repairs by working soil where seed establishment is poor, applying additional seed, and covering with mulch or erosion control blanket. Water area during dry conditions.



Designate haul roads and material storage areas on large sites, and seed or mulch the rest to minimize the amount of bare areas exposed to the weather. KPDES regulations require that portions of the site that have not been worked for 14 consecutive days be temporarily or permanently stabilized with seed and/or mulch.

4.4 Soil Stabilization

4.4.2 Permanent Seeding



Establishing grass through broadcast or hydro-seeding reduces erosion and sediment loss by more than 90 percent. Use mulch on short flatter slopes and erosion control blankets or hydro-mulch on long steep slopes.



Definition

Permanent seeding is the establishment of permanent, perennial vegetative cover—usually grass—on disturbed areas. Permanent seeding must be applied to disturbed areas within 14 days of reaching final grade if no temporary cover is applied.

Purpose

Permanent seeding is intended to maintain sheet flow, promote infiltration, and reduce problems associated with muddy runoff or dust from bare soil surfaces during construction; to reduce sediment runoff to downstream areas and improve the visual aesthetics of the construction area; and to provide permanent site stabilization in preparation for completion of the project.

Design Criteria

The area must be protected from excess runoff as necessary with upgradient diversion berms or ditches. Plant species must be selected on the basis of quick germination, growth, and time of year to be seeded. Fertilizer, lime, seedbed preparation, seed coverage, mulch, and irrigation must be applied as necessary to promote quick plant growth.

Construction Specifications

Site Preparation

Soil should be capable of supporting permanent vegetation and have at least 25 percent silt and clay to provide an adequate amount of moisture holding capacity. An excessive amount of porous sand will not consistently provide sufficient moisture for good growth regardless of other soil factors.

- Plan to seed all areas as soon as final grade is reached, to take advantage of soil seedbed conditions and to minimize erosion potential.
- Where compacted soils occur, they should be broken up sufficiently to create a favorable rooting depth of 6–8 inches.
- Stockpile topsoil to apply to sites that are otherwise unsuited for establishing vegetation. Approximately 400 cubic yards of topsoil per acre are needed for application depths of 3 inches (~9.3 cubic yards per 1,000 square feet).
- Grade as needed and feasible to permit the use of conventional equipment for seedbed preparation, seeding, mulch application and anchoring, and maintenance. After the grading operation, spread topsoil where needed.

- Install the needed erosion control practices, such as diversion berms and ditches.

Seedbed Preparation

Spread lime (in lieu of a soil test recommendation) on acid soil and subsoil, at a rate of one ton per acre of agricultural ground limestone. For best results, test the soil—this can reduce the expense of unneeded lime and fertilizer and potential excess nutrient loss through runoff and leaching.

Fertilizer (in lieu of a soil test recommendation) should be applied at a rate of no more than 800 pounds per acre of 10-10-10 analysis. For best results, test the soil to determine fertilizer requirements. In limestone areas with streams and rivers impacted by high algae concentrations, use 10-0-10 fertilizer.

Work the lime and fertilizer into the soil with a disk harrow, springtooth harrow, or other suitable field equipment to a depth of 4 inches. On sloping land, the final operation must be on the contour.

Kentucky Transportation Cabinet Seed Mixes

| Mixture Type | Seed Mixture |
|-----------------|---|
| Mixture No. I | 75% Kentucky 31 Tall Fescue 10% Red Top 5% White Dutch Clover 10% Ryegrass (perennial) |
| Mixture No. III | 30% Kentucky 31 Tall Fescue 15% Red Top 15% Partridge Pea 20% Sericea Lespedeza 10% Sweet Clover – Yellow 10% Ryegrass |

KYTC does not specify the seeding rate but requires that sufficient seed be applied to ensure a “dense, uniform vegetative cover.”

Recommended Seeding Rates and Other Information for Various Species and Seed Mixtures

| Seed species & mixtures | Seeding rate/acre | Per 1000 sq. ft | Soil pH | Other Information |
|---|--------------------------|------------------------|----------------|--|
| Seed and seed mixtures for relatively flat or slightly sloping areas | | | | |
| Perennial ryegrass | 25 to 35 lbs | 1 lb | 5.6 to 7.0 | Apply lime at 2 tons per acre if soil pH is below 5.5; use 400-800 lb fertilizer (10-10-10) on poor soils. Use wildflower mixes to save on mowing and watering costs. |
| + tall fescue | 15 to 30 lbs | 1 lb | 5.5 to 7.5 | |
| Tall fescue | 40 to 50 lbs | 1.5 lb | | |
| + ladino or white clover | 1 to 2 lbs | 2 oz | | |
| Steep slopes, banks, cuts, and other low maintenance areas (not mowed) | | | | |
| Smooth bromegrass | 25 to 35 lbs | 1 lb | 5.5 to 7.5 | Track steep slopes with dozer up and down hill before seeding. Mulch slopes after seeding with 2 to 3 tons of straw or 6 tons of wood chips per acre. Use tackifier on mulch, disk it in, or punch in with sheep-foot roller. Disk or sheep-foot on the contour (across slope, on the level). For extremely steep slopes, use erosion control blankets after seeding. Use 20" spacing on blanket staples |
| + red clover | 10 to 20 lbs | 0.5 lb | | |
| Tall fescue | 40 to 50 lbs | 1 lb | 5.5 to 7.5 | |
| + white or ladino clover | 1 to 2 lbs | 2 oz | | |
| Orchardgrass | 20 to 30 lbs | 1 lb | 5.6 to 7.0 | |
| + red clover | 10 to 20 lbs | 0.5 lb | | |
| + ladino clover | 1 to 2 lbs | 2 oz | | |
| Crownvetch | 10 to 12 lbs | 0.25 lb | 5.6 to 7.0 | |
| + tall fescue | 20 to 30 lbs | 1 lb | | |
| Seed species & mixtures | | | | |
| | Seeding rate/acre | Per 1000 sq. ft | Soil pH | Other Information |
| Lawns and other high traffic or high maintenance areas (mowed) | | | | |

| | | | | |
|---|----------------|--------|------------|--|
| Bluegrass | 105 to 140 lbs | 3 lb | 5.5 to 7.0 | Use wildflower mixes to save on mowing and watering costs. Do not establish grassed lawns near streams or wetlands—leave a 15 to 30 ft buffer of natural vegetation. |
| Perennial ryegrass (turf) | 45 to 60 lbs | 2 lb | 5.6 to 7.0 | |
| + bluegrass | 79 to 90 lbs | 2.5 lb | | |
| Tall fescue (turf type) | 130 to 170 lbs | 4 lb | 5.6 to 7.5 | |
| + bluegrass | 20 to 30 lbs | 1 lb | | |
| Channels and other areas of concentrated water flows | | | | |
| Perennial ryegrass | 100 to 150 lbs | 3 lb | 5.6 to 7.0 | Seed ditches and channels thickly. Do not use fertilizer near ditch or channel bottom. Use erosion control blankets or turf reinforcement mats when channel bottom slopes exceed 3%. |
| + white or ladino clover | 1 to 2 lbs | 2 oz | | |
| Kentucky bluegrass | 20 lbs | 0.5 lb | 5.5 to 7.5 | Silt check dams are needed when channel slopes exceed 5% or when channels begin downcutting (gulying) on the bottom. Do not use silt fencing or straw bales as silt check dams in channels with slopes greater than 3%; use rock or brush instead. |
| + smooth brome grass | 10 lbs | .25 lb | | |
| + switchgrass | 3 lbs | 2 oz | | |
| + timothy | 4 lbs | .25 lb | | |
| + perennial ryegrass | 10 lbs | .25 lb | | |
| + white or ladino clover | 1 to 2 lbs | 2 oz | | |
| Tall fescue | 100 to 150 lbs | 3 lb | 5.5 to 7.5 | |
| + ladino or white clover | 1 to 2 lbs | 2 oz | | |
| Tall fescue | 100 to 150 lbs | 3 lb | 5.5 to 7.5 | |
| + perennial ryegrass | 15 to 20 lbs | 0.5 lb | | |
| + Kentucky bluegrass | 15 to 20 lbs | 0.5 lb | | |

Inspection and Maintenance

Water the soil until the grass is firmly established. This is especially needed when seedings are made late in the planting season, in abnormally dry and hot season, or on sites with steep slopes or other adverse conditions.

Inspect all seeded areas for failures and make necessary repairs, replacements, reseeding, and mulching within the planting season.

If stand is inadequate, (less than 85 percent groundcover) seed over the site and fertilize, using half of the seeding rate originally applied, and apply mulch.

If stand is more than 60 percent damaged, reestablish the stand. Follow the original seedbed preparation methods, seeding and mulching recommendations, and apply lime and fertilizer as needed according to a soil test.



Seed ditches immediately after construction. Use mulch, netting, or erosion control blankets to protect newly seeded areas.

Hydraulically applied seed, mulch, tackifier, and soil amendments (e.g., lime, fertilizer) offer excellent results at a reasonable price on large sites, especially those with long, steep slopes. Follow manufacturer's recommendation regarding materials mixing and application rates.



4.4 Soil Stabilization

4.4.3 Mulching



Mulch can be hand-scattered or blown straw or other material used on temporary or final grades. Use chemical tackifiers, netting, or blankets if wind is a concern. Mulch alone can reduce erosive forces by more than 90 percent; with seeding, the reductions approach 99 percent.



Definition

Mulching is the application of a protective layer of straw, cellulose, or other suitable material to the soil surface. Straw mulch and/or hydromulch are also used in conjunction with seeding and hydroseeding of critical areas for the establishment of temporary or permanent vegetation.

Purpose

Mulching serves to temporarily stabilize seeded or unseeded bare soil areas, to protect the soil surface from raindrop impact, to increase infiltration, to conserve moisture, to prevent soil compaction or crusting, and to decrease runoff. Mulching also fosters growth of vegetation by protecting the seeds from predators, reducing evaporation, and insulating the soil. Mulching with straw or fiber mulches is commonly used as a temporary measure to protect bare or disturbed soil areas that have not been seeded.

Design Criteria

Mulch can be applied to any site where soil has been disturbed and the protective vegetation has been removed. The most common use of a mulch is to provide temporary stabilization of soil, usually until permanent stabilizing vegetation is established. Where mulches are used to complement vegetation establishment, they should be designed to last as long as it takes to establish effective vegetative erosion control.

Where mulches are used as surface cover only (i.e. bark, wood chips, or straw mulch cover) the serviceable duration of the application and maintenance requirements, including augmentation or replication should be specified.

On steep slopes, greater than 2.5H:1V, or where the mulch is susceptible to movement by wind or water, the mulch material should be hydraulically applied or the straw mulch should be appropriately anchored. Hydraulic fiber mulches or tackifying agents are used effectively to bind the straw together and prevent displacement by wind or rain. Straw can also be covered by degradable netting or secured by crimping (see below).

NOTE: For steep slopes—especially long ones—specify erosion control blankets (see Section 3) or hydraulically applied mulches with sufficient tackifier to protect seedbed. Nets can be used with straw mulch if properly staked down.

Summary of Mulch Design and Application Considerations

| Mulch product | Application rate | Benefits | Limitations |
|------------------------------------|----------------------------------|---|--|
| Straw or hay | 1½ to 2½ tons per acre | Readily available and inexpensive; very effective in controlling erosion; can be applied on large sites via blower | Can carry unwanted seeds; might need tackifier or anchoring, especially on steep slopes |
| Wood chips, bark, sawdust | 5 to 8 tons per acre | Very low cost in some locations; chips effective on slopes up to 35% | High nitrogen demand when decomposing; can float away or blow away during rain storms |
| Rock | 200 to 500 tons or more per acre | Could be inexpensive and readily available in some localities; might be suitable for smaller sites | Inhibits plant growth; adds no nutrients to the soil; can be costly to apply on slopes and large sites; adds "hardened" look to slopes |
| Hydraulic mulches and soil binders | 1½ to 2 tons per acre | Easily and rapidly applied with sprayer equipment; can include seed, fertilizer, flexible/fibrous mulches, and soil binders | Could be too expensive for small or very remote sites; must dry for at least 24 hours before rainfall |

Construction Specifications

Straw

Straw is an excellent mulch material. Because of its length and bulk, it is highly effective in reducing the impact of raindrops and in moderating the microclimate of the soil surface. Straw mulch can be applied by hand on small sites and blown on by machine on large sites. Straw blowers have a range of about 50 feet. Some commercial models advertise a range up to 85 feet and a capacity of 15 tons per hour.

- Mulch should not be applied more than 2 inches deep on seeded sites, unless it is incorporated into the soil by tracking, disking (crimping), or other *punching in* techniques. If the straw is applied at rates higher than 3 tons per acre, the mulch could be too dense for the sunlight and seedlings to penetrate.
- Before mulching, install any needed erosion and sediment control practices such as diversions, grade stabilization structures, berms, dikes, grass-lined channels and sediment basins.
- Obtain clean wheat, barley, oat, or rice straw to prevent the spread of noxious weeds. Avoid moldy, compacted straw because it tends to clump and is not distributed evenly.
- The straw must be evenly distributed by hand or machine to the desired depth (about 2 inches) and should cover the exposed area to a uniform depth. One bale (approximately 80 lbs) of straw covers about 1000 square feet adequately. The soil surface should be barely visible through the straw mulch. On steep or high-wind sites, straw must be anchored to keep it from blowing away.
- For seeded sites, apply 1.5–2 tons per acre, 1–2 inches deep, covering 80 percent of the soil surface. For unseeded sites, use 1.5–2.5 tons per acre, apply 2–4 inches deep, covering 90 percent of the soil surface.
- Mulch must be anchored immediately to minimize loss by wind or water. Straw mulch is commonly anchored by crimping, tracking, disking, or punching into the soil; covering with a netting material; spraying with asphaltic or organic tackifier; or tacking with cellulose fiber mulch at a rate of 750 pounds per acre.
- On small sites where straw has been distributed by hand, it can be anchored by hand punching it into the soil every 1–2 feet with a dull, round-nosed shovel. A sharp shovel will merely cut the straw and not anchor it. A mulch anchoring tool is a tractor-drawn implement designed to punch and anchor mulch into the top 2–8 inches of soil. This practice affords maximum erosion control but is limited to flatter slopes where equipment can operate safely. A set of disk harrows can be used for this purpose if the disks are straightened (not angled) so they cut the straw into the soil. Tracking is the process of cutting straw into the soil using a bulldozer or other equipment

that runs on cleated tracks. Tracking is used primarily on slopes 3:1 or flatter where this type of equipment can safely operate. This is an effective way to crimp straw on fill slopes. Tracking equipment must operate up and down the slope so the cleat tracks are perpendicular to flow.

- Netting material made of biodegradable paper, plastic or cotton netting can be used to cover straw mulch. Netting should be specified judiciously since birds, snakes and other wildlife can get trapped in the nettings.
- Polymer tackifiers are generally applied at rates of 40–60 pounds per acre, however manufacturers recommendations vary. Organic tackifiers are generally applied at rates of 80–120 pounds per acre, however manufacturer’s recommendations vary. Applications of liquid mulch binders should be heavier at edges, in valleys, and at crests of banks and other areas where the mulch could be moved by wind or water. All other areas must have a uniform application of the tackifier.

Wood Chips or Bark

Apply at a rate of 5–8 tons per acre.

The mulch should be evenly distributed across the surface to a depth of about 2 inches.

If decomposition, soil building and revegetation are desired, increase the application rate of nitrogen fertilizer by 20 pounds of nitrogen per acre, to compensate for the temporary diversion (loss) of available nitrogen to the soil microbes.

Hydraulic Mulches

Hydraulic mulches can be made of recycled newsprint, magazines, wood or other wood/paper waste sources. This type of mulch is to be mixed in a hydraulic application machine (hydroseeder) and applied as a liquid slurry that contains the recommended rates of seed and fertilizer for the site. It can be specified with or without a tackifier.

Apply at rate of 1.5 to 2 tons per acre—mixed with seed and fertilizer at recommended rates—to achieve uniform, effective coverage.

Paper mulch used to tack and bind straw mulch can be specified at a lower rate (i.e., about 750 pounds per acre).

Hydraulic mulches from wood and paper fiber are combination mulches generally composed of 70 percent wood fiber and 30 percent paper fiber, manufactured from lumber mill waste, virgin wood chips, recycled newsprint, office paper and other waste paper. The mulch is mixed in a hydraulic application machine (hydroseeder) and applied as a slurry in combination with the recommended seed and fertilizer. The mulch can be specified with or without a tackifier.

Wood, paper or combination fiber mulches are typically applied with a hydraulic applicator (hydroseeder) at a minimum rate of 1.5 tons per acre. A typical construction specification and application for this type of mulch is as follows:

- Moisture content (total weight basis) not to exceed 12 percent +/- 3 percent.
- Organic matter content (oven dry weight basis) is 98 percent minimum.
- Inorganic matter (ash) content (oven dried basis) 2 percent maximum.
- pH at 3 percent consistency in water should be 4.9 or greater.
- Fiber must be dyed to aid in visual metering during application. The dye must be biodegradable and must not inhibit plant growth.
- Water holding capacity (oven dried basis) minimum 1.0 gallons per pound of fiber.
- The mulch must be mixed with seed and fertilizer as specified and applied at a rate

recommended by the manufacturer to achieve uniform, effective coverage and provide adequate distribution of seed.

Rock

Rock is recommended for long slopes of 2H:1V or flatter that will not support thickly seeded grass. Install non-woven geotextile on graded slope, place rock of mixed sizes on geotextile, starting at bottom and working uphill. Generally rock is not suitable for residential or other areas where aesthetics are a design consideration.

Inspection and Maintenance

Inspect weekly and repair or replace any bare areas promptly. If properly applied and anchored, little additional maintenance is required during the first few months. After high winds or significant rainstorms, mulched areas should be checked for adequate cover and re-mulched if necessary. Mulch needs to last until vegetation develops to provide permanent erosion resistant cover. Straw mulch can last from 6 months to 3 years.



Use netting to secure loose straw on steep or long slopes. Above: Good coverage with straw mulch. Mulch alone can reduce erosion by more than 90 percent. Apply temporary or permanent mulch as soon as final grade is established.



Visually inspect mulched areas to ensure uniform, sufficient coverage. Application must cover all bare areas, with less than 5 percent soil showing through mulch cover.

Good use of straw mulch and grass seed in relatively flat and fairly wide swale. For more concentrated flows, triple seed the ditch and use erosion control blankets.



4.4 Soil Stabilization

4.4.4 Sodding



Sod reduces erosion potential to near zero. Make sure the surface is properly prepared with appropriate soil amendments; use fresh sod and keep well watered during the first 2 weeks after application.



Definition

Sod consists of rectangular strips of live turf grass held together by matted roots laced through an organic, growing medium.

Purpose

The purpose of sodding is to immediately establish a permanent turf grass cover over bare soil and improve visual aesthetics, during almost any time of year; to prevent erosion and damage from sediment and runoff by stabilizing the soil surface, and to promote the infiltration of precipitation and reduction of stormwater runoff; to reduce the production of dust and mud associated with bare soil surfaces; to stabilize swales, ditches, and channels where concentrated flows will occur; and to protect areas around drop inlets from muddy inflows.

Design Criteria

- Sod should be machine-cut and contain one-half inch to 1 inch of soil, not including roots or shoots or thatch.
- Specify that sod will be installed within 36 hours of digging and removal from the field.
- Avoid planting when subject to frost heave or hot weather if irrigation is not available.
- Sod should not be used on slopes steeper than 2H:1V. If it is to be mowed, installation should be on slopes no greater than 3H:1V.

Construction Specifications

Cutting and Handling Sod

The sod should consist of strips of live, vigorously growing grasses. The sod should be free of noxious and secondary noxious weeds and should be obtained from good, solid, thick-growing stands. The sod should be cut and transferred to the job in the largest continuous pieces that will hold together and that are practical to handle.

- The sod must be cut with smooth, clean edges and square ends to facilitate laying and fitting. The sod must be cut to a uniform thickness of not less than three-fourths of an inch measured from the crown of the plants to the bottom of the sod strips for all grasses except bluegrass. Bluegrass sod must be cut to a uniform thickness of not less than 1.5 inches.
- The sod must be mowed to a height of not less than 2 inches and no more than 4 inches before cutting.

- The sod must be kept moist and covered during hauling and preparation for placement on the sod bed.

Site Preparation

Soils in areas to be sodded must be capable of supporting permanent vegetation and must consist of at least 25 percent silt and clay to provide an adequate amount of moisture-holding capacity. An excessive amount of porous sand will not consistently provide sufficient moisture for the sod regardless of other soil factors.

- Compacted soils must be broken up sufficiently to create a favorable rooting depth of 6–8 inches.
- Stockpile topsoil to apply to sites that are otherwise unsuited for establishing vegetation.
- Grade as needed and feasible to permit the use of conventional equipment for the sod bed preparation. After the grading operation, spread topsoil where needed.

Sod Bed Preparation

Apply lime (in lieu of a soil test) on acid soil and subsoil at a rate of one ton per acre. The lime should be agricultural ground limestone or equivalent. For best results, conduct a soil test. This can reduce expense of unneeded lime and fertilizer and potential excess nutrient loss through runoff and leaching.

- Apply fertilizer (in lieu of a soil test) at 1,000 pounds per acre of 10-10-10 analysis. For best results, conduct a soil test.
- Work lime and fertilizer into the soil with a disk harrow, springtooth harrow, or other suitable field equipment to a depth of 4 inches.
- Before sodding, the soil surface must be cleared of all trash, debris, and stones larger than 1.5 inches in diameter, and of all roots, brush, wire, and other objects that would interfere with the placing of the sod.
- After the lime and fertilizer have been applied and just before laying the sod, the soil in the area to be sodded must be loosened to a depth of one inch. The soil must be thoroughly dampened immediately after the sod is laid if it is not already in a moist condition.

Placing Sod

No sod should be placed when the temperature is below 32° F. No frozen sod must be placed nor should any sod be placed on frozen soil.

- Sod should be carefully placed and pressed together so it will be continuous without any voids between the pieces. Stagger the joints between the ends of strips in a brick-like pattern. Ensure that the edge of the sod at the outer edges of all gutters is sufficiently deep so that the surface water will flow over onto the top of the sod.
- For channel sodding, carefully place the sod on rows or strips at right angles to the centerline of the channel (i.e., at right angles to the direction of flow). On steep, graded channels, stake each strip of sod with at least two stakes not more than 18 inches apart. The stakes should be wooden and approximately 1/2" x 3/4" x 12". Drive the stakes flush with the top of the sod and with the flat side against the slope.
- On slopes 3:1, or steeper, and where drainage into a sod gutter or channel is one-half acre or larger, roll or tamp the sod and then peg chicken wire, jute, or other netting over the sod for protection in the critical areas. Stake the netting and sod with at least two stakes not more than 18 inches apart. The stakes should be wooden and approximately 1/2" x 3/4" x 12". Drive the

stakes with the flat side against the slope and on an angle toward the slope. Staple the netting on the side of each stake within 2 inches of the top of the stake, then drive the stake flush with the top of the sod.

- The sod should be tamped or rolled after placing and then watered. Watering must consist of a thorough soaking of the sod and of the sod bed to a depth of at least 4 inches. Maintain the sod in a moist condition by watering for a period of 30 days.

Inspection and Maintenance

Inspect sod twice a week after installation to check on moisture conditions and grass viability. Irrigate sod immediately after installation and every few days afterwards if no significant rainfall occurs during the first 2 weeks. Soak the area thoroughly to a depth of 3 inches during irrigation.

- Where sodding does not establish properly, remove the old sod and resod the area as soon as possible. Identify the cause of the failure and correct it as soon as possible.
- Once established, initiate a regular maintenance program for fertilization (if needed) and mowing.

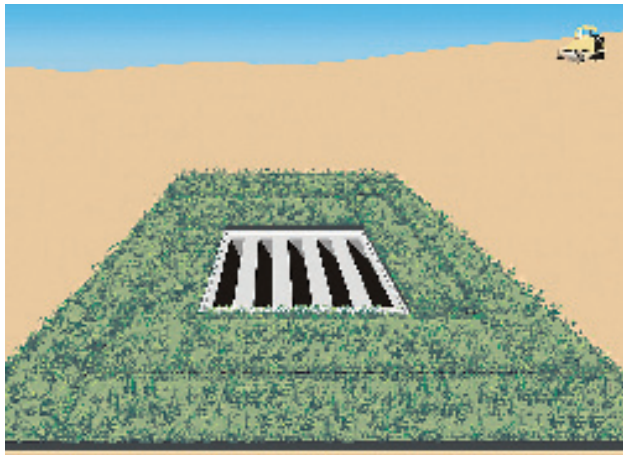

Use sod in ditches and around drop inlets for superior protection against scouring flows. Sod slows down concentrated flows and promotes filtration and settling of sediment-laden runoff.



Rolled sod should be moist, flexible, green, and fresh. For best results, install as soon as possible after final grade is established.

4.4 Soil Stabilization

4.4.5 Polyacrylamides



Long, bare slopes need to be stabilized. Polyacrylamide offers excellent temporary protection for slopes that will not be seeded or mulched immediately. Do not use near creeks, rivers, or wetlands. Follow manufacturer's instructions.



Definition

The land application or stormwater application of products containing anionic polyacrylamide (PAM), a chemical agent that binds soil particles together, which reduces erosion in the field and promotes coagulation and rapid settling in sedimentation basins.

Purpose

Land application of PAM is performed to reduce soil surface erosion due to wind or water forces. Stormwater applications of PAM promote settling of fine soil particles in sediment basins. Polyacrylamides are applied directly—via liquid spray or hand or mechanical spreader for the dry product—to bare soil areas where the timely establishment of vegetation might not be feasible or where vegetative cover is absent or inadequate. Such areas can include construction sites where land-disturbing activities prevent the establishment or maintenance of a vegetative cover. For stormwater treatment, PAM can be applied to stormwater as it enters sediment basins. This will cause soil particles to bind together and settle within the pond.

This temporary practice is not intended for application to surface waters or ditches that lead directly to surface waters. It is intended for application within construction stormwater drainage systems that feed into pre-constructed sedimentation (detention or retention) ponds or basins.

Design Criteria

Only the anionic form of PAM should be used. Cationic PAM is toxic and should NOT be used. PAM and PAM mixtures should be environmentally benign, harmless to fish, wildlife, and plants. PAM and PAM mixtures should be noncombustible.

PAM is typically applied at construction sites with temporary seeding or mulching on areas where the timely establishment of temporary erosion control is so critical that seedings and mulching need additional reinforcement. It can be used alone on sites where no disturbances will occur until site work is continued and channel erosion is not a significant potential problem. Permanent grassing applications can be better established using PAM as a tackifier and soil conditioner.

Anionic PAM is available in emulsions, powders, and gel bars or logs. Other BMPs must be used in conjunction or combination with anionic PAM, such as mulch, sediment basins, and eventually seed or other cover. The use of seed and mulch for additional erosion protection beyond the life of the anionic PAM is recommended. Repeat application if disturbance occurs to the target area. The following recommendations relating to design can enhance PAM use and help prevent problems:

- Use 25-foot minimum setbacks when applying anionic PAM near natural water bodies, such as creeks, ponds, lakes, wetlands, and rivers.
- Consider that performance of PAM decreases with time and exposure to ultraviolet light.
- In concentrated flow channels, the effectiveness of PAM decreases.
- Mulch to protect seed if seed is applied with anionic PAM.
- Never add water to PAM; add PAM slowly to water. If water is added to PAM, clumping can form, which can clog dispensers. This signifies incomplete dissolving of the PAM and increases the risk of under-application.
- Using PAM logs or block formulations is effective in removing colloidal clay, nutrients, and metals in sediment basins. Passive addition of PAM to incoming basin flows must be managed carefully by monitoring logs, blocks, or other application methods. Basin or pond systems featuring baffles or grids that slow stormwater movement through the detention area provides extended treatment or settling times and better performance. Level spreader applications provide a similar level of contact and treatment time.

Construction Specifications

Application rates should be uniform and conform to manufacturer's guidelines for application. Anionic PAM, in pure form, should have less than or equal to 0.05 percent acrylamide monomer by weight, as established by the Food and Drug Administration and EPA. To maintain less than or equal to 0.05 percent of acrylamide monomer, the maximum application rate of PAM, in pure form, should not exceed 200 pounds per acre per year. Do not over-apply PAM. Excessive application of PAM can lower the infiltration rate or suspend solids in water rather than promoting settling.

- Users of anionic PAM should obtain and follow all Material Safety Data Sheet requirements and manufacturer's recommendations. Additives to PAM such as fertilizers, solubility promoters, or inhibitors, should be nontoxic. The manufacturer or supplier should provide written application methods of PAM and PAM mixtures. The application method should ensure uniform coverage to the target and avoid drift to non-target areas including waters of the state. The manufacturer or supplier should also provide written instructions to ensure proper safety, storage, and mixing of the product.
- Gel bars or logs of anionic PAM mixtures can be used in ditch systems. This application should meet the same testing requirement as anionic PAM emulsions and powders. Effectiveness is reduced in steeply sloping ditches.
- To prevent exceeding the acrylamide monomer limit in the event of a spill, the anionic PAM in pure form should not exceed 200 pounds/batch at 0.05 percent acrylamide monomer or 400 pounds per batch at 0.025 percent acrylamide monomer.

Inspection and Maintenance

Inspect the area before anticipated storm events (or series of storm events such as intermittent showers over one or more days), within 24 hours after the end of a rainfall event of one-half inch or more, and at least once every 14 calendar days. Maintenance needs that are identified in inspections or by other means must be accomplished before the next storm event if possible, but in no case more than 7 days after the need is identified. Maintenance consists of reapplying anionic PAM to disturbed areas including high-use traffic areas that interfere with the performance of this practice.

4.4 Soil Stabilization

4.4.6 Dust Control



Apply water, polyacrylamide, or other stabilizers to bare areas if windblown dust will be a problem. Heavy dust blowing toward downwind homes can result in complaints to regulatory authorities.



Definition

Dust control is the reduction of windborne sediment and dust movement during land clearing, grading, excavation, fill placement, demolition, and other construction activities.

Purpose

The purpose of dust control is to prevent the airborne movement of sediments to off-site areas or on-site areas without sediment control where they could subsequently be washed into surface waters. Dust control should be planned in association with earthmoving or site grading activities and areas with frequent construction traffic.

Design Criteria

Construction activities must be phased to minimize the total exposed soil area and the length of time bare areas are exposed, thereby reducing erosion due to air and water movement.

- Existing trees, shrubs, and ground cover must be retained as long as possible during construction. Initial land clearing should be conducted only in those areas to be regraded or where construction is to occur. Areas to be cleared only for new vegetation or landscaping must be stabilized with seed and/or mulch immediately following clearing.
- Vegetative cover is the most effective means of dust and erosion control, when appropriate. See sections on Temporary Seed, Permanent Seed, Mulch, and Sod in this manual.
- When areas have been regraded or brought to final grade, stabilize them using temporary or permanent seed and mulch or other measures.
- Use mulch with mulch binders as an interim dust control measure in areas where vegetation might not be appropriate.
- Anionic polyacrylamide (PAM) is an effective dust control agent for undisturbed areas (see Section 4.4.5). Calcium chloride has proven effective in controlling dust on roadways, but repeat applications are necessary and the product could restrict establishment of vegetation on treated areas. A permit might be needed for using calcium chloride.
- Salt solutions such as magnesium chloride, calcium chloride, and natural brines are popular and effective dust control products for roads. Organic, nonpetroleum-based chemicals such as calcium lignosulfonate and sodium lignosulfonate are also effective. All these chemicals work best on unpaved roadways with fines in the 10 percent to 30 percent range. Petroleum-based products are not recommended because of their adverse effects on plants and water resources.

Construction Specifications

Construction roads should be watered as needed to minimize dust. Repeat applications will be necessary during dry weather.

- Roughening the soil to create ridges perpendicular to the prevailing wind direction can reduce surface wind velocities and sediment loss significantly. However, if winds shift to become parallel to the ridges, blown sediment will increase.
- Silt fences or board fencing that is perpendicular to the prevailing wind direction can also be used to lower surface wind velocities and reduce airborne sediment problems. Fences do not have to be trenched in, but may need to be 50–100 feet apart to appreciably reduce wind velocities.
- See sections on Temporary Seed, Permanent Seed, Sod, Mulch, and Construction Entrance.

Dust Control BMPs for Various Site Conditions

| Site condition | Grass/ seeding | Mulching | Watering | Chemical application | Gravel or asphalt surfacing | Silt or sand fencing | Rock pad or wash-down |
|------------------------------|-------------------|----------|----------|-------------------------|-----------------------------------|-------------------------|--------------------------|
| Disturbed areas—no traffic | ● | ● | ● | ● | ● | ● | |
| Disturbed areas—with traffic | | | ● | ● | ● | | |
| Soil stockpiles | ● | ● | ● | ● | | ● | |
| Demolition | | | ● | | | | ● |
| Clearing/ Excavation | ● | ● | ● | ● | | ● | |
| Unsurfaced roads | | | ● | ● | ● | | |
| Site exit to paved road | | | | | ● | | ● |

Inspection and Maintenance

Observe the site daily for evidence of windblown dust and take reasonable steps to reduce dust whenever possible.

- When construction on a site is inactive for a period, stabilize the site with mulch or temporary vegetation, and inspect it at least weekly for evidence of dust emissions or previously windblown sediments.
- Implement dust control measures or upgrade them if the site inspection shows evidence of wind erosion.
- Heavy rains will wash away chemical dust control products. This will require reapplication after the site dries out.

4.5 Slope Protection

General Information

Relatively flat areas—those with slopes of 2 percent or less—can be stabilized to a large extent through controlled clearing and grading, mulch, and temporary or permanent seed. Slopes greater than that, however, require more attention to sheet runoff volume and the management of areas where flows converge and are transported to downstream receiving waters. Sediment barriers, rolled erosion control products, and greater attention to downslope drainage are usually needed on slopes, especially those that are steep and long.

This section addresses erosion protection and sediment control approaches specifically for slopes. In general slopes that are long (50 feet or more), steep (5 percent plus), and composed of highly erodible (silty) soils require more protection than shorter, flatter slopes of less erodible soil. Slope protection approaches discussed below include erosion control blankets and turf reinforcement mats, which can also be used for ditch protection, surface roughening, slope drains, gabion structures, and cellular mats.

Approximate Slope Conversions

| Approximate slope conversions (horizontal:vertical) | | |
|---|-------------|---------|
| Percent | Slope Ratio | Degrees |
| 100% | 1:1 | 45° |
| 50% | 2:1 | 27° |
| 33% | 3:1 | 18° |
| 25% | 4:1 | 14° |
| 10% | 10:1 | 6° |

Slope Protection Basics

Protecting slopes from erosion requires several actions that must be taken together. No single approach will be successful, especially if the slope is steep or has highly erodible soils (see table). Use one or more of the following actions to reduce erosion on slopes:

Divert upland runoff—Install a berm or channel above the slope to divert upland rain runoff around the bare soil area or a stable ditch to move upland flows through the site without picking up additional sediment.

Control slope runoff—If slopes are broken up into benches or steps, runoff can be collected and diverted along berms or in channels to pipe or channel slope drains.

Till seedbed or condition the soil—Dozer tracks up and down slopes help hold soil in place. See the table below for information on how the condition of the soil surface (e.g., compacted, tracked) can increase or decrease erosion.

Seed and mulch—This is the best and cheapest protection by far. See temporary and permanent seeding Fact Sheets for details on seed types, application rates, and mulch, blanket, and mat products.

Silt fence or brush barrier—These should be installed at the toe of the slope, and every 75 to 125 feet apart on long slopes.

Retaining wall—Extremely steep slopes can be leveled out and shortened into two or more steps or benches by installing retaining walls of rock, brick, block, wood, logs, or other material. If rock layers are present along the slope, use these to establish firm benches in a stair-step pattern.

Blankets or armoring—Long slopes (greater than 100 feet) exceeding 3H:1V with highly erodible soils need to be protected with erosion control blankets or turf reinforcement mats. Rock mulch and lined downdrain channels might be needed on steep slopes to control gullying.

Soil Conditions vs. Erosion

| Soil Conditions vs. Erosion | |
|-----------------------------|------------------|
| If soil is: | Erosion will be: |
| Compacted and smooth | 30 percent more |
| Tracks across slopes | 20 percent more |
| Tracks up & down slopes | 10 percent less |
| Rough and irregular | 10 percent less |
| Rough & loose to 12" deep | 20 percent less |

Slope Angle and Soil Type vs. Erodibility

| Slope angle | Erodibility | Soil type |
|-------------|---|--------------|
| 50% |  | Silt |
| 40% | | Silty sand |
| 30% | | Clayey sand |
| 20% | | Organic soil |
| 15% | | Clays |
| 10% | | Silty gravel |
| 5% | | Sand |
| < 5% | Gravel | |
| | Very Low | |



The value of seed on a slope: the left (seeded) section shows almost no erosion; right side rills are quickly becoming gullies. Seed and mulch slopes as soon as final grade is established for best results. **Bare areas must be seeded or mulched within 14 days if no work is planned during the next week.**

The slope protection chart can be used to determine what type of slope protection measures should be used, given the slope angle (vertical axis) and length (horizontal axis). When addressing highly erodible (silty) soils, tend toward a more conservative approach.

Slope Protection Guidance Chart - Based on Slope Angle and Length

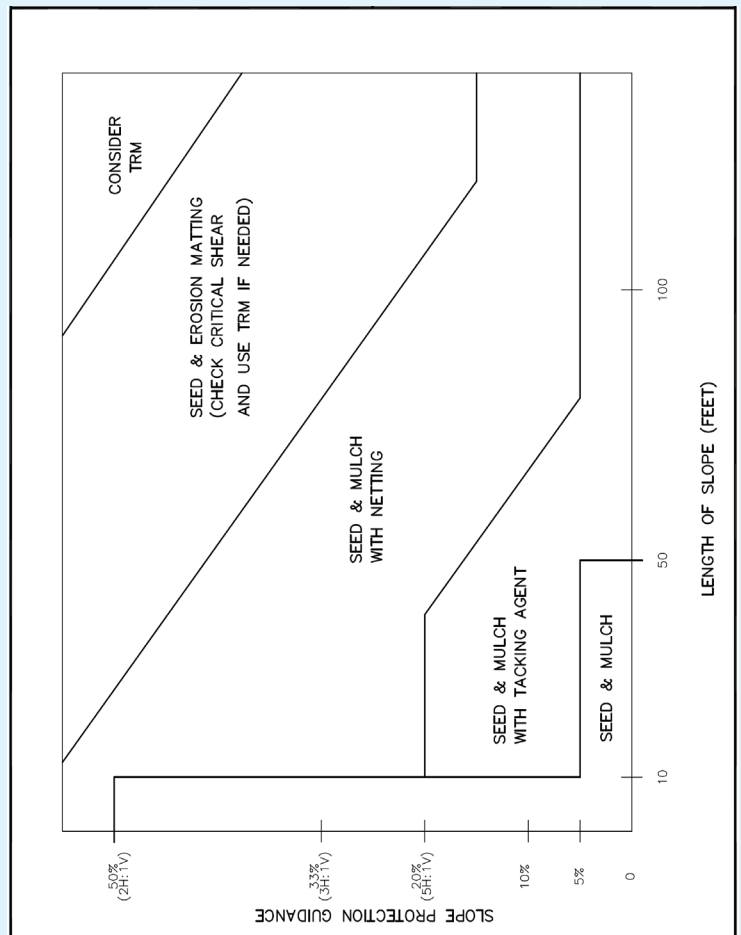

4.5 Slope Protection

4.5.1 Silt Fence



Silt fencing is commonly used to pond, settle, and filter sediment from sheet runoff. Install at proper spacing on slopes; set back from slope toe to allow for maintenance. Make sure fencing is trenched in properly and stakes are on the downhill side. Inspect frequently to detect and address bypasses, undercutting, and overtopping.

Definition

A silt fence is a temporary sediment barrier consisting of filter fabric entrenched into the soil and attached to supporting posts. Silt fences are downhill from bare soil areas and are installed with a trencher or by a slicing machine to prevent against common silt fence failures.

Purpose

Silt fences are common sediment control devices. Silt fencing should be installed where sediment-laden water can pond, thus allowing the sediment to fall out of suspension and separate from the runoff. Runoff will also *bleed through* the silt fence fabric, providing physical filtering for larger sediment particles. Reasons for the high failure rate of improperly designed (located) and installed silt fence include

- Improper placement (i.e., not on the contour, ends not turned up)
- Allowing excessive drainage area to the silt fence structure
- Shallow trenches with little or no soil compaction
- Inadequate attachment to posts
- Failure to maintain the silt fence after installation
- Installing silt fence along property boundaries, producing *concentrated* runoff

Design Criteria

Silt fencing must be installed only where water can pond. Specify silt fencing downgradient from bare soil areas, installed on the contour if possible, with the ends turned up to prevent bypassing. Provide adequate setbacks from slope toe for routine maintenance and access. Silt fencing can be used where

- Non-concentrated sheet flow will occur
- Protection of adjacent property or nearby surface waters is required
- The size of the drainage area is no more than 1/4 acre per 100 linear feet of silt fence
- The maximum flow path length above the barrier is 100 feet for slopes less than 2 percent, and 50 feet for slopes up to 10 percent

- The maximum slope gradient above the barrier is 2H:1V
- Silt fencing can be used in flat, short swales (i.e., slope is less than 2 percent; length is less than 200 feet) that drain less than 2 acres, if silt fencing is spaced every 50 feet.
- Reinforced silt fence must be required when the contributing slope is longer than 100 feet and greater than 3 percent and the design life of the silt fence is greater than 6 months.

Silt Fence Spacing on Long Slopes

| Land Slope | Max. Slope Distance |
|------------|---------------------|
| 3% – 5% | 100 ft. |
| 5% – 10% | 75 ft. |
| 10% – 20% | 50 ft. |
| 20% – 50% | 25 ft. |

Silt fencing should not be used

- Around the perimeter of large construction sites, unless J-hooks are used. Long continuous runs of silt fence will divert and concentrate sediment-laden runoff and almost certainly result in failure. A good general rule is to drain no more than 1/3 acre of disturbed area into each discrete J-hook;
- In ditches, channels, or streams. Silt fences cannot handle the volumes generated by concentrated channel flows. When installed across a concentrated flow path, undercutting or *end cutting* of the fence often occurs, or the fence is pushed over by the force of the flow.

Construction Specifications

Silt fences have a useful life of one season. Their principal mode of action is to slow and pond the water and allow soil particles to settle with some minor filtration through the fabric. Silt fences are not designed to withstand high heads of water, and therefore should be located where only shallow pools (i.e., 1.5 feet or less) can form. Their use is limited to situations in which sheet or overland flows are expected.

- Dig a trench on the contour at least 6 inches wide and 6 inches deep below the area to be treated, taking care to install J-hooks where flows will travel along the silt fence. Turn fence ends uphill to trap potential bypasses as needed.
- If posts are already attached to fabric, position the fencing so the posts are installed on the downhill side of the fabric. Drive posts to a depth of 1 foot below the bottom of the trench, against downslope trench wall for extra support. Posts for all silt fencing are spaced 6 feet apart.
- Push fabric into the trench, and spread fabric along trench bottom and sides; backfill the trench and compact the soil. A preferred installation technique in deep, easily-worked soils with minimal rock content involves static slicing of the fence into the ground with a chisel-plow implement such as the *Tommy Silt Fence Machine* or equivalent. The filter fabric is wire-tied directly to the posts with three diagonal ties.
- The height of a silt fence must be 18 inches minimum and 30 inches maximum. Sediment storage height and ponding height must not exceed 18 inches.
- Silt fences placed at the toe of a slope must be set at least 6 feet back from the toe to increase ponding volume and provide room for maintenance.

Inspection and Maintenance

All sediment barriers should be placed downgradient from bare areas to be treated. The ends of the barrier should be turned uphill or otherwise configured to prevent end-around bypasses.

- Inspect fence for proper installation and compaction by pulling up on the fence while kicking the toe of the fabric. If the fence comes out of the ground, do not accept the installation.
- If there are long, linear runs of silt fence without J-hooks, do not accept the installation.
- Silt fences and filter barriers must be inspected weekly or every 14 days and after each storm of greater than one-half inch. Any required repairs must be made immediately.
- Sediment should be removed when it reaches 1/3 height of the fence or 18 inches maximum.
- The removed sediment must be spread and vegetated or otherwise stabilized so that it does not result in muddy runoff to nearby ditches or surface waters.
- Silt fences must be removed when they have served their useful purpose, but not before the upslope area has been permanently stabilized (e.g., vegetated) and any sediment stored behind the silt fence has been removed. Silt fences and other temporary controls must be removed before project close-out.

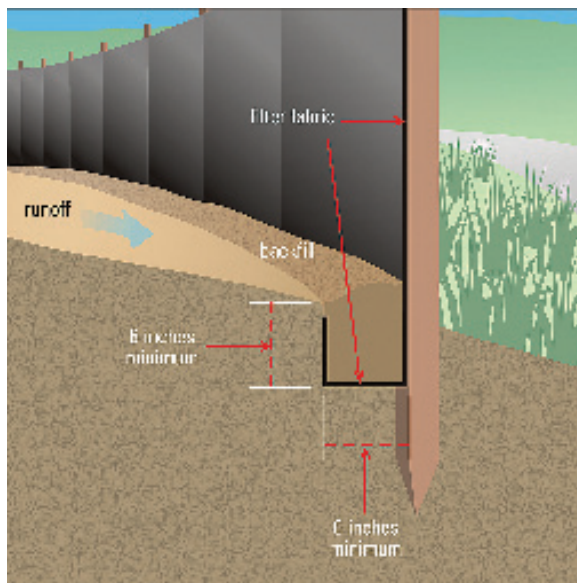

Make sure silt fence fabric is trenched in and is upslope of stakes. Leave room between the fencing and the upgradient slope for removing accumulated sediment.

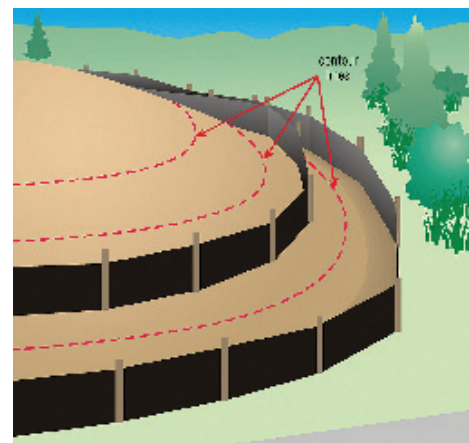

Install silt fencing on the contour, with the ends turned uphill to trap muddy runoff and prevent bypasses. Remove silt fences when grass is established.

Do not use silt fencing in areas of concentrated flows. For best results, triple-seed ditches and line with erosion control blankets.





Use several short lengths of silt fence and J-hooks to intercept converging runoff in critical areas, such as property corners. This can help relieve stress and prevent failure at the corners.



Silt fence installed backwards—note that stakes are on the uphill, rather than downhill, side of the fabric. Ponding flows against this fence will push the fabric away from the stakes, causing failure and releasing sediment to the small stream on the right.



Use multiple silt fences at proper spacing (see table) to protect long, unvegetated slopes. Fences provide only temporary protection and can be removed when the area is seeded and mulched.



Silt fence is functioning well, but needs maintenance. Set fences back from the toe of the slope, to allow room for sediment to accumulate and maintenance.



Good installation of "super" (i.e., wire reinforced) silt fence. Note that wire is installed between the fabric and stakes, and provides a web of support as the ponded flow pushes against the fabric. Also, note the grass strip between the bare area and the fence, which helps to slow and filter flows before ponding along the fence line.

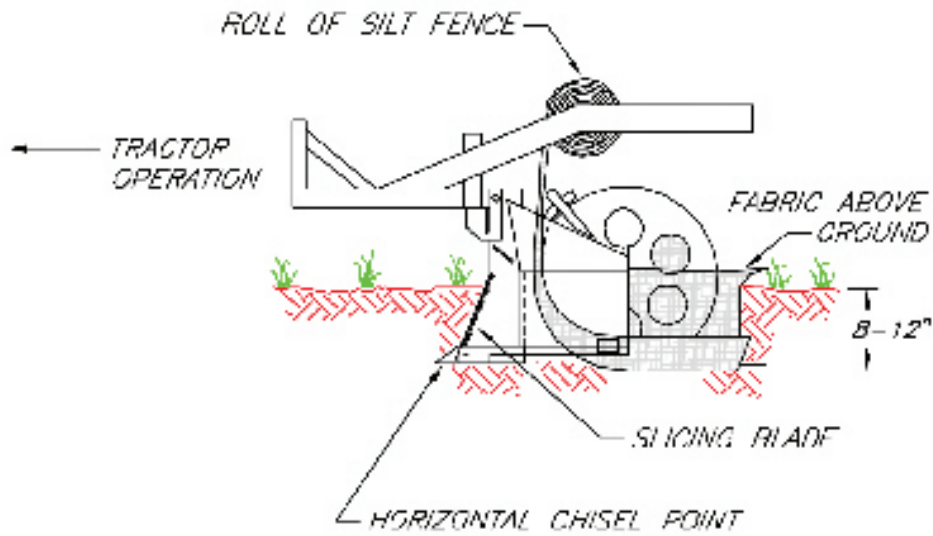

STATIC SLICING METHOD
SIDE VIEW

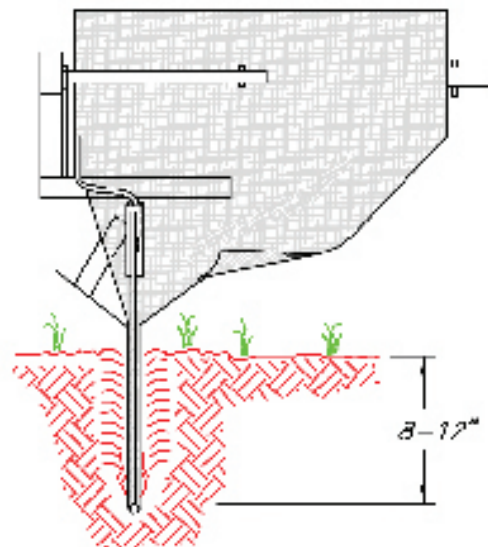

STATIC SLICING METHOD
BACK VIEW

SILT FENCE INSTALLATION: SLICING METHOD

SOURCE: SALIX APPLIED EARTH CARE -
EROSION DRAW 5.0

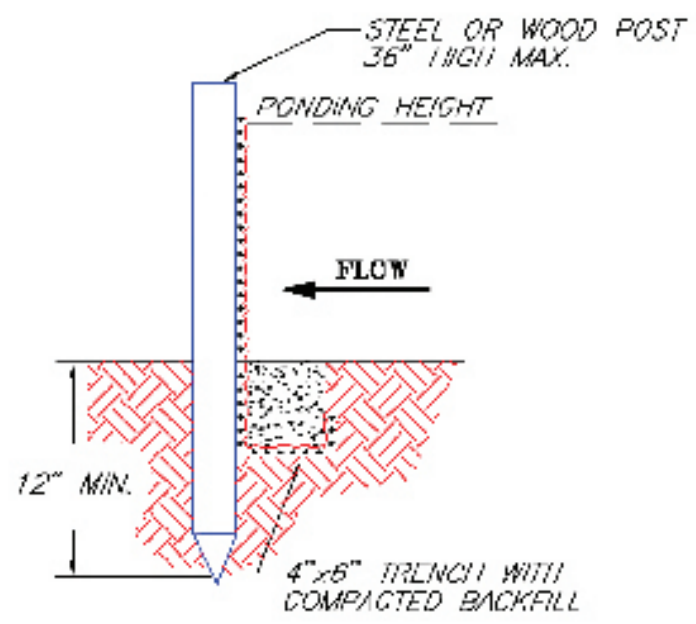
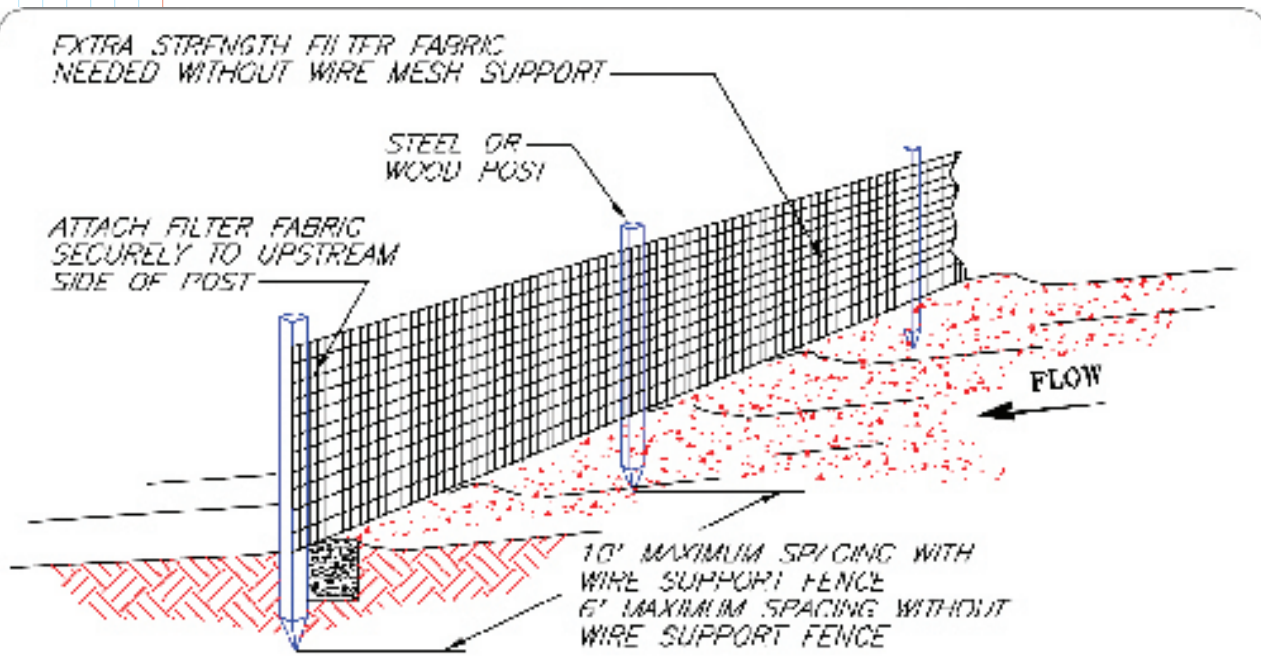

TRENCH DETAIL

NOTES:

1. SILT FENCE SHALL BE PLACED ON SLOPE CONTOURS TO MAXIMIZE PONDING EFFICIENCY.
2. INSPECT AND REPAIR FENCE AFTER EACH STORM EVENT AND REMOVE SEDIMENT WHEN NECESSARY. 5" MAXIMUM RECOMMENDED STORAGE HEIGHT.
3. REMOVED SEDIMENT SHALL BE DEPOSITED TO AN AREA THAT WILL NOT CONTRIBUTE SEDIMENT OFF-SITE AND CAN BE PERMANENTLY STABILIZED.

NOT TO SCALE

**SILT FENCE
INSTALLATION:
TRENCH METHOD**

SOURCE: SALIX APPLIED EARTHCARE -
EROSION DRAW 5.0

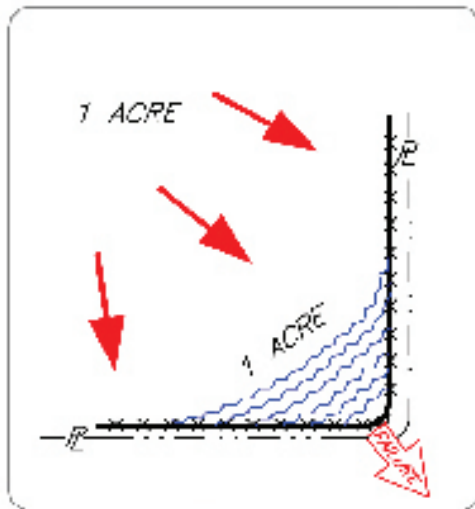

Incorrect - Do Not layout "perimeter control" silt fences along property lines. All sediment laden runoff will concentrate and overwhelm the system.

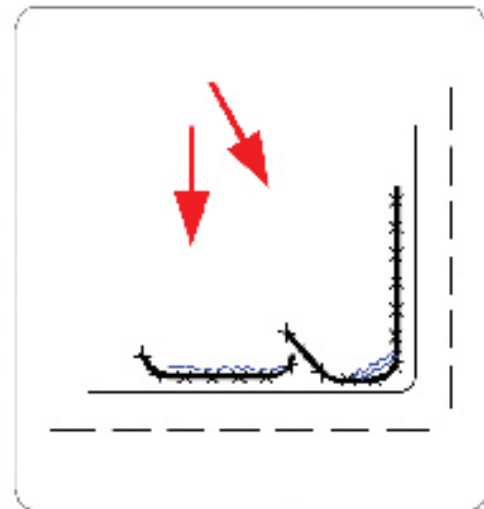

Correct - Install J-hooks

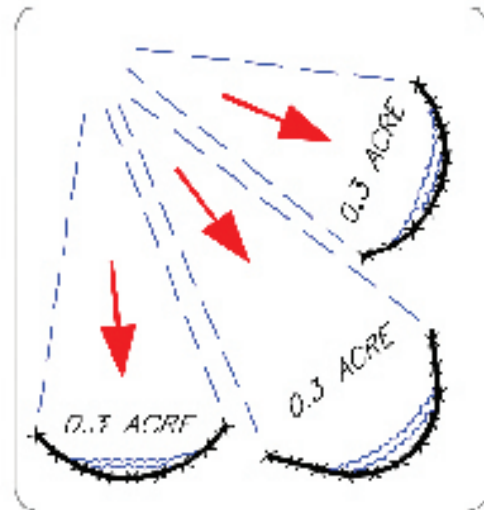
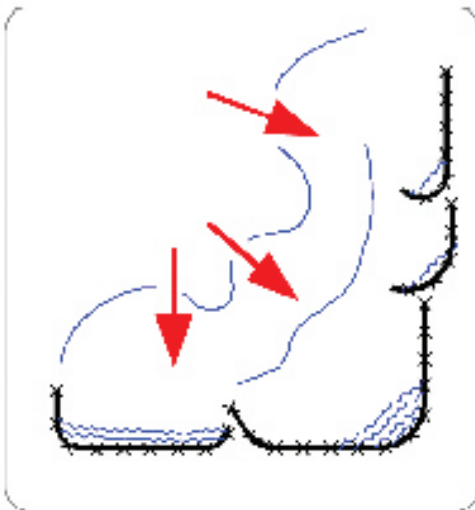

Discreet segments of silt fence, installed with J-hooks will be much more effective.

SILT FENCE PLACEMENT FOR PERIMETER CONTROL

SOURCE: SALIX APPLIED EARTHCARE -
EROSION DRAW 5.0

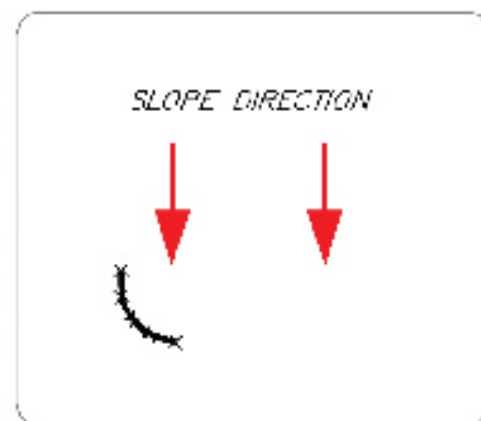
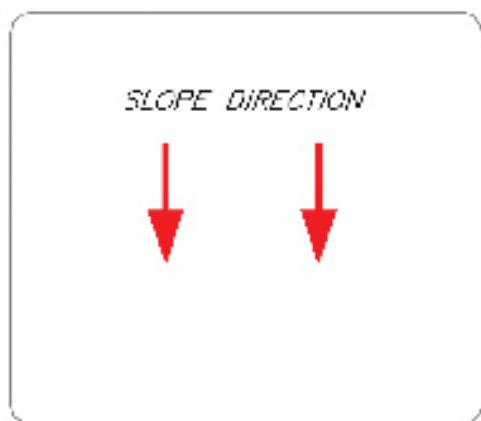

STEP 1 - CONSTRUCT LEG

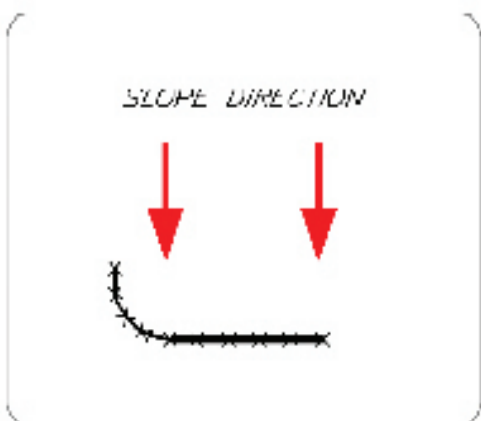

STEP 2 CONSTRUCT DAM

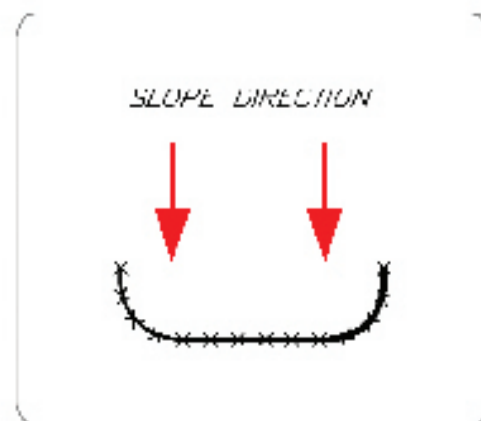

STEP 3 CONSTRUCT LEG 2

INSTALLATION WITH J-HOOKS INCREASE SILT FENCE EFFICIENCY.

SILT FENCE: TYPICAL PLACEMENT ON SLOPE

SOURCE: SALIX APPLIED EARTH CARE -
EROSION DRAW 5.0

2 SLOPE DIRECTIONS



2 SLOPE DIRECTIONS



STEP 1 - CONSTRUCT A DAM

2 SLOPE DIRECTIONS

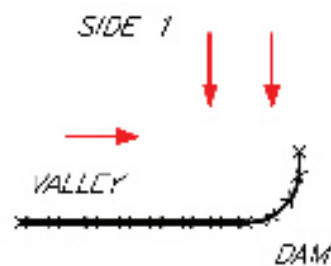

STEP 2 - CONSTRUCT SIDE 2

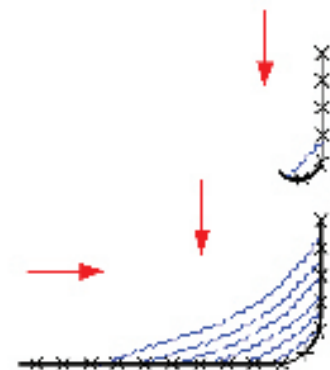

STEP 3 - CONSTRUCT J-HOOKS
AS NEEDED

INSTALLATION WITH J-HOOKS WILL INCREASE SILT FENCE EFFICIENCY AND
REDUCE EROSION-CAUSING FAILURES.

SILT FENCE: TYPICAL PLACEMENT TWO SLOPES

SOURCE: SALIX APPLIED EARTHCARE -
EROSION DRAW 5.0

4.5 Slope Protection

4.5.2 Brush, Rock, and Other Sediment Barriers



If rock will be used at the site eventually, it could be beneficial to have it delivered early for use as a sediment barrier in the vicinity of its final use. Large rock is especially useful as berming for temporary sediment traps. Other sediment barriers include brush cleared from the site, fiber (log) rolls, and other commercial products.

Definition

Brush, rock, and other commercial barriers can be used as a temporary sediment barrier instead of a silt fence.

Purpose

The purpose of any sediment barrier is to provide a place where sediment-laden water can pond, thus allowing the sediment to fall out of suspension and separate from the runoff.

Design Criteria

Sediment barriers should be installed where non-concentrated sheet flow will occur. They should not be used in ditches, channels, or streams unless they can withstand predicted flows. Sediment barriers are usually placed a few feet beyond the toe of a slope, or across long slopes at specific intervals. When placing sediment barriers, consider materials on hand that might be used (e.g., brush cleared from the site, shot rock) during initial clearing and grading work. Silt fences or commercial sediment barrier products should be sited far enough away from the toe of the slope to allow for maintenance (i.e., access by a small loader, truck). There are several other factors to consider in placing silt fences, rock sediment filters, or other commercial sediment barriers:

- Place filters on downhill edge of bare soil areas.
- Make sure the filter catches all the muddy runoff.
- Turn the ends of the barrier uphill to prevent bypasses
- The goal is to pond runoff, to filter and settle it out.
- Install multiple sediment filters on long slopes.
- Spacing on long slopes is every 50 to 100 feet.
- Put filters across slopes, on the contour (level).

Placement criteria are similar to those specified for silt fences (see the preceding section).

Construction Specifications

Brush cleared from the site can make an excellent sediment filter if it is properly placed and built up well. Brush barriers are installed on the contour and are 2–5 feet high and 4–10 feet wide at the base. They should be trenched in and walked down with a loader or dozer to compress the material.

A rock berm can also provide an effective and low-maintenance sediment barrier. Rock berms placed in concentrated flow areas function as sediment traps (for more information on that type of application, see Section 4.7.1). Longer rock berms constructed as sheet runoff sediment barriers should be 18" to 30" in height and consist of stone 2–6 inches in diameter.

Fiber rolls and other commercial products made from coconut fiber, plastic, wood shavings, compost, or other material can also be used as sediment barriers on slopes. Follow manufacturers' installation instructions and ensure that sediment filter spacing on slopes is correct--spacing decreases significantly on slopes >10:1.

For information on locating and installing rock or commercial barriers, see construction specifications for silt fences in the preceding section.

Inspection and Maintenance

Sediment barriers should be inspected weekly and after each rainfall of greater than one-half inch. Look for signs of bypassing along the sides, undercutting below the barrier, overtopping, or blowout. Make required repairs immediately. For recurring blowouts, consider pulling some upland muddy flow away and trapping it before it can reach the blowout area. Use a J-hook or other strategically placed barrier.

Remove sediment when it reaches 1/3 height of the fence or 9 inches maximum. Spread the removed sediment and vegetate or otherwise stabilize it.

Remove sediment barriers when they have served their useful purpose but not before the upslope area has been permanently stabilized (i.e., vegetated or otherwise covered) and any sediment stored behind the barrier has been removed.

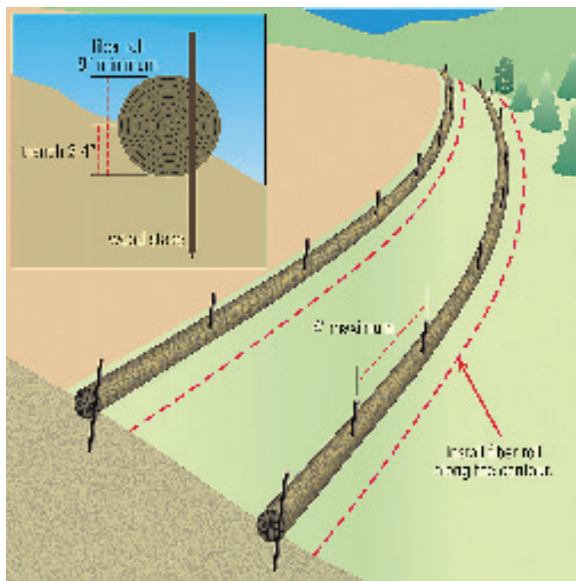

Fiber rolls provide excellent protection for residential lots. They can be stepped over and driven over, and are preferable to silt fencing in tight areas.



Brush cleared from the site used as a temporary downslope sediment barrier. Make sure barrier intercepts and ponds up muddy runoff. Remove when grass is established.



Super (wire reinforced) silt fence in the foreground, supplemented by rock sediment barrier (background). Use rock or other sediment barriers when appropriate.

4.5 Slope Protection

4.5.3 Erosion Control Blankets and Turf Reinforcement Mats



Erosion control blankets provide excellent protection for seedbeds, especially on slopes and in areas of high winds. Blankets can be used to stabilize ditches with flatter slopes. For steeper ditches, use turf reinforcement mats.

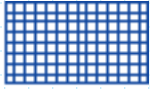

Definition

Temporary erosion control blankets (ECBs) and permanent turf reinforcement mats (TRMs), known generally as rolled erosion control products, are single or multiple layer sheets composed of natural or synthetic material that is woven, sewn, bonded, or otherwise manufactured for placement on bare soil slopes or flow channels. ECBs have been described as temporary, degradable products composed of processed natural or polymer fibers mechanically, structurally, or chemically bound together to form a continuous matrix to provide erosion control and facilitate vegetation establishment.

Purpose

ECBs are used to temporarily stabilize and protect disturbed soil from raindrop impact and surface erosion, to increase infiltration, decrease compaction and soil crusting, and to conserve soil moisture. ECBs will increase the germination rates for grasses and legumes and promote vegetation establishment. ECBs also protect seeds from predators, reduce desiccation and evaporation by insulating the soil and seed environment.

Some types of ECBs and turf reinforcement mats are specifically designed to stabilize channelized flow areas. These blankets and mats can aid the establishment of vegetation in waterways and increase the maximum permissible velocity of the given channel by reinforcing the soil and vegetation to resist the forces of erosion during runoff events. Stems, roots and rhizomes of the vegetation become intertwined with the mat, reinforcing the vegetation and anchoring the mat.

Design Criteria

All final slopes 2H:1V or steeper should be protected with an ECB or TRM. ECBs are constructed of various degradable organic / synthetic fibers that are woven, glued or structurally bound with nettings or meshes. The most widely used ECBs are made from straw, wood excelsior, coconut, polypropylene or a combination thereof stitched or glued together or into or between biaxially oriented process nettings or woven natural fiber nettings. They are useful on sites requiring greater, more durable or longer-lasting erosion protection. Applications include gradual to steep slopes, low to moderate flow channels and low-impact shore linings. Because these degradable materials are designed to provide temporary erosion protection, they generally are limited to areas where natural, unreinforced vegetation alone will provide long-term soil stabilization.

The functional longevity of ECBs can be varied to accommodate the site-specific requirements. Some ECBs are designed to last less than 3 months for use in high-maintenance areas that will be mowed soon after turf establishment, while others are made to provide longer-lasting protection in applications requiring erosion control/mulch for up to 3 years.

Permanent TRMs consist of various UV-stabilized, synthetic fibers and filaments processed into permanent, high-strength, 3-D matrices. Common examples include cusped polyethylene meshes heat-bonded together, extruded monofilaments of nylon or PVC heat-bonded at their intersections, and crimped polyolefin fibers and other materials mechanically stitched between high-strength nettings. TRMs are designed for permanent and critical hydraulic applications such as drainage channels, where design discharges exert velocities and shear stresses that exceed the limits of mature, natural vegetation. Though some TRMs also contain degradable components to supplement their permanent structures, all TRMs by definition have a permanent three dimensional structure with high-tensile strength that functions as a matrix for entangling plant roots, stems and soils.

Together, the TRM and vegetation form a continuous composite—a unified, living mat. This synergism increases root systems' lateral strength, reducing plant dislodgement under high-velocity, high-shear stress flows. The TRM's permanent structure also functions to consolidate and protect the soils in which the plants are anchored, preventing soil from being stripped out of the vegetative cover and the resulting weakening of the root support. TRMs are often used in situations where the *green* alternative is preferred to hard armor.

Select the ECB or TRM according to slope steepness and length and expected shear stress if application is to a flow channel or ditch. If the area will be mowed eventually, consider the specified breakdown time for ECB plastic netting. TRM areas should not be mowed until vegetation is well established, and then as little (or as high) as possible. The table at the end of this section provides guidance on the application of various blankets and mats. An ECB or TRM should be used in all drainage channels with slopes of 2 percent or more, and in the following conditions:

- Slopes and disturbed soils where mulch anchoring is difficult and other methods such as crimping or tackifying are not feasible nor adequate
- Steep, long slopes, generally steeper than 3H:1V and longer than 50 feet
- Slopes where erosion hazards are high
- Critical slopes adjacent to sensitive areas such as streams and wetlands
- Disturbed soil areas where planting is likely to be slow in providing adequate protective cover

Take care to choose the type of blanket or matting that is appropriate for the specific needs of a project. There are many soil stabilization products available today, and it is very difficult to cover all the advantages, disadvantages and specifications of all the manufactured blankets and mats. Therefore, as with many erosion control type products, there is no substitute for a thorough understanding of manufacturer's instructions and recommendations and a site visit by a designer or plan reviewer to verify a product's appropriateness. See table in this section for details.

Construction Specifications

ECBs and TRMs are designed to cover germinating seed and provide a protective matrix that helps anchor seed to the underlying soil. (Note: a few ECBs have seed embedded in the mat.) This requires complete, uniform contact with the soil, solid stapling, and attention to topslope anchoring, overlaps, and other installation details, as noted below.

Site Preparation

Proper site preparation is essential to ensure complete contact of the protection matting with the soil.

- Grade and shape area of installation

- Remove all rocks, roots, clods, vegetative, or other obstructions so that the installed blankets or mats will have direct contact with the soil
- Prepare seedbed by loosening 2–3 inches of topsoil above final grade
- Incorporate amendments, such as lime and fertilizer, into soil according to soil test and the seeding plan, then seed the area

Seeding

Seed the area before installing blanket for erosion control and revegetation. (Seeding after mat installation is sometimes specified for turf reinforcement application—check the manufacturer’s instructions). When seeding before blanket installation, reseed all check slots and other areas disturbed during installation.

Where soil filling is specified for certain TRMs, seed the matting and the entire disturbed area after installation and before filling the mat with soil. Follow the manufacturer’s instructions to ensure proper installation.

Anchoring

U-shaped wire staples, metal geotextile stake pins, or triangular wooden stakes can be used to anchor ECBs and TRMs to the ground surface. Wire staples should be a minimum of 11 gauge. Metal stake pins should be 3/16 inch diameter steel with a 1.5 inch steel washer at the head of the pin. Wire staples and metal stakes should be driven flush to the soil surface. All anchors should be 6–8 inches long and have sufficient ground penetration to resist pullout. Longer anchors might be required for loose soils. Use biodegradable composite or wooden stakes where dislodged metal staples or stakes might cause extreme hazards, such as near airport runways or areas where future mowing might cause risk.

Installation on Slopes

Begin at the top of the slope and anchor the blanket in a 6 inch deep by 6 inch wide trench. Backfill trench and tamp earth firmly.

- Unroll blanket downslope in the direction of the water flow.
- The edges of adjacent parallel rolls must be overlapped at least 3 inches and be stapled through the overlapped area at least every 3 feet on slopes less than 4H:1V and every 2 feet on steeper slopes.
- When blankets must be spliced, place uphill blanket end over downhill blanket (shingle style) with 6-inch overlap. Staple through overlapped area, approximately 12 inches apart.
- Lay blankets and mats loosely and maintain direct contact with the soil—do not stretch. Ensure good, consistent, direct soil contact.
- ECBs and TRMs must be stapled sufficiently to anchor the blanket and maintain contact with the soil. Staples must be placed down the center and staggered with the staples placed along the edges. Steep slopes (1H:1V to 2H:1V) require at least two staples per square yard. Moderate slopes (2H:1V to 3H:1H) require 1-2 staples per square yard (1 staple 3 every feet on center). Flatter slopes require one staple per square yard.

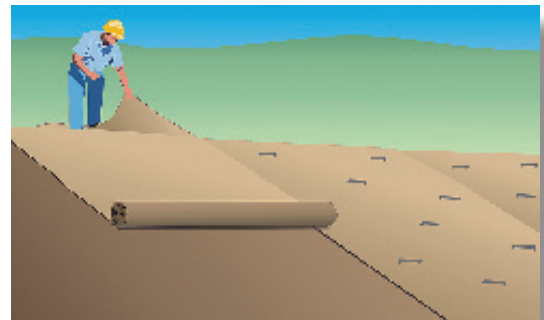

Install blankets and mats vertically on long slopes. Trench and staple top section, overlap sides 3 to 6 inches. Follow manufacturer’s directions regarding stapling and slope limitations. For areas that will be mowed, specify blankets without plastic netting or material designed to decompose within 6 months.

Installation in ditches and channels

Dig initial check slot trench 12 inches deep and 6 inches wide across the channel (i.e., perpendicular to the flow direction) at the lower end of the project area. Seed area first, if specified for the type of TRM or ECB used.

- Excavate intermittent check slots, 6 inches deep and 6 inches wide across the channel at 25–30 foot intervals along the channel.

- Cut longitudinal channel anchor slots 4 inches deep and 4 inches wide along each side of the installation to bury edges of matting. These anchor slots will mark the upper elevation of the ECB or TRM along the channel side slopes, and should be above the 10 year, 24-hour peak flow line. Whenever possible extend the ECB or TRM 1 foot or more above the crest of channel side slopes.

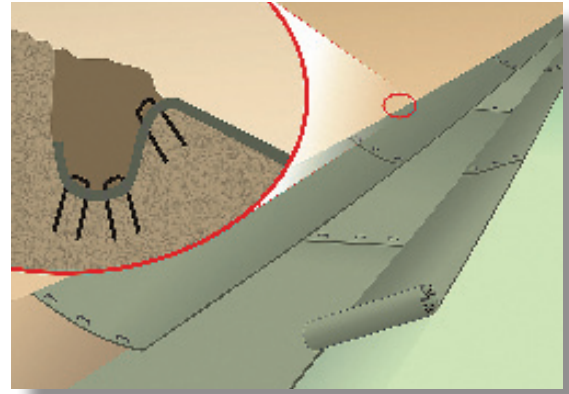

Ditch installation for blanket or mat. Triple-seed ditch, trench in upslope blanket sides, and staple down securely. Lay ditch sections horizontally, lapping upslope sections over downslope sections. Use plenty of staples below the water line.

- Beginning at the downstream end and in the center of the channel, place the initial end of the first roll in the anchor trench and secure with fastening devices at 1-foot intervals. Note: Matting will initially be upside down in anchor trench.
- In the same manner, position adjacent rolls in the anchor trench, overlapping the preceding roll a minimum of 6–8 inches.
- Secure these initial ends of mats with anchors at 1-foot intervals, backfill and compact soil.
- Unroll the center strip of matting upstream. Stop at the next check slot or terminal anchor trench.
- Unroll adjacent mats upstream in similar fashion, maintaining a 3-inch overlap.
- Fold and secure all rolls of matting snugly into all transverse check slots. Lay the mat in the bottom of the slot then fold back against itself. Anchor through both layers of mat at 1-foot intervals, then backfill and compact the soil. Continue rolling all mat widths upstream to the next check slot or terminal anchor trench.
- Alternate method for noncritical installations: place two rows of anchors on 6-inch centers at 25–30 feet intervals in lieu of excavated check slots. Shingle-lap the spliced ends by a minimum of 1 foot with the upstream mat on top (to prevent uplifting by water) or begin new rolls in a check slot. Anchor the overlapped area by placing two rows of anchors, 1 foot apart on 1-foot intervals.
- Place the edges of outside mats in previously excavated longitudinal slots, anchor them using the prescribed staple pattern, then backfill and compact the soil.
- Anchor, fill, and compact the upstream end of the mat in a 12-inch by 6-inch terminal trench.
- Secure the mat to the ground using U-shaped wire staples, geotextile pins, or wooden stakes. (Note: some TRMs require seeding after installation--check manufacturer's requirements).
- Spread and lightly rake one-half to three-quarter inch of fine topsoil into the mat apertures to completely fill the mat thickness. Use the backside of a rake or other flat implement. Spread topsoil using lightweight loader, backhoe, or other power equipment. Avoid making sharp turns with the equipment.
- Do not drive tracked or heavy equipment over the mat. Avoid any traffic over the matting if loose or wet soil conditions exist.
- Use shovels, rakes or brooms for fine grading and touch up. Smooth out soil filling, just exposing the top netting of matrix.

Erosion Control Technology Council Standard Specification for Temporary Rolled Erosion Control Products

For use where natural vegetation alone will provide permanent erosion protection

ULTRA SHORT TERM: Typical 3-Month Functional Longevity

| Type | Product Description | Material Composition | Slope Applications* | | Channel Applications* | |
|------|---------------------------------------|---|---------------------|-------------------------|---|---------------------------------------|
| | | | Maximum Gradient | C Factor ^{2,5} | Permissible Shear Stress ^{3,4,6} | Minimum Tensile Strength ¹ |
| 1.A | Mulch Control Nets | A photodegradable synthetic mesh or woven biodegradable natural fiber netting. | 5:1 (H:V) | < 0.10 @ 5:1 | = 0.25 lbs/ft ² | 5 lbs/ft |
| 1.B | Netless Rolled ECBs | Natural and/or polymer fibers mechanically interlocked and/or chemically adhered together to form a RECP. | 4:1 (H:V) | < 0.10 @ 4:1 | = 0.5 lbs/ft ² | 5 lbs/ft |
| 1.C | Single-net ECBs & Open Weave Textiles | Processed degradable natural and/or polymer fibers mechanically bound together by a single rapidly degrading, synthetic or natural fiber netting or an open weave textile of processed rapidly degrading natural or polymer yarns or twines woven into a continuous matrix. | 3:1 (H:V) | < 0.15 @ 3:1 | = 1.5 lbs/ft ² | 50 lbs/ft |
| 1.D | Double-net ECBs | Processed degradable natural and/or polymer fibers mechanically bound together between two rapidly degrading, synthetic or natural fiber nettings. | 2:1 (H:V) | < 0.20 @ 2:1 | = 1.75 lbs/ft ² | 75 lbs/ft |

SHORT-TERM: Typical 12-Month Functional Longevity

| Type | Product Description | Material Composition | Slope Applications* | | Channel Applications* | |
|------|---------------------------------------|--|---------------------|-------------------------|---|---------------------------------------|
| | | | Maximum Gradient | C Factor ^{2,5} | Permissible Shear Stress ^{3,4,6} | Minimum Tensile Strength ¹ |
| 2.A | Mulch Control Nets | A photodegradable synthetic mesh or woven biodegradable natural fiber netting. | 5:1 (H:V) | < 0.10 @ 5:1 | = 0.25 lbs/ft ² | 5 lbs/ft |
| 2.B | Netless Rolled ECBs | Natural and/or polymer fibers mechanically interlocked and/or chemically adhered together to form a RECP. | 4:1 (H:V) | < 0.10 @ 4:1 | = 0.5 lbs/ft ² | 5 lbs/ft |
| 2.C | Single-net ECBs & Open Weave Textiles | An erosion control blanket composed of processed degradable natural or polymer fibers mechanically bound together by a single degradable synthetic or natural fiber netting to form a continuous matrix or an open weave textile composed of processed degradable natural or polymer yarns or twines woven into a continuous matrix. | 3:1 (H:V) | < 0.15 @ 3:1 | = 1.5 lbs/ft ² | 50 lbs/ft |
| 2.D | Double-net ECBs | Processed degradable natural and/or polymer fibers mechanically bound together between two degradable, synthetic or natural fiber nettings. | 2:1 (H:V) | < 0.20 @ 2:1 | = 1.75 lbs/ft ² | 75 lbs/ft |

Erosion Control Technology Council Standard Specification for Temporary Rolled Erosion Control Products (continued)

For use where natural vegetation alone will provide permanent erosion protection

EXTENDED TERM: Typical 24-Month Functional Longevity

| Type | Product Description | Material Composition | Slope Applications* | | Channel Applications* | | Minimum Tensile Strength ¹ |
|------|----------------------------|---|---------------------|-------------------------|---|--|---------------------------------------|
| | | | Maximum Gradient | C Factor ^{2,5} | Permissible Shear Stress ^{3,4,6} | | |
| 3.A | Mulch Control Nets | A slow degrading synthetic mesh or woven natural fiber netting. | 5:1 (H:V) | < 0.10 @ 5:1 | = 0.25 lbs/ft ² | | 25 lbs/ft |
| 3.B | ECBs & Open Weave Textiles | An ECB composed of processed slow degrading natural or polymer fibers mechanically bound together between two slow degrading synthetic or natural fiber nettings to form a continuous matrix or an open weave textile composed of processed slow degrading natural or polymer yarns or twines woven into a continuous matrix. | 1.5:1 (H:V) | < 0.25 @ 1.5:1 | = 2.00 lbs/ft ² | | 100 lbs/ft |

LONG TERM: Typical 36-Month Functional Longevity

| Type | Product Description | Material Composition | Slope Applications* | | Channel Applications* | | Minimum Tensile Strength ¹ |
|------|----------------------------|---|---------------------|-------------------------|---|--|---------------------------------------|
| | | | Maximum Gradient | C Factor ^{2,5} | Permissible Shear Stress ^{3,4,6} | | |
| 4 | ECBs & Open Weave Textiles | An ECB composed of processed slow degrading natural or polymer fibers mechanically bound together between two slow degrading synthetic or natural fiber nettings to form a continuous matrix or an open weave textile composed of processed slow degrading natural or polymer yarns or twines woven into a continuous matrix. | 1:1 (H:V) | < 0.25 @ 1:1 | = 2.25 lbs/ft ² | | 125 lbs/ft |

NOTES:

* "C" factor and shear stress for Types 1.A., 2.A. and 3.A mulch control nettings must be obtained with netting used in conjunction with pre-applied mulch material.

1 Minimum Average Roll Values when tested in the machine direction using ECTC Modified ASTM D 5035.

2 Factor calculated as ratio of soil loss from RECP protected slope (tested at specified or greater gradient, H:V) to ratio of soil loss from unprotected (control) plot in large-scale testing. Performance test values should be supported by periodic bench scale testing under similar test conditions using ECTC Test Method # 2.

3 Minimum shear stress RECP (unvegetated) can sustain without physical damage or excess erosion (0.5 in soil loss) during a 30-minute flow event in large-scale testing. Performance test values should be supported by periodic bench-scale testing under similar test conditions and failure criteria using ECTC Test Method #3.

4 The permissible shear stress levels established for each performance category are based on historical experience with products characterized by Manning's roughness coefficients in the range of 0.01–0.05.

5 Acceptable large-scale test methods may include ASTM D6459 or other independent testing deemed acceptable by the engineer.

6 Acceptable large-scale testing protocol may include ASTM D6460 or other independent testing deemed acceptable by the engineer.

Erosion Control Technology Council Standard Specification for Permanent Rolled Erosion Control Products

For applications in ditches and channels, and on slopes not exceeding 0.5H:1V where vegetation alone will not sustain expected flow conditions and/or provide sufficient long-term erosion protection

| Product Type ¹ | Product Description | Material Composition | Minimum Tensile Strength ^{2,3} | Minimum Thickness (ASTM D 6525) | UV Stability (ASTM D 4355 @ 500 Hours) | Channel Applications Permissible Shear Stress ^{4,5} |
|---------------------------|---------------------|--|---|---------------------------------|--|--|
| 5.A | TRM | Long term, non-degradable rolled erosion control product composed of UV stabilized, nondegradable, synthetic fibers, filaments, nettings and/or wire mesh processed into three dimensional reinforcement matrices designed for permanent and critical hydraulic applications where design discharges exert velocities and shear stresses that exceed the limits of mature, natural vegetation. | 125 lbs/ft | 0.25 inches | 80% | = 6.0 lbs/ft ² |
| 5.B | TRM | | 150 lbs/ft | 0.25 inches | 80% | = 8.0 lbs/ft ² |
| 5.C | TRM | TRMs provide sufficient thickness, strength and void space to permit soil filling and/or retention and the development of vegetation within the matrix. | 175 lbs/ft | 0.25 inches | 80% | = 10.0 lbs/ft ² |

NOTES:

- For TRMs containing degradable components, all property values must be obtained on the non-degradable portion of the matting alone.
- Minimum Average Roll Values, machine direction only for tensile strength determination using ASTM D6818 (Supersedes Mod. ASTM D5035 for RECPs)
- Field conditions with high-loading and/or high survivability requirements may warrant the use of a TRM with a tensile strength of 3,000 lb/ft or greater.
- Shear stress that fully vegetated TRM can sustain without physical damage or excess erosion (0.5 in) soil loss) during a 30-minute flow in large-scale testing.
- Acceptable large-scale testing protocol may include ASTM D6460 or other independent testing deemed acceptable by the engineer.

Inspection and Maintenance

All blankets and mats should be inspected periodically following installation.

- Inspect installation after significant rainstorms to check for erosion and undermining. Any failure should be repaired immediately.
- If washout or breakage occurs, reinstall the material after repairing the damage to the slope or drainageway.

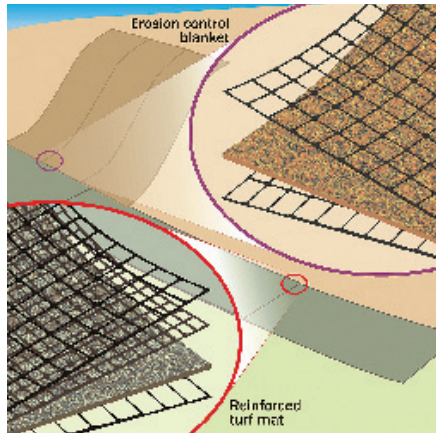

Erosion control blankets (top right) are thinner and degrade quicker than turf reinforcement mats (lower left). Blankets are used on shorter, flatter slopes and low-flow ditches. Mats can be used on steep slopes and high-velocity ditches.

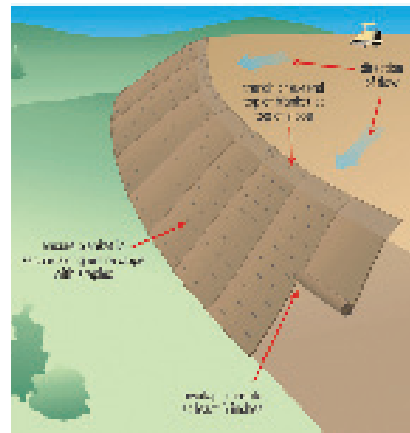

Blankets are highly recommended for long, steep slopes (i.e., longer than 75 feet and steeper than 3H:1V). Trench in top of blankets, overlap sides, and use plenty of staples. Blankets can become saturated and heavy after a rain and begin to slip down the slope if not staked securely.



Good use of straw and excelsior blankets on streambank stabilization project. Note that the bottom of stream is not disturbed to preserve habitat. This site is ready for live stakes, tree plantings, or other vegetation (see Section 4.7, Stream and Wetland Protection).

Seeding on long, steep slope protected by straw erosion control blanket. Make sure blankets are stapled down securely for these applications to prevent blankets from sliding downhill when weighted down with rain and fugitive sediment.



Very good installation of turf mat in long, steep, high-flow ditch below long slope.



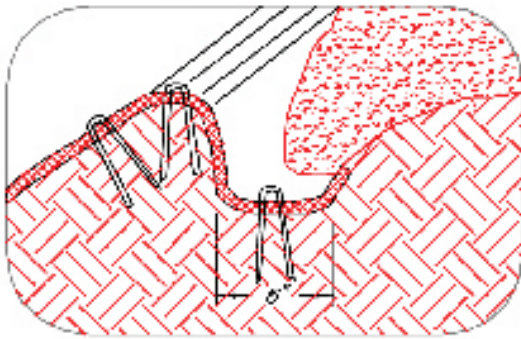

LONGITUDINAL ANCHOR TRENCH

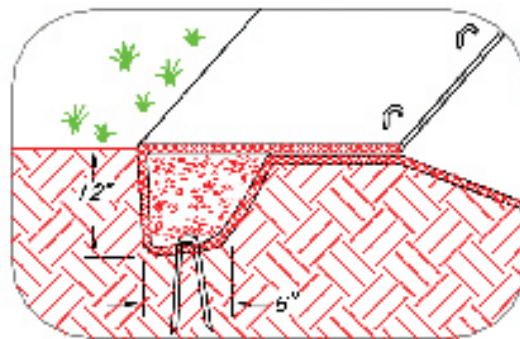

TERMINAL SLOPE AND CHANNEL ANCHOR TRENCH

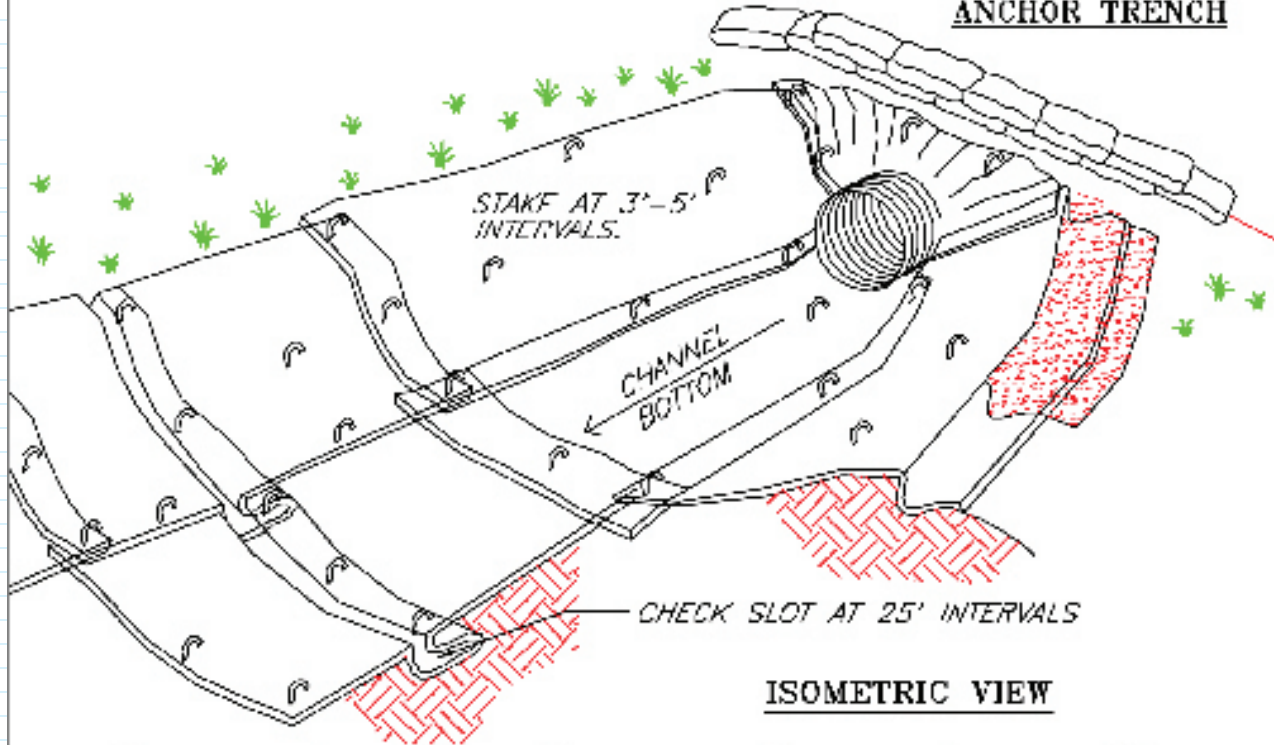

ISOMETRIC VIEW

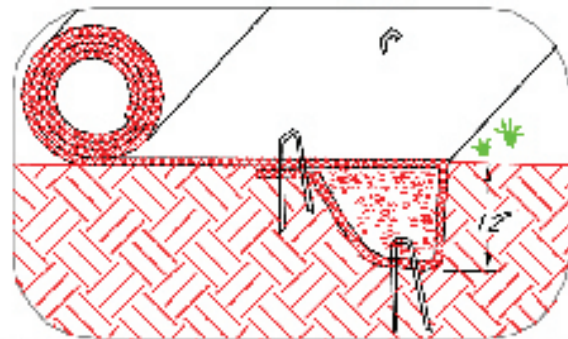

INITIAL CHANNEL ANCHOR TRENCH

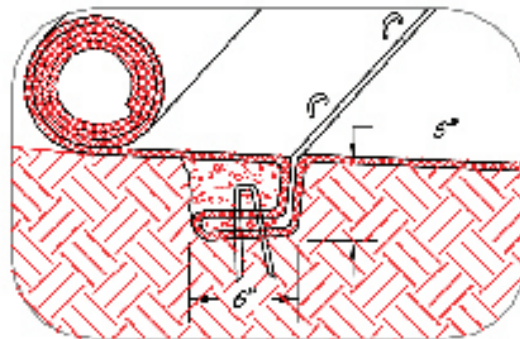

INTERMITTENT CHECK SLOT

NOTES:

1. CHECK SLOTS TO BE CONSTRUCTED PER MANUFACTURER'S SPECIFICATIONS.
2. STAKING OR STAPLING LAYOUT PER MANUFACTURER'S SPECIFICATIONS.

SOURCE: SALIX APPLIED EARTHCARE – EROSION DRAW 5.0

EROSION BLANKETS & TURF REINFORCEMENT MATS CHANNEL INSTALLATION

MATS/BLANKETS SHOULD BE INSTALLED VERTICALLY DOWNSLOPE.

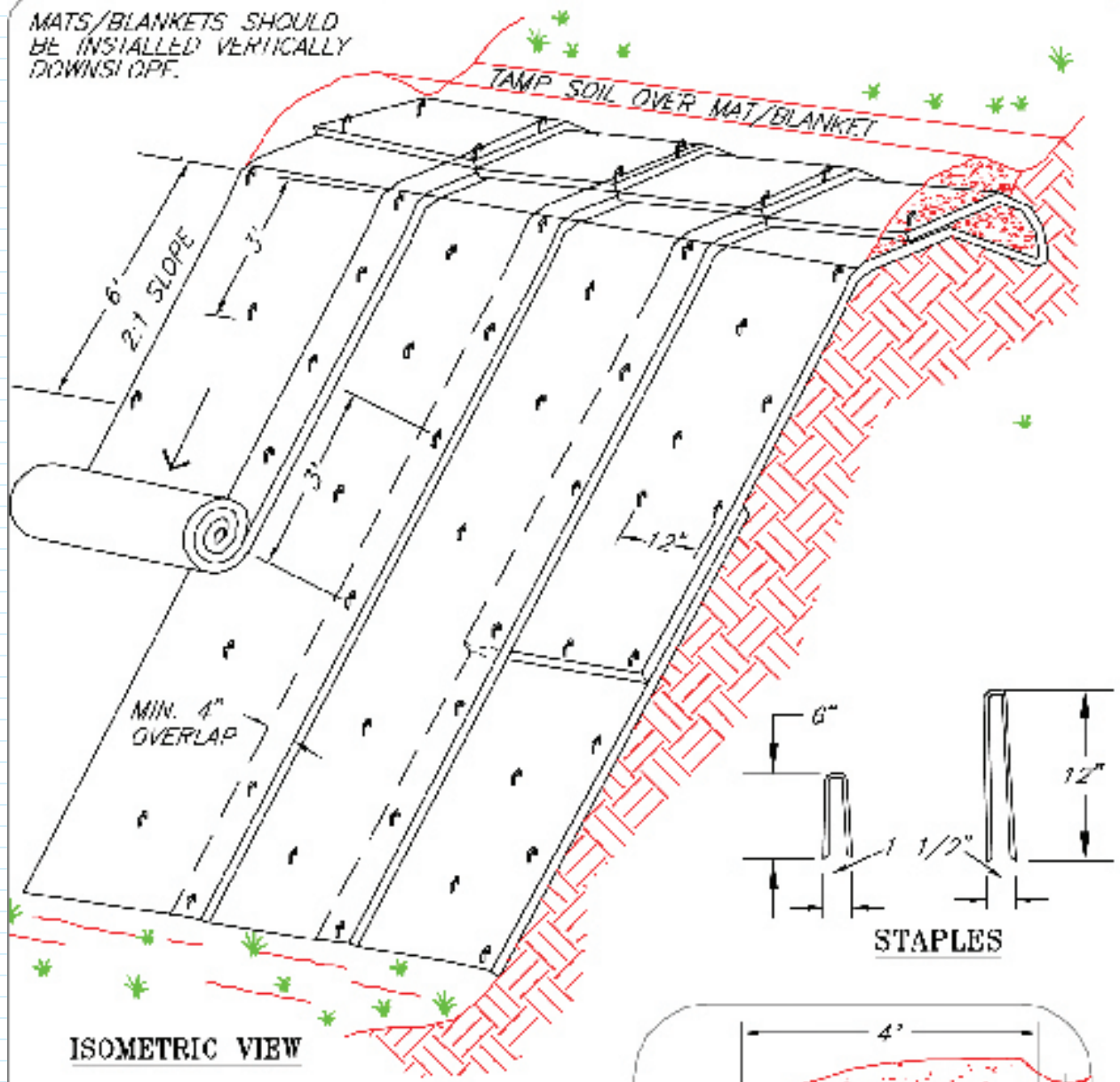

ISOMETRIC VIEW

**TYPICAL SLOPE
SOIL STABILIZATION**

NOTES:

1. SLOPE SURFACE SHALL BE FREE OF ROCKS, CLODS, STICKS AND GRASS. MATS/BLANKETS SHALL HAVE GOOD SOIL CONTACT.
2. APPLY PERMANENT SEEDING BEFORE PLACING BLANKETS.
3. LAY BLANKETS LOOSELY AND STAKE OR STAPLE TO MAINTAIN DIRECT CONTACT WITH THE SOIL. DO NOT STRETCH.

SOURCE: SALIX APPLIED EARTHCARE -
EROSION DRAW 5.0

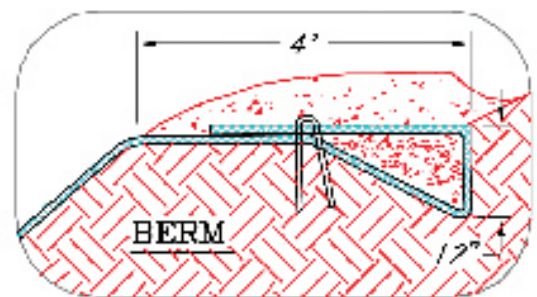

NOT TO SCALE

**EROSION BLANKETS &
TURF REINFORCEMENT MATS
SLOPE INSTALLATION**

4.5 Slope Protection

4.5.4 Temporary Slope Drains



Securely installed plastic pipe functions very well as a temporary slope drain. Inspect after rainfall to make sure flows are routed into drain pipe, and outlet areas are stable and not eroding.

Definition

A temporary slope drain is a pipe or lined (TRM, rock, or concrete) ditch or channel extending from the top to the bottom of a cut or fill slope during the construction period.

Purpose

Temporary slope drains serve to convey concentrated runoff down the face of a cut or fill slope without causing erosion. They are generally used in conjunction with diversions to convey runoff down a slope until permanent water management measures can be installed.

Design Criteria

Use the design criteria below for both pipe and channel slope drains. For channels, see the section on Channels and Ditches for information on lining temporary and permanent slope drains constructed as open conveyances.

General—It is very important that these temporary structures be sized, installed, and maintained properly, because their failure will usually result in severe erosion of the slope. The entrance section to the drain should be well entrenched, staked down, and stable so that surface water can enter freely. The drain should extend downslope beyond the toe of the slope to a stable area or appropriately stabilized outlet.

Pipe capacity—The pipe should be able to handle peak flow from the 10-year, 24-hour storm. Use 10-inch diameter or larger pipe to convey runoff from areas up to one-third acre; 12-inch or larger pipe for up to half-acre drainage areas, and 18-inch pipe for areas up to one acre. Multiple pipes or channels are often required for large areas, spaced as needed.

Conduit—Construct the slope drain pipes from heavy-duty, flexible materials such as non-perforated, corrugated plastic pipe, or open top overside drains with tapered inlets, or corrugated metal pipe (CMP). Install reinforced, hold-down grommets or stakes to anchor the conduit at intervals not to exceed 10 feet with the outlet end securely fastened in place. CMP or corrugated plastic pipe must have one anchor assembly for every 20 feet of slope drain. The conduit must extend beyond the toe of the slope.

Entrance—Construct the entrance to the slope drain of a standard flared-inlet section of pipe with a minimum 6-inch metal toe plate. Make all fittings watertight. A standard T-section fitting can also be used at the inlet. An open top flared inlet for overside drain can also be used.

Temporary diversion—Generally, use an earthen diversion with a dike ridge or berm to direct surface runoff into the temporary slope drain. Make the height of the ridge over the drain conduit a minimum of 1.5 feet and at least 6 inches higher than the adjoining ridge on either side. The lowest point of the



diversion ridge should be a minimum of 1 foot above the top of the drain so that design flow can freely enter the pipe.

Outlet protection—Protect the outlet of the slope drain from erosion with an energy dissipator. (i.e., rock apron or other armoring).

Construction Specifications

A common failure of slope drains is caused by water saturating the soil and seeping along the pipe. Proper backfilling around and under the pipe haunches with stable soil material and hand-compacting in 6 inch lifts to achieve firm contact between the pipe and the soil at all points will reduce this type of failure.

- Place slope drains on undisturbed soil or well-compacted fill at locations and elevations shown on the plans.
- Slightly slope the section of pipe under the dike toward its outlet.
- Compact the soil under and around the entrance section in lifts not to exceed 6 inches.
- Ensure that fill over the drain at the top of the slope has a minimum depth of 1.5 feet and a minimum top width of 4 feet. The sides should have a 3H:1V slope.
- Ensure that all slope drain connections are watertight.
- Ensure that all fill material is well compacted. Securely fasten the exposed section of the drain with grommets or stakes spaced no more than 10 feet apart.
- Extend the drain beyond the toe of the slope and adequately protect the outlet from erosion.
- Make the settled, compacted dike ridge no less than 1 foot higher than the top of the pipe inlet.

Immediately stabilize all disturbed areas following construction.

Inspection and Maintenance

Inspect slope drains and supporting diversions weekly and after every significant rainfall and promptly make necessary repairs. When the protected area has been permanently stabilized, temporary measures can be removed, materials disposed of properly, and all disturbed areas stabilized appropriately.



This is a very good installation of a rock-lined slope drain. Inspect weekly until site is stabilized. Use geotextile under rock to prevent undercutting.

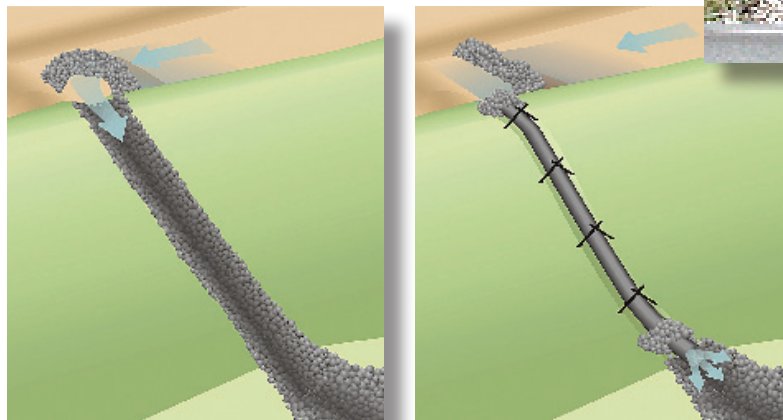

Rock-lined slope drains (left) should have a non-woven geotextile underliner, to prevent erosion and undermining. Use rock or sandbag berms to route runoff into slope drains (right). Stake down plastic pipe securely. Control outlet erosion with a flow dissipator (see Section 4.5).

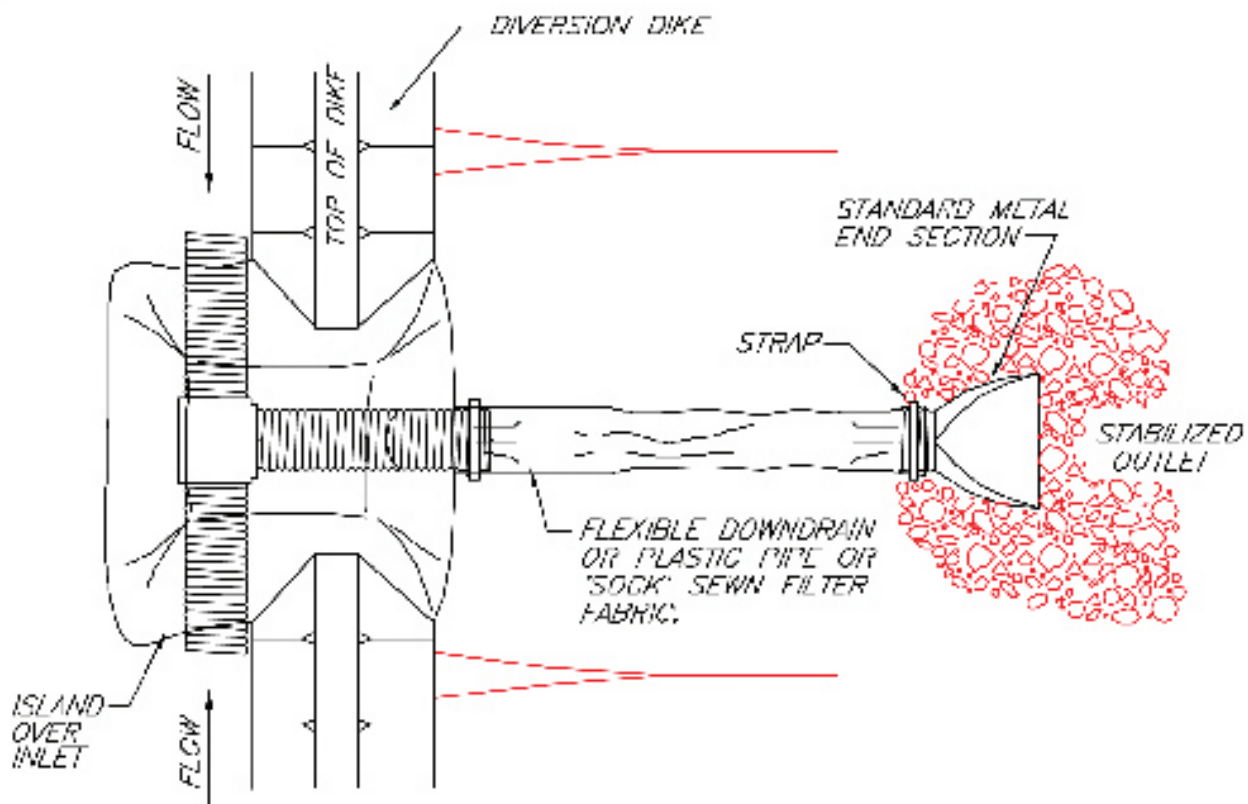

PLAN VIEW

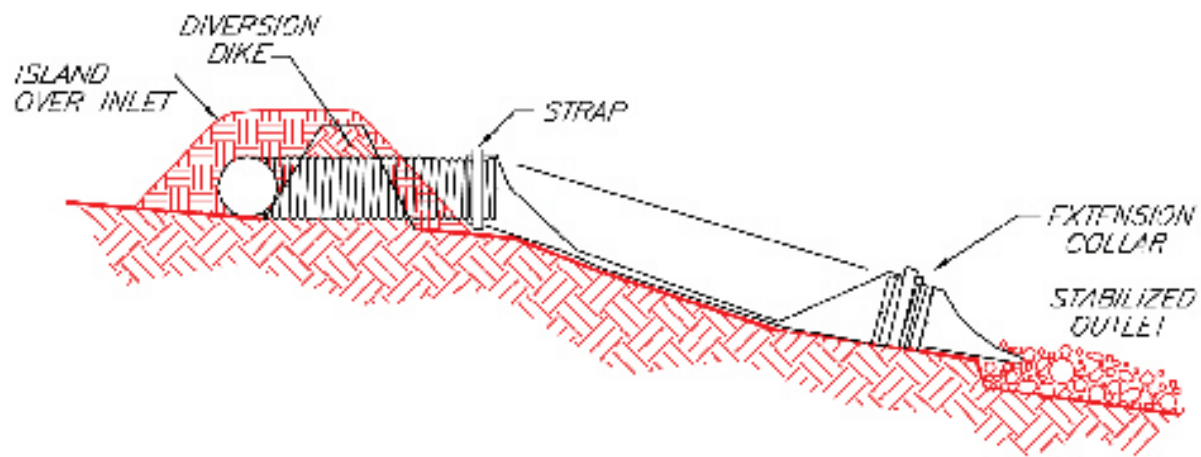

SECTION

SLOPE DRAIN

SOURCE: SALIX APPLIED EARTHCARE -
EROSION DRAW 5.0

4.5 Slope Protection

4.5.5 Gabion Baskets and Mattresses



Galvanized wire can be fabricated into box-like gabion baskets (left) or flatter mattresses. Mixing mulch and soil into gabion structures—or applying it to the surface after construction—can help establish vegetation that provides a softer look. Note that US Army Corps of Engineers Section 404 permits and KDOW floodplain permits are required when gabion structures are laced within the banks of streams, rivers, wetlands, lakes, or other regulated water bodies.



Definition

Gabions are rectangular galvanized wire baskets filled with stones used as pervious, semi-flexible building blocks for slope and channel stabilization. Mulch, soil, and live rooting branches can be placed between the rock-filled baskets to support vegetation.

Purpose

Gabions protect slopes and streambanks from the erosive forces of moving water. Rock-filled gabion baskets or mattresses can be used as retaining walls for slopes, to armor the bed or banks of channels, or to divert flow away from eroding channel sections. Rock-filled or vegetated rock gabions are used on streambank sections subject to excessive erosion because of increased flows or disturbance during construction. Gabions can be specified where flow velocities exceed 6 feet per second and where vegetative streambank protection alone is not sufficient. Gabions can be used to construct deflectors or groins intended to divert flow away from eroding streambank sections. Gabions are also used to construct retaining walls and grade control structures. Gabion walls are appropriate where

- An excessively steep stream bank must be stabilized and vegetative or extreme mechanical means of stabilization (i.e., pulling back bank) are not feasible because of site conditions.
- The vertical integrity of a soil bank needs a higher tensile strength to reduce sloughing of the streambank.
- There is moderate to excessive subsurface water movements that could be creating erosion and damaging other types of nonpermeable structures.
- The slope must be modified while heavy machinery is unavailable to the site.
- Fill must be disposed of along an eroding streambank (fill can be placed behind gabion to modify slope).
- A retaining or toe wall is needed to stabilize the slope.
- Rock riprap is an appropriate practice, but the available or desired rock size (smaller) is not sufficient alone to resist the expected shear stress exerted on the revetment. Gabions allow the use of a smaller size rock than would be possible without the wire baskets because the rock is bound by the wire mesh, creating a more monolithic structure.

Design Criteria

There are several types of gabion structures and applications useful on construction sites, as summarized below. Gabion structures are not recommended for steeply sloping channels where rock or high volumes of gravel sediment move at high velocity in the channel bed because of the possibility of damage to the wire mesh and failure of the basket or mattress structure.

Gabion wall—Basically a gravity wall that relies on its own weight and frictional resistance to resist sliding and overturning from lateral earth pressure.

Vegetated rock gabion—A rock-filled gabion earth-retaining structure that has live branches placed between each consecutive layer of rock-filled baskets. The live branches will take root inside the gabion and into the soil behind the structure. The vegetation will consolidate the structures and bind it to the slope.

Gabion deflector—Deflector or groins project into the streams and divert flows away from eroding streambank sections.

Gabion aprons—Rock-filled gabions or gabion mattress used as outlet protection, energy dissipators, or spillways. These semiflexible gabions are designed to settle without fracturing and adhere to the ground if scour occurs.

Grade control—Drop structures or weirs. Gabion baskets and mattresses can be combined to construct check dams or weirs.

Channel lining—Gabion mattresses can be used to line channels. The lining thickness depends on many factors such as the type of rock, design flow velocity, sediment and bedload, and channel gradient.

Gabion mattresses—Also referred to as Reno mattresses or revet mattresses, gabion mattresses are not as thick as gabions, usually one-half, three-quarters, or 1 foot thick. Gabion mattresses are used to line channels, armor streambanks and slopes, and used with gabions for grade-control structures (spillways or aprons).

Gabions and gabion mattresses are often preferable to rock riprap alone. For any given hydraulic condition, the gabion or gabion mattress revetment thickness is one-third of an equivalent riprap design. Gabions and gabion mattresses are flexible and free draining, thus allowing some soil settling. They can be used in unstable streambeds and streambanks. Gabions can provide an important component to a bioengineering solution for streambank or slope erosion because they allow the growth and establishment of natural vegetation.

Gabion containers are generally fabricated from a double-twist, hexagonal mesh of heavily zinc-coated wire. Some gabions use welded wire. As an option, the wire can be coated with PVC. Wire diameter is 0.086 inches for the double-twisted gabion mattress and 0.106–0.120 inches for the double-twisted gabion. The welded wire gabion uses wire diameters of 0.120 inches or greater. The rectangular gabions are divided into cells with diaphragms of equal capacity. The compartments add strength and assure that the full material remains evenly distributed. Gabions and gabion mattresses come in various sizes.

Choose the dimensions of the gabions or combination of gabions to meet the design requirement site conditions. The mesh opening for gabions is typically or nominally 3.25 x 4.5 inches. Some gabion mattresses have mesh openings of approximately 2.5 x 3.25 inches. Both styles perform hydraulically equivalent.

The use of gabion structures in urban areas may be restricted, because of the possibility that they will harbor rodents and other pests. Some counties and cities in Kentucky have banned gabion structures except in extreme conditions, where no other material is appropriate.

Typical Gabion Basket Sizes

| Letter Code | Length (ft) | Width (ft) | Depth (ft) | Number of Cells | Capacity (cubic yards) |
|-------------|-------------|------------|------------|-----------------|------------------------|
| A | 6 | 3 | 3 | 1 | 2 |
| B | 9 | 3 | 3 | 2 | 3 |
| C | 12 | 3 | 3 | 3 | 4 |
| D | 6 | 3 | 1.5 | 1 | 1 |
| E | 9 | 3 | 1.5 | 2 | 1.5 |
| F | 12 | 3 | 1.5 | 3 | 2 |
| G | 6 | 3 | 1 | 1 | 0.666 |
| H | 9 | 3 | 1 | 2 | 1 |
| I | 12 | 3 | 1 | 3 | 1.333 |
| T | 9 | 6 | .75 | 3 | 2.0 |
| U | 12 | 6 | .75 | 4 | 1.33 |
| Q | 9 | 6 | .5 | 3 | 1.33 |
| S | 9 | 6 | .5 | 2 | 1.0 |

Construction Specifications

Install gabions in accordance with manufacturer's standards and specifications.

- Gabions must be fabricated so that the sides, ends, lid and diaphragms can be assembled at the construction site into rectangular baskets of the sizes specified and shown on the construction drawings.
- Gabions must be of single-unit construction; the base, lid, ends and sides must be either woven into a single unit or one edge of these members connected to the base section of the gabion so that the strength and flexibility at the connecting point is at least equal to that of the mesh.
- Where the length of the gabion exceeds 1.5 times its horizontal width, the gabion must be divided by diaphragms of the same mesh and gauge as the body of the gabion, into cells whose length does not exceed the horizontal width.
- Gabions and mattresses are unfolded and assembled at the job site. Corners are first joined together and then the diaphragms are attached to the side panels.
- Each gabion must be assembled by tying all untied edges with lacing wire or approved fasteners. The lacing wire must be tightly looped around every other mesh opening along the seams so that single and double loops are alternated.
- The gabion or gabion mattress must be securely keyed into the streambank or streambed to assure that flows do not erode the soils beneath or around it.
- Starting at the lowest point of the slope, excavate the loose material 2–3 feet below the ground elevation until a stable foundation is reached.
- Excavate the back of the stable foundation slightly deeper than the front so the foundation tilts back into the slope.
- A line of empty gabion units must be placed in the bottom of its excavation and the baskets are to be joined together along adjacent edges, both horizontally and vertically. The base of the empty gabions placed on top of a filled line of gabions must be tightly wired to the latter at front and back.

- To achieve better alignment and finish in gabion walls, stretching of the gabions is recommended.
- For gabions greater than 18 inches, connecting wires (wires tied to opposite faces of each gabion cell) must be installed during filling operations.
- Hand-packing the gabion baskets or mattresses is preferred, but mechanical filling is acceptable if care is taken to avoid bending, distorting, or damaging the wire structures. Gabions must be filled to a depth of 12 inches and then two connecting wires must be tightly tied to opposite faces of each gabion cell at a height of 12 inches above the base. Gabions must then be filled with a further depth of 12 inches and two connecting wires must be similarly tied at this level. Then gabions must be filled to the top.
- Fill gabions with appropriately sized river rock or quarry stone or other approved infill material. Use of hard material with high specific gravity is recommended. The tops of the gabions are then closed along edges and diaphragms using lacing wire or approved fasteners. Keep voids and bulges in the gabions to a minimum to ensure proper alignment and a neat, compact, square appearance.
- The stone size to fill gabions must be 3–5 inches for gabion mattresses and 4–8 inches for gabion baskets.

Inspection and Maintenance

Inspection of construction methods during the gabion assembly, placement, and fill process will help ensure that the structure performs as intended. All structures should be maintained in an *as built* condition. Structural damage caused by storm events should be repaired as soon as possible to prevent further damage to the structure or erosion of the streambank.

During inspection, look for undercutting, bypassing, or other flow-related erosion problems. Check to ensure that basket wiring is adequate, and components are not separating (i.e., sidewalls becoming detached). Repair baskets that appear to be splitting; use rock or other armoring to repair eroded areas.



Gabion mattresses can replace turf mats in high-flow, high-velocity channels. Mixing mulch and soil into the rock can help support vegetation for a “greener” look.



Gabions can protect banks in areas of high velocity flows. Some designers prefer TRMs in these situations, if space is available to slope banks back appropriately.

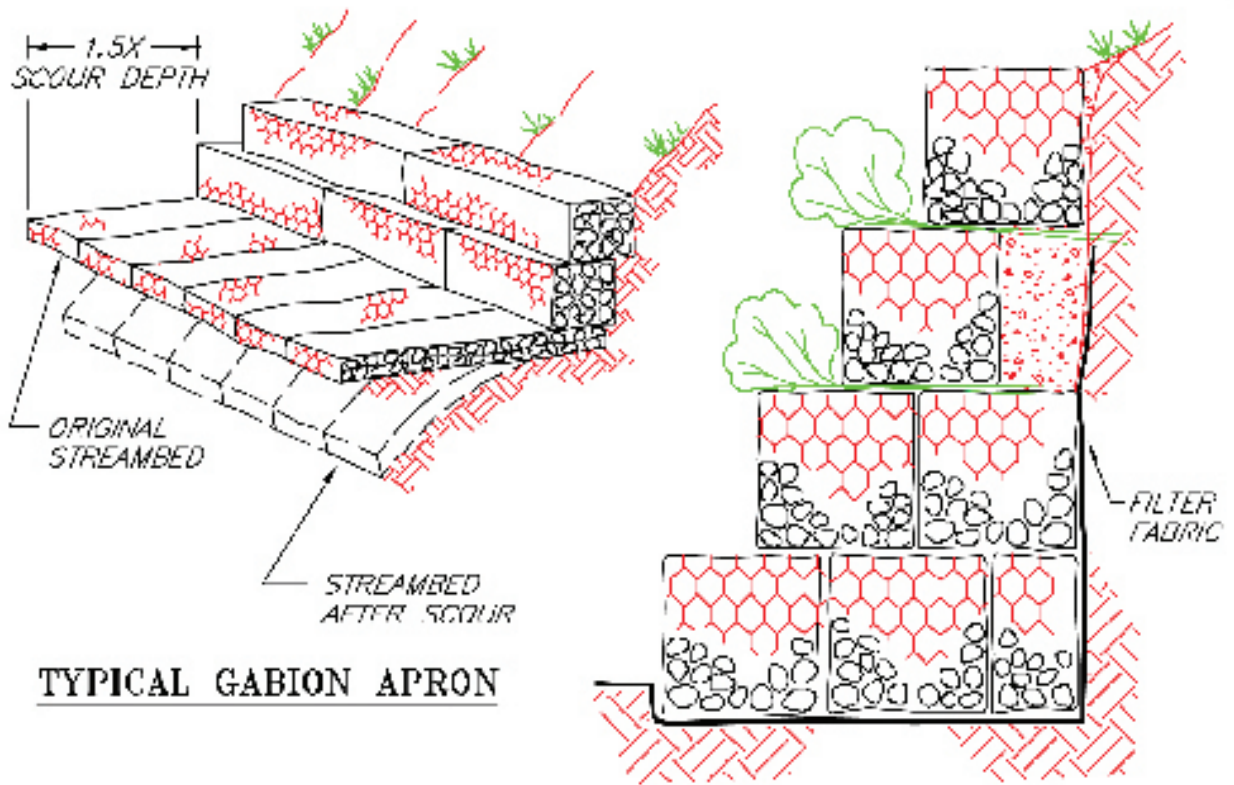

TYPICAL GABION APRON

TYPICAL VEGETATED ROCK GABION

TYPICAL GABION AND GABION MATTRESS

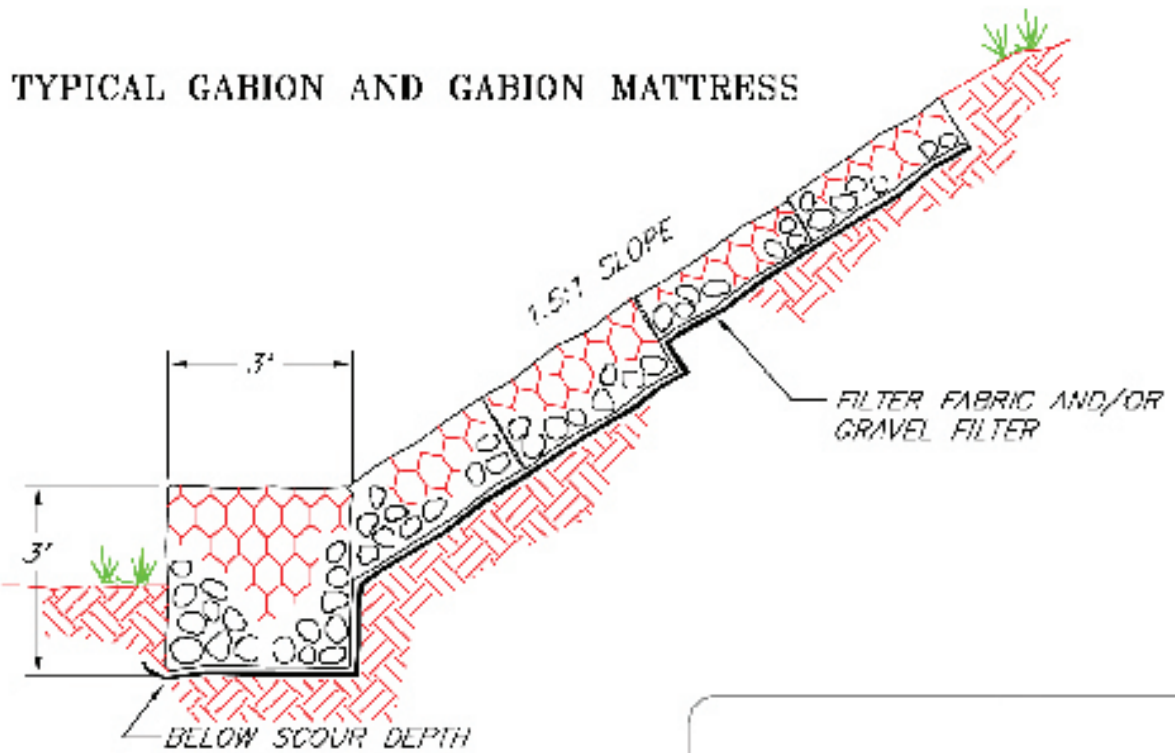

GABIONS

SOURCE: SALIX APPLIED EARTHCARE -
EROSION DRAW 5.0

4.5 Slope Protection

4.5.6 Cellular Confinement Systems



Concrete and plastic cellular blankets, like this open-celled concrete block product, provide heavy armoring while supporting vegetation that softens the final look.

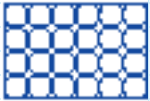

Definition

A cellular confinement system (CCS) is a three-dimensional, honeycombed, sheet, mat, or interlocking structure filled with soil and planted with vegetation used to stabilize the surface of earthen cut and fill slopes.

Purpose

CCSs are permanent erosion control practices intended to stabilize infill materials for slope and channel protection, load support, and earth retention applications. The expandable panels create a cellular system that confines topsoil infill, protects and reinforces the plant's root zone, and permits infiltration and natural subsurface drainage. The honeycomb shaped cells encapsulate and prevent erosion of the infill material. The cellular confinement systems are used for

- **Revetments**—Filling the cells with topsoil or rock and vegetation can provide an alternative to hard armor revetment systems
- **Erosion control on steep slopes**—Cells can be filled with soil and vegetated or filled with granular materials. Slopes as steep as 1H:1V can be treated with cellular confinement systems. Application on steep slopes may require tendons for system stability and security against sliding.
- **Flexible channel lining systems**—either vegetated or rock filled.
- **Road stabilization**—cells confine and reinforce select fill materials, thereby increasing load-bearing capacities. Creates a porous pavement system with aggregate or topsoil/vegetation infill.
- **Temporary low-water stream crossings.**

Construction Specifications

Site Preparation

The surface of the slope should be leveled, with stones and debris removed. Gullies should be filled and well compacted. Major obstacles such as boulders can be left in place. Simply cut out panels around them.

Following excavation and fill placement operations, shape and compact the subgrade surfaces to the designed elevations and grades.

Excavate the area so that when cellular confinement systems are installed, the top of the section is flush with or slightly lower than the adjacent terrain or final grade.

Remove unstable subgrade soils when required and install geotextile underliner if specified.

Installation

Follow manufacturer's instructions regarding application type, slope limits, installation procedure, appropriate fill material, and so on.

- Anchor the cellular confinement system sections at the top of the slope across a 2–4 foot ledge. Expand and stretch the cellular confinement system down the slopes.
- The type of anchors and frequency of anchoring will depend on site conditions. Typically, every other cell across the top section is anchored with J-pins or other suitable anchor devices. This anchoring pattern is repeated every 6 feet down the slope.
- The cells should be anchored securely to prevent deformation of the panel while backfilling. Depending on the slope angle and fill soils involved, intermediate anchorage will be necessary on some interior cells to limit sideways deformation, ensure stability and avoid overloading the upper sections.
- Additional panels are abutted together and joined with staples, hog rings or other suitable fasteners.

Infill Placement

Place the fill material in the expanded cells with suitable equipment such as a backhoe, front-end loader or conveyor.

- Limit drop height to 3 feet to reduce crushing force on cell material.
- On steep slopes, infill from the crest to the toe to prevent displacement and deformation of the cellular confinement system.
- Overfilling and compacting of infill depend on the type and consistency of material and the depth of the cells.

Inspection and Maintenance

Inspect slope periodically and after significant rainstorms to check for erosion. Any failure should be repaired immediately.

If vegetation has not been established, fertilize and reseed damaged and sparse areas immediately.



Cellular concrete mat used to stabilize banks in a highly erodible silty loam soil. Double- or triple-seed these applications immediately after installation. Mulch might be needed to support seeded areas until grass is established.

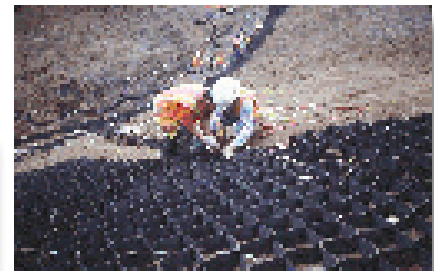

Plastic cellular blanket installed on a steep, long slope. Work closely with manufacturers on these applications to ensure proper design, installation, and initial maintenance.



Cellular blankets provide an aesthetic alternative to poured concrete walls and other armored installations

4.6 Drainage System Controls

General Information

Construction site ditches, curb inlets, drop inlets, inlets to culverts, and other areas where muddy runoff flows toward the stormwater conveyance system need to be protected. Ditches are protected with a variety of liners: sod, grass-seeded turf reinforcement mats, riprap, gabions, pavement, or other material as appropriate. The long-term management of ditches and channels as stable, vegetated, *natural* drainage systems with native vegetation buffers is highly recommended because of the inherent stability offered by grasses, shrubs, trees, and other vegetation; greater visual and other aesthetic benefits provided by native plant buffers; and higher habitat and property values.

Ditches and Channels

During the construction phase, ditches and channels with gently sloping bottoms (less than 3 percent) can be stabilized with thick grass seedings and erosion control blankets. Moderately sloping channels (3–6 percent slopes) will likely require seed and TRMs and perhaps riprap if soils have high silt content. Steeply sloping channels (greater than 10 percent) need heavier armoring with concrete, riprap, gabions, geogrid, grade control structures, or other measures.

Silty soils are the most erodible, and clay is the least erodible. Steeper ditches and channels and those with highly erodible soils need more protection. Ditch or channel bank slopes should not exceed 2:1. If tractor mowers or other equipment will cross channels in the future, bank slopes should be 3:1 or flatter. Ditches and channels must be constructed and stabilized as soon as possible or before the channel receives incoming flows.

Culvert Inlets and Outlets

The basic approach for inlet protection is to create or install a structure that ponds or filters the flow, which facilitates sediment removal through settling or physical filtration. Outlet protection involves erosion prevention in the receiving ditch, channel, pond, or other area so that high-flow scour forces can be dissipated before localized erosion occurs.

A wide variety of ditch protection and ponding or filtration products have been developed for construction site applications. These products can provide excellent performance if used correctly, but often they are installed improperly, not maintained, or otherwise misused. Following the manufacturer's instructions is essential when using commercial products.

The following sections describe both rock and commercial ditch, inlet, and outlet protection approaches and devices. Rock of various sizes (see table below) is often used to stabilize ditches, construct inlet ponding dams, and armor pipe outlets to dissipate erosive flows. Commercial products are also gaining in popularity, and some (e.g., gravel-filled bags, commercial sediment dams, filter bags) can often be reused, if care is taken to protect them from vehicles and equipment during construction.



Good construction of drainage ditch, with riprap liner for steeply sloping section (background) and erosion control blanket over triple-seeding in flatter area. Ditches should be stabilized or seeded and mulched immediately after construction.

General Stabilization Approaches for Ditches and Channels

| Channel Slope | Soil Type along Banks | | |
|------------------|---|---|--|
| | Sandy | Silty | Clays |
| Steep > 10% | Pavement, gabions, or riprap with non-woven filter fabric | Pavement, gabions, or riprap with non-woven filter fabric | Riprap with non-woven filter fabric or gabions |
| Moderate ~ 10% | Riprap with non-woven filter fabric or gabions | Riprap or cellular geogrid or TRMs & seeding | Riprap or cellular geogrid or TRMs & seeding |
| Slight ~ 5% | Riprap or TRMs & seeding | Seeding & TRMs | Seeding & TRMs |
| Mostly Flat < 3% | Seeding & ECBs | Seeding & mulching | Seeding & mulching |

Rock Sizing and Weight Information

| KYTC coarse aggregate sizing | |
|--------------------------------|--|
| Aggregate Size (KYTC Size No.) | Mean Spherical Diameter (d50) (inches) |
| 1 | 3.5 |
| 2 | 2.5 |
| 23 | 2.5 |
| 3 | 2.0 |
| 357 | 2.0 |
| 4 | 1.5 |
| 467 | 1.5 |
| 5 | 1.0 |
| 57 | 1.0 |
| 610 | 1.0 |
| 67 | 0.75 |
| 68 | 0.75 |
| 710 | 0.75 |
| 78 | 0.50 |
| 8 | 0.375 |



This is a good example of a rock-lined ditch for conveying high velocity flows. Ditch was lined with rock after construction; surrounding areas should be seeded and mulched as quickly as possible to eliminate opportunities for sediment runoff. Use geotextile under rock to prevent undercutting.

4.6 Drainage System Controls

4.6.1 Curb Inlet Sediment Barrier



Rock bags of netting material provide excellent curb inlet support, and are easy to fabricate, handle, and reuse. Avoid fabric-covered plastic piping and other products that do not adequately pond, detain, and settle incoming storm flows.



Definition

Curb inlet sediment barriers are temporary dikes or barriers constructed from concrete block, gravel, gravel-filled fiber bags, filter fabric, or other material.

Purpose

Curb inlet sediment barriers are intended to reduce the sediment discharged into storm drains by ponding the runoff and allowing the sediment to settle out. The structures allow for overflow from high runoff events, and the gravel allows the area to dewater rapidly. Some proprietary curb inlet protection devices feature a frame that supports a geotextile that promotes physical filtration of sediment in muddy runoff. Most devices—proprietary or constructed on-site—will function appropriately if assembled and placed properly.

All inlet dams and filters are intended to provide temporary treatment (i.e., until the upslope catchment area is vegetated or otherwise stabilized). A feature in using inlet protection devices is to minimize the length of time they are needed by getting the upstream area to final grade and seeding and mulching as soon as possible.

Design Criteria

There is no formal design, though SWPPP notes should specify that dikes or filters intercept all muddy flows toward the inlet without bypasses. The sediment barriers can be used at curb inlets on gently sloping, paved streets where

- Water can pond and allow sediment to separate out of suspension
- Runoff is relatively low, less than 0.5 cubic feet per second

Once the small catchment areas behind the fiber bags or block and gravel fill with sediment, future sediment-laden runoff will enter the storm drain without being treated. Therefore, sediment must be removed from these structures after each storm. Additional storage can be obtained by constructing a series of sandbag barriers along the gutter so that each barrier traps small amounts of sediment.

Construction Specifications

General

Place the barriers on gently sloping streets where water can pond. Note that devices placed in the roadway or that cause ponding on roads open to traffic could present a safety hazard; if this will be a problem, use filters with frames that lay against the curb, drop inlet filter bags, or other low-profile devices.

The barriers must allow for overflow from a severe storm event. Slope runoff must be allowed to flow over blocks and gravel and not be bypassed over the curb. A spillway must be constructed with dike structures to allow overflow.

If using fiber bags filled with gravel, the bag should be of woven-type geotextile fabric because burlap bags deteriorate rapidly. The bags must be filled with three-quarter inch drain rock or one-quarter inch pea gravel. Fill fiber bags just over halfway so they can be packed tightly together without large gaps.

The fiber bags must be placed in a curved row from the top of curb at least 3 feet into the street. The row should be curved at the ends, pointing uphill, and be tied into the curbing to prevent bypasses. Several layers of bags should be overlapped and packed tightly. Leave a one-sandbag gap in the top row to act as a spillway.

Block and Gravel Type Barriers

Place two concrete blocks on their sides perpendicular to the curb at either end of the inlet opening. These will serve as spacer blocks.

Place concrete blocks on their sides across the front of the inlet and abutting the spacer blocks. The openings in the blocks should face outward, not upward.

Cut a 2 by 4 inch stud the length of the curb inlet plus the width of the two spacer blocks. Place the stud through the outer hole of each spacer block to help keep the front blocks in place.

Place wire mesh over the outside vertical face (open ends) of the concrete blocks to prevent stone from being washed through the blocks. Use chicken wire, hardware cloth with half inch openings, or filter fabric.

Place three-quarter to one and a third inch gravel against the wire to the top of the barrier.

Inspection and Maintenance

Inspect and clean barrier weekly and after each rainfall greater than one-half inch, and remove sediment from behind the sandbag structure.

Immediately remove any sediment and gravel from the traveled way of roads.

Place the removed sediment where it cannot enter a storm drain, stream, or be transported off site.

If the gravel becomes clogged with sediment, carefully remove it from the inlet and either clean or replace it.



Protect inlets with commercial dike products or site-fabricated ponding berms made of rock, wire, or other material. If structures and ponding within roadway areas are a problem, use inlet filter bags or other low-profile products. For best results, require that sediment be retained on landscaped areas and not discharged into roadways or parking lots.

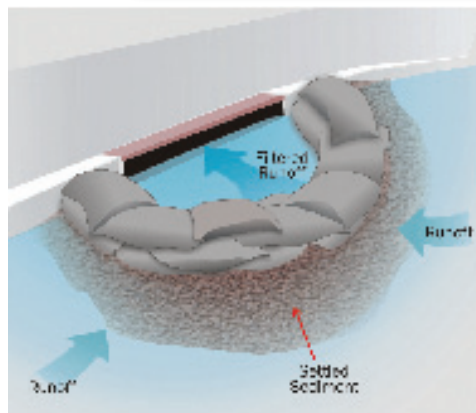

Use half-filled stone bags to create a versatile and effective ponding berm in front of inlets. Make sure there are no bypasses.

This shows poor maintenance on inlet protection device. Do not allow concrete truck washouts or other discharges into the storm sewer system—this is a direct violation of the KPDES stormwater permit!



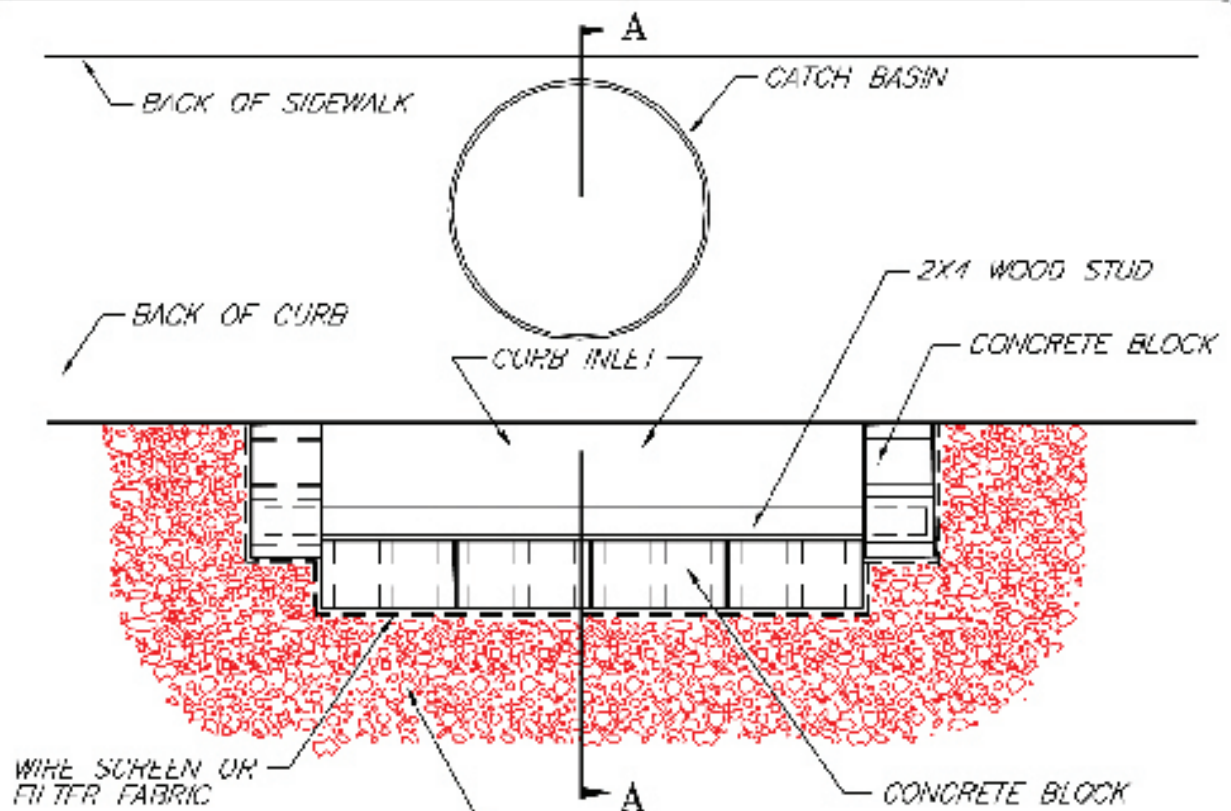

PLAN VIEW

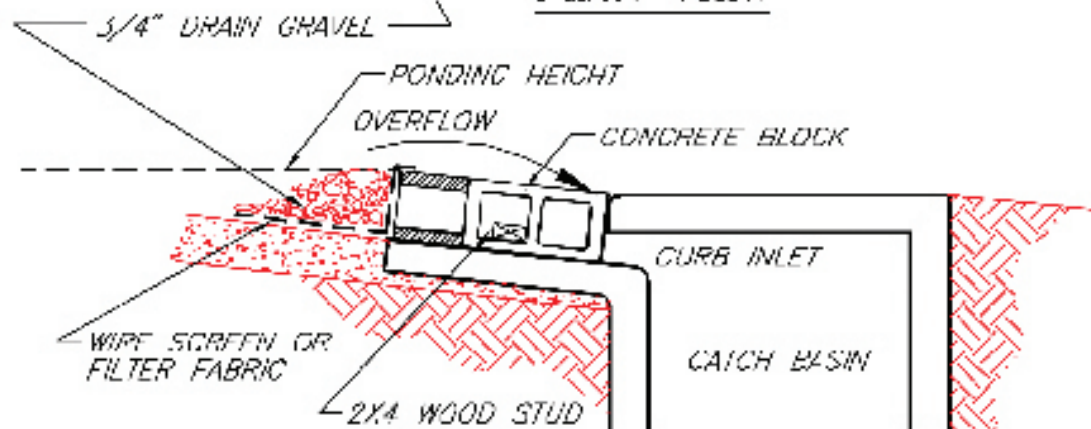

SECTION A - A

NOTES:

1. USE BLOCK AND GRAVEL TYPE SEDIMENT BARRIER WHEN CURB INLET IS LOCATED IN GENTLY SLOPING STREET SEGMENT, WHERE WATER CAN POND AND ALLOW SEDIMENT TO SEPARATE FROM RUNOFF.
2. BARRIER SHALL ALLOW FOR OVERFLOW FROM SEVERE STORM EVENT.
3. INSPECT BARRIERS AND REMOVE SEDIMENT AFTER EACH STORM EVENT. SEDIMENT AND GRAVEL MUST BE REMOVED FROM THE TRAVELED WAY IMMEDIATELY.

SOURCE: SALIX APPLIED EARTHCARE -
EROSION DRAW 5.0

**CURB INLET
SEDIMENT BARRIER
(BLOCK & GRAVEL)**

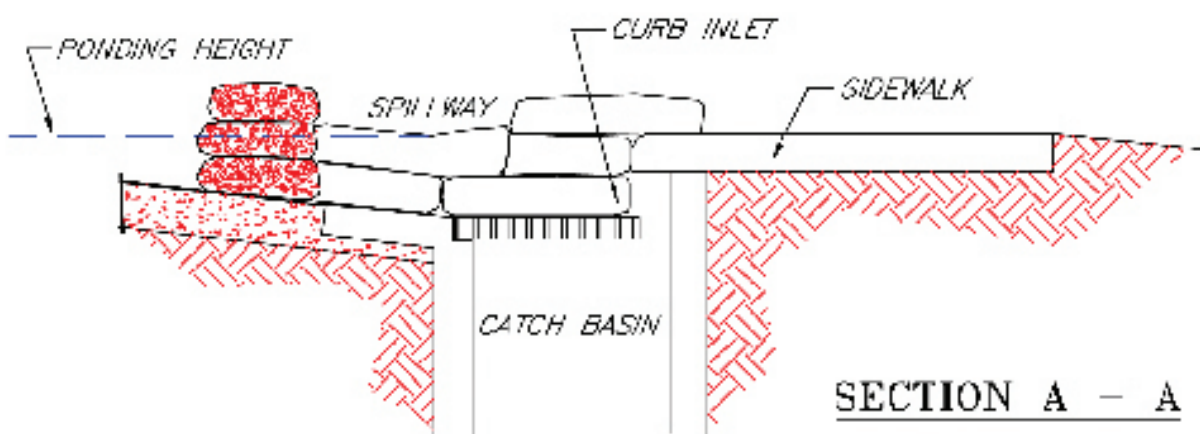
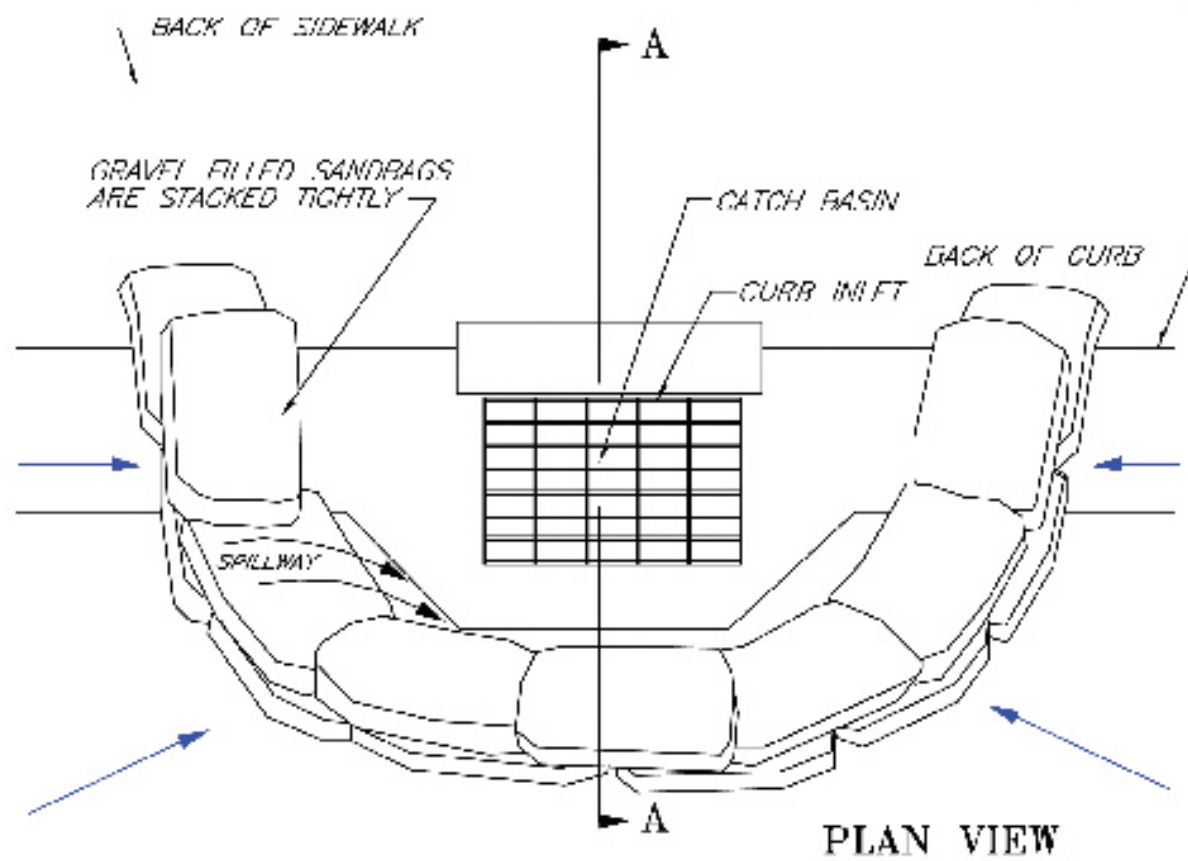

NOTES:

1. PLACE CURB TYPE SEDIMENT BARRIERS ON GENTLY SLOPING STREET SEGMENTS WHERE WATER CAN POND AND ALLOW SEDIMENT TO SEPARATE FROM RUNOFF.
2. SANDBAGS, OF EITHER BURLAP OR WOVEN GEOTEXTILE FABRIC, ARE FILLED HALFWAY WITH GRAVEL, LAYERED AND PACKED TIGHTLY. NETTING BAGS CAN BE USED WITH BALLAST ROCK.
3. LEAVE ONE SANDBAG GAP IN THE TOP ROW TO PROVIDE A SPILLWAY FOR OVERFLOW.
4. INSPECT BARRIERS AND REMOVE SEDIMENT AFTER EACH STORM. SEDIMENT MUST BE REMOVED FROM ROADS IMMEDIATELY.

SOURCE: SALIX APPLIED EARTH CARE — EROSION DRAIN 5.0

**CURB INLET
SEDIMENT BARRIER
(SANDBAGS)**

4.6 Drainage System Controls

4.6.2 Drop Inlet Sediment Barrier



Plastic frames covered with silt fence fabric make good drop inlet protection devices. Stake frames down securely and trench in bottom of fabric to eliminate bypasses. Remove accumulated sediment before it reaches halfway to the top of the fabric. Use inlet barriers during the construction period until upland areas are stabilized (i.e., bare areas are covered with vegetation, gravel, or structures).



Definition

A drop inlet sediment barrier is a temporary barrier placed around or inside a drop inlet that promotes ponding, settling of sediment, or physical filtration of sediment from muddy inflows. The sediment barrier can be constructed of silt fence, geotextile, gravel and stone, or block and gravel. Straw bales should not be used because of their high failure rates caused by improper placement, rotting, and structural weakness.

Purpose

Drop inlet sediment barriers are intended to prevent sediment from entering the storm drains during construction operations. This practice allows early use of the storm drain system. Sediment-laden runoff is ponded or filtered before entering the storm drain, thus allowing some sediment to fall out of suspension or be removed through physical filtration.

Design Criteria

The contributing drainage area should be one acre maximum. The ponding area must be relatively flat (less than 1 percent slope) with a sediment storage of 35 cubic yards per disturbed acre.

All incoming storm flows must be intercepted and ponded or filtered by the structure, and pass over the structure and into the storm drain without bypasses. Temporary diking around the structure might be necessary to prevent bypass flow. Material can be excavated from inside the sediment storage area for this purpose.

Drop inlet bag and frame filters are available from commercial vendors. These devices work very well if installed and maintained properly. Specify frames or filters that fit tightly around inlets and eliminate bypass opportunities. Filters can be reused if they are not damaged and washed out after prior use.

Construction Specifications

Silt Fence Sediment Barrier

Support posts for a silt fence must be steel fence posts or 2 by 4 inch wood, length 3-foot minimum, spacing 3-foot maximum, with a top frame X-brace or other support recommended.

Excavate a trench 4 inches wide and at least 8 inches deep and bury the bottom of the silt fence in the trench.

Backfill the trench with gravel or soil. Compact the backfill well.

The height of the silt fence must be a 1.5-foot maximum, measured from the top of the inlet.

Gravel Doughnut

Keep the stone slope toward the inlet at 3:1 or flatter or use concrete blocks to help prevent the stone from being washed into the drop inlet. A minimum 1-foot-wide level area set 4 inches below the drop inlet crest will add further protection against the entrance of material.

Stone on the slope toward the inlet should be 3 inches or larger for stability, and 1 inch or smaller on the slope away from the inlet to control flow rate. Mix various size stone for best results.

Wire mesh with 2-inch openings can be placed over the drain grating, but it must be inspected frequently to avoid blockage by trash. If concrete blocks are used, the openings should be covered with wire screen or filter fabric.

Inspection and Maintenance

Inspect the barrier weekly and after each rainfall greater than one-half inch, and promptly make repairs as needed.

Remove sediment after each significant rainfall (one inch in 24 hours) to provide adequate storage volume for the next rain.

Deposit the removed sediment in an area that will not contribute sediment off-site and can be permanently stabilized.

For gravel filters: If the gravel becomes clogged with sediment carefully remove it from the inlet and either clean or replace it. Close monitoring of drop-down inlet filter bags is required to ensure that they do not become overfilled.

Tap filter fabric with a wooden stake when dry to remove caked-on fines, taking care not to tear the fabric.



Inlet protection berm constructed of half-filled stone bags. Use #57 rock, overlap bags to eliminate large openings and rapid flow-through. Construction-grade bags of netting material—similar to onion bags—can also be used.

Commercial inlet frames and filters, ponding devices, and other products are often economical and effective approaches for inlet protection. Many can be cleaned and reused.



Silt fencing can be used as an inlet protection device if flow volumes and velocities are low. When using a silt fence frame to construction in inlet protection dike, add wire reinforcement and cross-bracing to prevent collapse in areas of heavy flows.



Side slot in drop inlet protected by half-round section of corrugated metal pipe with one-inch holes, held in place by stone berm. This modification can also be used on sediment basin outlet risers.

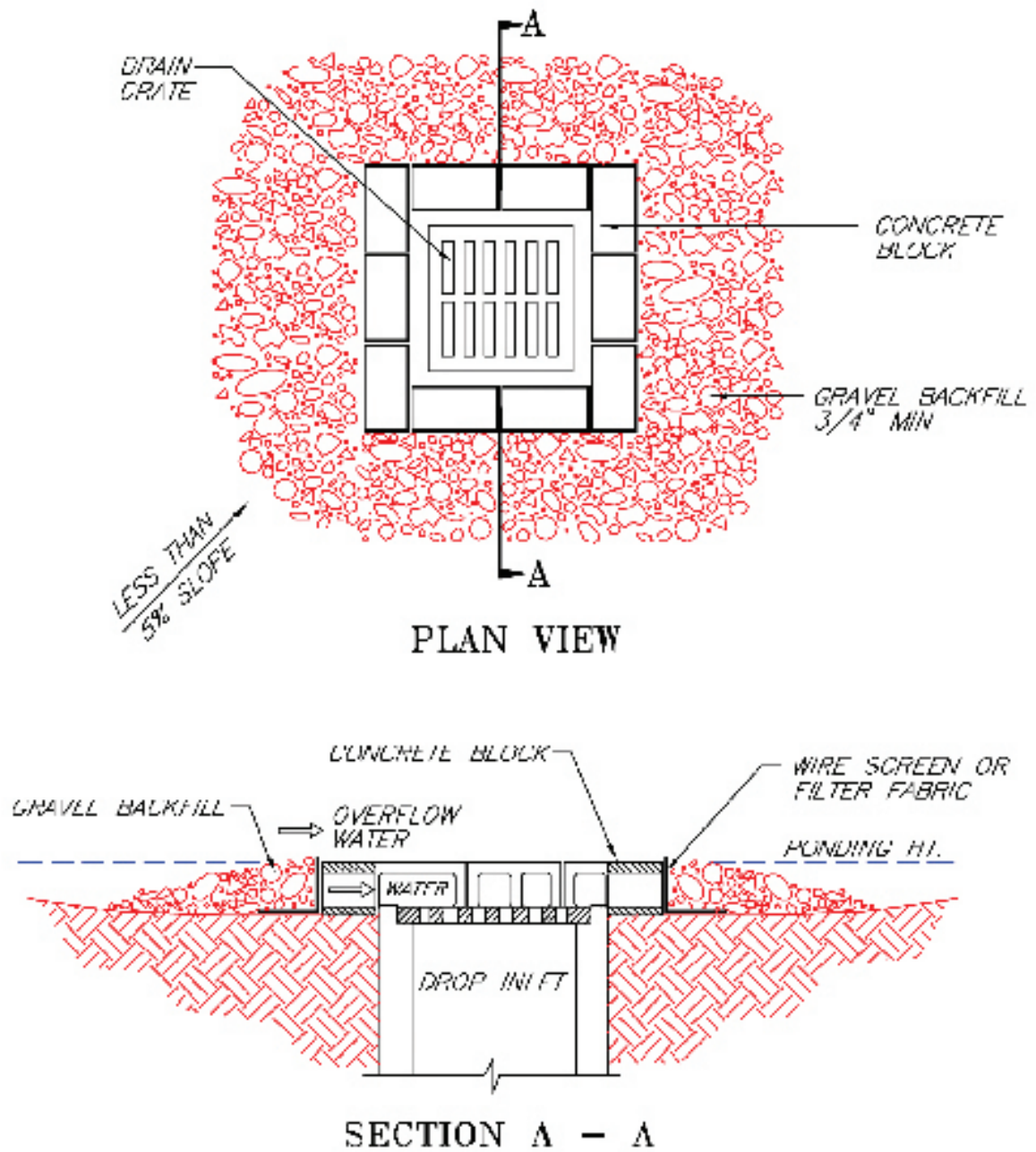

NOTES:

1. DROP INLET SEDIMENT BARRIERS ARE TO BE USED FOR SMALL, NEARLY LEVEL DRAINAGE AREAS. (LESS THAN 5%)
2. EXCAVATE A BASIN OF SUFFICIENT SIZE ADJACENT TO THE DROP INLET.
3. THE TOP OF THE STRUCTURE (PONDING HEIGHT) MUST BE WELL BELOW THE GROUND ELEVATION DOWNSLOPE TO PREVENT RUNOFF FROM BYPASSING THE INLET. A TEMPORARY DIKE MAY BE NECESSARY ON THE DOWNSLOPE SIDE OF THE STRUCTURE.

SOURCE: SALIX APPLIED EARTHCARE -
EROSION DRAW 5.0

**DROP INLET
SEDIMENT BARRIER
BLOCK AND GRAVEL**

4.6 Drainage System Controls

4.6.3 Culvert Inlet Sediment Barrier



Stone berms placed in front of culvert inlets can trap large volumes of sediment. Make sure sediment is removed as it accumulates to preserve storage capacity for the next storm.

Definition

A culvert inlet sediment barrier is a temporary rock barrier at a culvert inlet.

Purpose

The purpose of the barrier is to reduce the amount of sediment that enters the culvert by creating a small ponding area for the sediment to settle out.

Design Criteria

The barrier should surround all sides of the culvert that receives runoff and should be placed a minimum of 4 feet from the culvert. Ensure adequate ponding area for incoming flows. The barrier must be designed to ensure that no bypasses occur and that adjacent property will not be damaged by the ponded water.

Control the location of the sediment barrier spillway by placing an overflow notch at a selected location in the middle portion of the barrier. The notch should be at least six inches lower than the rest of the barrier. The downgradient portion of the overflow notch should be protected from spillover scouring with rock, turf matting, or other appropriate energy dissipator.

Construction Specifications

The stone should be KYTC Class II Channel Lining. The upstream face of the barrier should consist of smaller stone such as KYTC No. 57 to decrease the flow rate through the stone. A geotextile should be placed between the stone and the soil.

Inspection and Maintenance

The barrier should be inspected weekly and after every rainfall greater than one-half inch. The barrier must be kept free of trash and debris, and sediment should be removed when it reaches one-half the height of the barrier. The barrier should be removed after the disturbed area has been stabilized.



This is a good example of using smaller stone to face off ponding berm built of larger stone. The small rock ensures long ponding times, which maximizes sediment settling and removal.

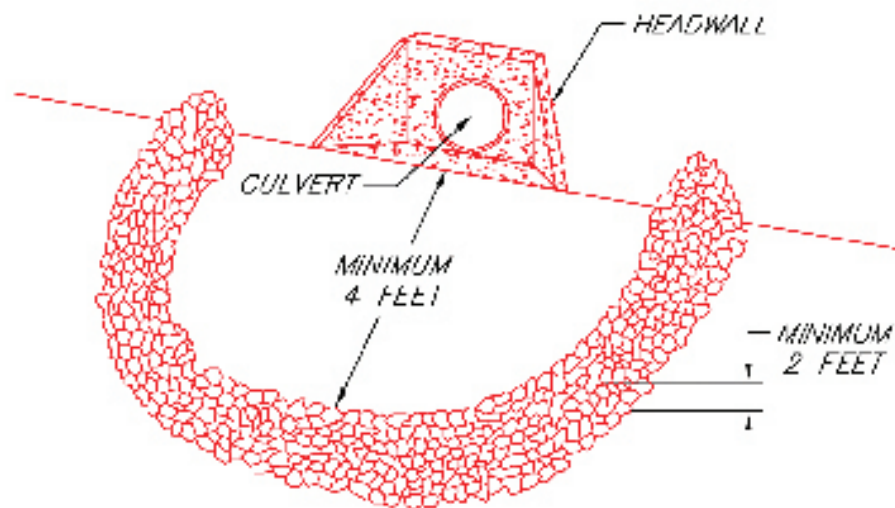
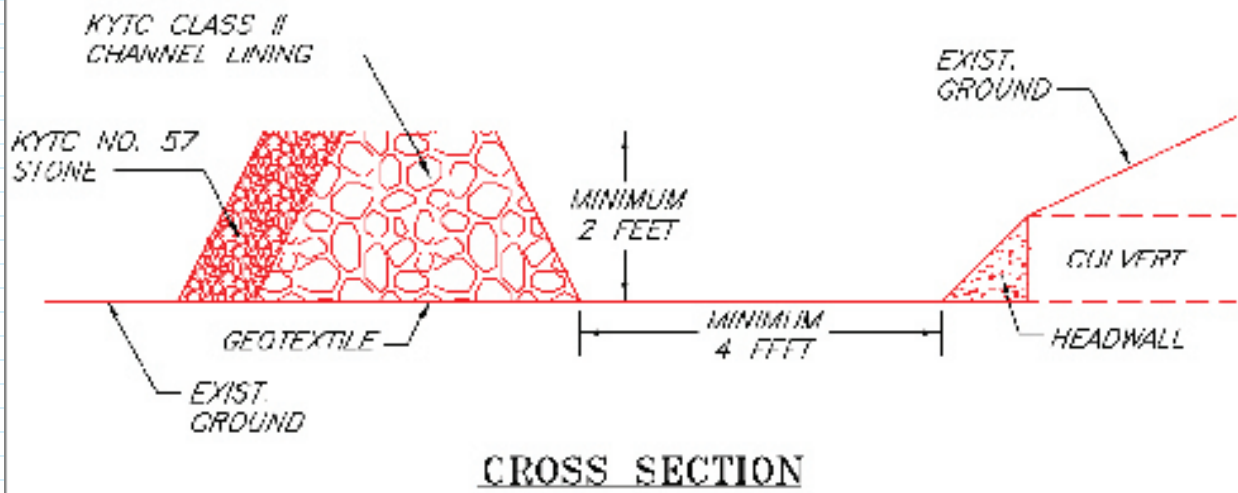

**CULVERT INLET
SEDIMENT
BARRIER**

4.6.4 Culvert Outlet Energy Dissipator



Surging flows from culverts can erode large amounts of sediment from ditches and sidewalls near outlets. Rock, well-vegetated TRMs, or cellular products can be used to reduce scour erosion at outlets.

Definition

An energy dissipator is a rock, gabion, mat, or other structure designed to control erosion at the outlet of a channel or stormwater conveyance pipe.

Purpose

Energy dissipators are used to prevent erosion at the outlet of a channel or pipe by reducing the velocity of flow and dissipating the energy before discharge into the rest of the receiving channel or area. Applications include outlets of culverts, temporary slope drains, where lined ditches discharge into unlined ditches, and outlet or overflow areas for sediment traps and basins.

Design Criteria

Design considerations are the volume and velocity of flow to be controlled, characteristics of the bank or other area receiving the brunt of the flow, and the slope of the receiving channel or area, all of which will define the shape and structure of the energy dissipator. Dissipators designed for high-energy flows are usually rock aprons; those handling smaller flows with lesser velocities can consist of TRMs if shear and other stresses can be accommodated by the chosen product. The following criteria are key to dissipator design analysis:

Capacity—Design dissipators to handle the 10-year, 24-hour peak flow event

Tailwater Depth—Determine the depth of the tailwater immediately below the pipe outlet based on the design discharge plus other contributing flows. If the tailwater depth is less than half the diameter of the outlet pipe and the receiving stream is sufficiently wide to accept the divergence of flow, it is classified as a minimum tailwater condition. If the tailwater depth is greater than half the pipe diameter, it is classified as a maximum tailwater condition. Pipes that outlet onto broad flat areas with no defined channel may be assumed to have a minimum tailwater condition unless site conditions indicate otherwise.

Apron size—See the table below.

Grade—There should be no overfall at the end of the apron; that is, the elevation of the top of the apron at the downstream end should be the same as the elevation of the bottom of the receiving channel or the adjacent ground if there is no channel.

Alignment—The apron should be straight throughout its entire length, but if a curve is necessary to align the apron with the receiving stream, locate the curve in the upstream section of riprap. Additional armoring of the outside portion of the curve receiving the greatest scouring flows might be needed.



Materials—Ensure that riprap consists of a well-graded mixture of stone. Larger stone should predominate, with sufficient smaller sizes to fill the voids between the stones. The diameter of the largest stone size should be no greater than 1.5 times the d50 size.

Thickness—The minimum thickness of riprap must be 1.5 times the maximum stone diameter.

Stone quality—Select stone for riprap from fieldstone or quarry stone. The stone should be hard, angular, and highly weather-resistant. The specific gravity of the individual stones should be at least 2.5.

Filter—Install a non-woven geotextile liner (filter) under the rock to prevent soil movement through the openings in the riprap. Geotextile underliners for rock outlet energy dissipators are highly recommended to prevent erosion and undermining of the dissipator. Specify non-woven fabric tailored to the strength needed to support the rock load.

Construction Specifications

Ensure that the subgrade for the underliner and riprap follows the required lines and grades shown in the plan. Compact any fill required in the subgrade to the density of the surrounding undisturbed material. Low areas in the subgrade on undisturbed soil can also be filled by increasing the riprap thickness.

- The riprap and gravel underliner must conform to the specified grading limits shown on the plans.
- Filter (non-woven geotextile) cloth, when used, must meet design requirements and be properly protected from punching or tearing during installation. Repair any damaged fabric by removing the riprap and placing another piece of filter cloth over the damaged area. All connecting joints should overlap a minimum of 1 foot. If the damage is extensive, replace the entire filter cloth.
- Riprap can be placed by equipment, but take care to avoid damaging the filter.
- The minimum thickness of the riprap should be 1.5 times the maximum stone diameter.
- Riprap may be field stone or rough quarry stone. It should be hard, angular, highly weather-resistant and well graded.
- Construct the apron with no overfall at the end. Make the top of the riprap at the downstream end level with the receiving area or slightly below it.
- Ensure that the apron is properly aligned with the receiving stream and preferably straight throughout its length. If a curve is needed to fit site conditions, place it in the upper section of the apron.
- Immediately after construction, stabilize all disturbed areas with vegetation.

Inspection and Maintenance

Inspect riprap outlet structures weekly and after every rainfall greater than one-half inch to see if any erosion around or below the riprap has taken place or if stones have been dislodged. Immediately make all needed repairs to prevent further damage.

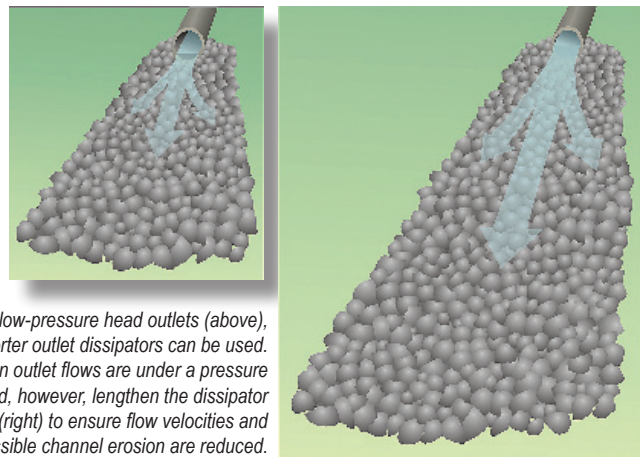

For low-pressure head outlets (above), shorter outlet dissipators can be used. When outlet flows are under a pressure head, however, lengthen the dissipator (right) to ensure flow velocities and possible channel erosion are reduced.

Table of Riprap Apron Dimensions

The tables below can be used to determine the length, width, and D50 stone size of a riprap apron based on circular culverts flowing full.

Riprap Aprons for Low Tailwater (downstream flow depth < 0.5 x pipe diameter)

| Culvert Diameter | Lowest Value | | | Intermediate Values to Interpolate From | | | | | | | | | Highest Value | | |
|------------------|--------------|----------------|-----------------|---|----------------|-----------------|-----|----------------|-----------------|-----|----------------|-----------------|---------------|----------------|-----------------|
| | Q | L _A | D ₅₀ | Q | L _A | D ₅₀ | Q | L _A | D ₅₀ | Q | L _A | D ₅₀ | Q | L _A | D ₅₀ |
| | Cfs | Ft | In | Cfs | Ft | In | Cfs | Ft | In | Cfs | Ft | In | Cfs | Ft | In |
| 12" | 4 | 7 | 6 | 6 | 10 | 6 | 9 | 13 | 6 | 12 | 16 | 7 | 14 | 17 | 8.5 |
| 15" | 6.5 | 8 | 6 | 10 | 12 | 6 | 15 | 16 | 7 | 20 | 18 | 10 | 25 | 20 | 12 |
| 18" | 10 | 9 | 6 | 15 | 14 | 6 | 20 | 17 | 7 | 30 | 22 | 11 | 40 | 25 | 14 |
| 21" | 15 | 11 | 6 | 25 | 18 | 7 | 35 | 22 | 10 | 45 | 26 | 13 | 60 | 29 | 18 |
| 24" | 21 | 13 | 6 | 35 | 20 | 8.5 | 50 | 26 | 12 | 65 | 30 | 16 | 80 | 33 | 19 |
| 27" | 27 | 14 | 6 | 50 | 24 | 9.5 | 70 | 29 | 14 | 90 | 34 | 18 | 110 | 37 | 22 |
| 30" | 36 | 16 | 6 | 60 | 25 | 9.5 | 90 | 33 | 15.5 | 120 | 38 | 20 | 140 | 41 | 24 |
| 36" | 56 | 20 | 7 | 100 | 32 | 13 | 140 | 40 | 18 | 180 | 45 | 23 | 220 | 50 | 28 |
| 42" | 82 | 22 | 8.5 | 120 | 32 | 12 | 160 | 39 | 17 | 200 | 45 | 20 | 260 | 52 | 26 |
| 48" | 120 | 26 | 10 | 170 | 37 | 14 | 220 | 46 | 19 | 270 | 54 | 23 | 320 | 64 | 37 |

Source: Knoxville Engineering Department

L_A = Apron Length

Apron Width = L_A + Culvert Diameter

Riprap Aprons for High Tailwater (downstream flow depth > 0.5 x pipe diameter)

| Culvert Diameter | Lowest Value | | | Intermediate Values to Interpolate From | | | | | | | | | Highest Value | | |
|------------------|--------------|----------------|-----------------|---|----------------|-----------------|-----|----------------|-----------------|-----|----------------|-----------------|---------------|----------------|-----------------|
| | Q | L _A | D ₅₀ | Q | L _A | D ₅₀ | Q | L _A | D ₅₀ | Q | L _A | D ₅₀ | Q | L _A | D ₅₀ |
| | Cfs | Ft | In | Cfs | Ft | In | Cfs | Ft | In | Cfs | Ft | In | Cfs | Ft | In |
| 12" | 4 | 8 | 6 | 6 | 18 | 6 | 9 | 28 | 6 | 12 | 36 | 7 | 14 | 40 | 8 |
| 15" | 7 | 8 | 6 | 10 | 20 | 6 | 15 | 34 | 6 | 20 | 42 | 7.5 | 25 | 50 | 10 |
| 18" | 10 | 8 | 6 | 15 | 22 | 6 | 20 | 34 | 6 | 30 | 50 | 9 | 40 | 60 | 11 |
| 21" | 15 | 8 | 6 | 25 | 32 | 6 | 35 | 48 | 7 | 45 | 58 | 11 | 60 | 72 | 14 |
| 24" | 20 | 8 | 6 | 35 | 36 | 6 | 50 | 55 | 8.5 | 65 | 68 | 12 | 80 | 80 | 15 |
| 27" | 27 | 10 | 6 | 50 | 41 | 6 | 70 | 58 | 10 | 90 | 70 | 14 | 110 | 82 | 17 |
| 30" | 36 | 11 | 6 | 60 | 42 | 6 | 90 | 64 | 11 | 120 | 80 | 15 | 140 | 90 | 18 |
| 36" | 56 | 13 | 6 | 100 | 60 | 7 | 140 | 85 | 13 | 180 | 104 | 18 | 220 | 120 | 23 |
| 42" | 82 | 15 | 6 | 120 | 50 | 6 | 160 | 75 | 10 | 200 | 96 | 14 | 260 | 120 | 19 |
| 48" | 120 | 20 | 6 | 170 | 58 | 7 | 220 | 85 | 12 | 270 | 105 | 16 | 320 | 120 | 20 |

Source: Knoxville Engineering Department

L_A = Apron Length

Apron Width = 0.4 L_A + Culvert Diameter



Good example of dissipator apron construction for low tailwater conditions.



Poor placement of outlet dissipator rock; poor ditch lining (no grass, mulch, or blanket); poor slope protection.

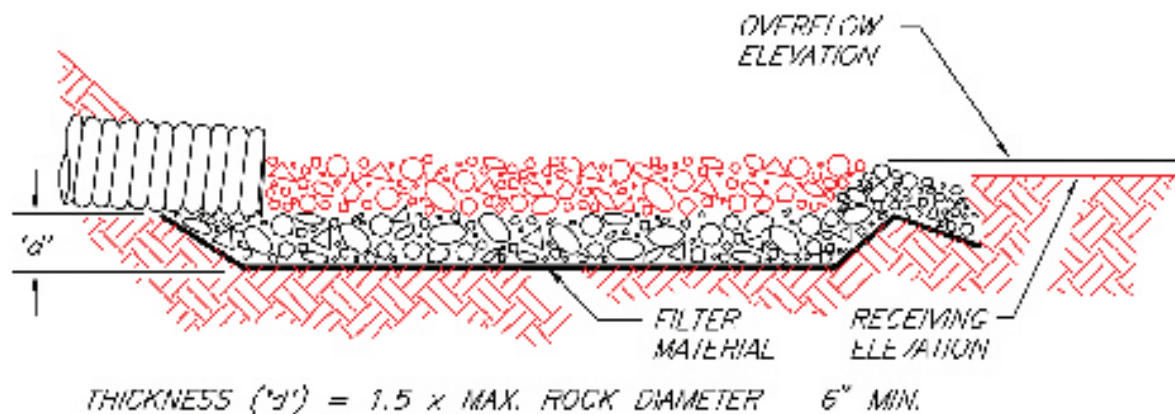

SECTION

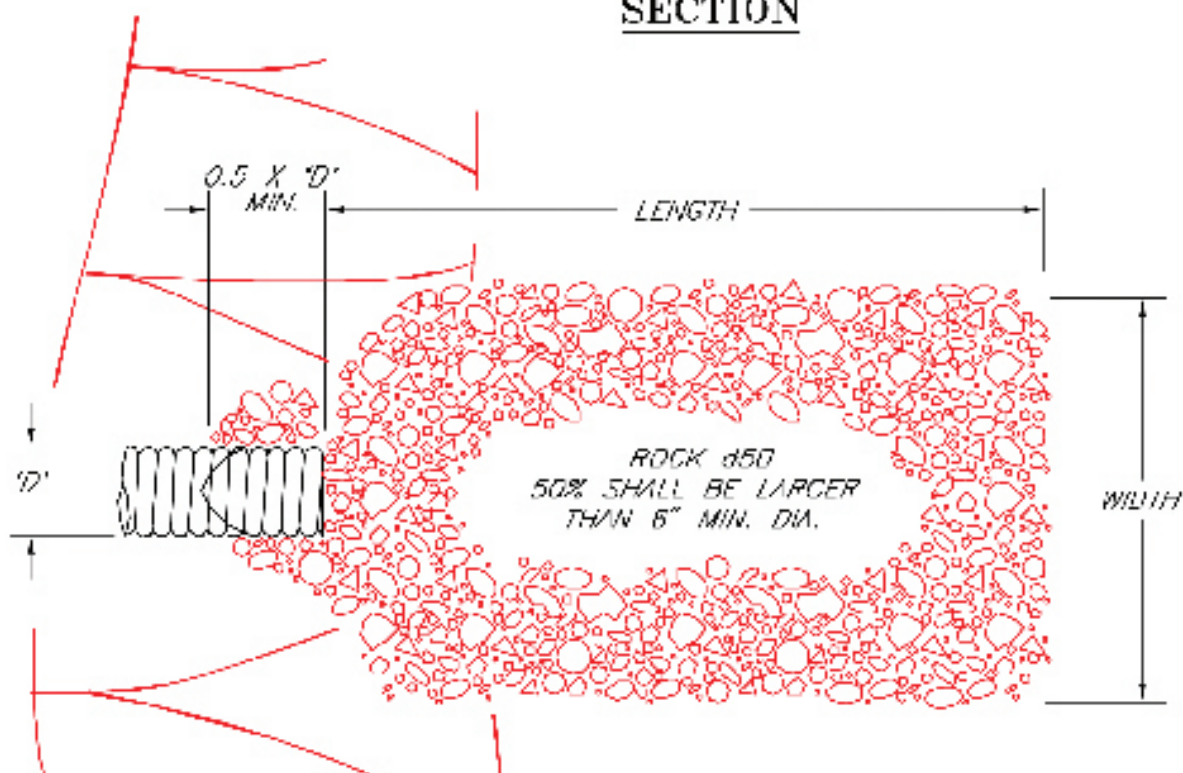

PLAN

NOTES:

1. THE LENGTH AND WIDTH SHALL BE DETERMINED BY THE ENGINEER.
2. APRON SHALL BE SET AT A ZERO GRADE AND ALIGNED STRAIGHT.
3. FILTER MATERIAL SHALL BE FILTER FABRIC OR 6" THICK MINIMUM GRADED GRAVEL LAYER.

CULVERT OUTLET ENERGY DISSIPATOR

SOURCE: SALIX APPLIED EARTHCARE -
EROSION DRAW 5.0

4.6 Drainage System Controls

4.6.5 Rock-Lined Ditches and Channels



Rock is plentiful and relatively inexpensive in most locations in Kentucky and works well as a ditch liner. For a “greener” look, use grass with ECBs or TRMs (see the blanket/mat section in the “Slope Protection” chapter).

Definition

Rock-lined channels are stormwater channels or ditches lined with rock or riprap.

Purpose

Rock-lined channels serve to convey concentrated surface runoff without erosion. Grass lining with ECBs or TRMs are recommended instead of rock. Rock lining may be necessary in the following conditions:

- There is not enough time to construct, seed, and establish a stabilized vegetated channel before the channel is expected to carry stormwater flows (i.e., construction during wet seasons).
- Design velocity exceeds 2 feet per second and conditions are not suitable for channel or ditch vegetation even if TRMs are used.
- Ditches or drainage channel slopes are greater than 2 percent and located in highly erodible soils that have a low-maximum permissible velocity that cannot be overcome with TRMs.
- Channel design velocity exceeds that allowable for a grass-lined channel with ECB or TRM liners.
- The channel will continue to down-cut without protection because it is adjusting to increased flow or a new base line (outlet elevation).

KYTC weight and size of riprap rock

| Channel Lining Riprap Class | Corresponding Size |
|-----------------------------|---|
| 1A | Limestone with 100% passing a 5-inch sieve, and no more than 20% passing through square openings 1.5" by 1.5" |
| II | Limestone with 100% passing a 9-inch sieve, and no more than 20% passing through square openings 5" by 5" |
| III (Cyclopean Riprap) | > 80% by volume of individual stones ranging from ¼ to 1-½ cubic feet |

Design Criteria

The channel must be designed to carry the 10-year, 24-hour peak flow using the formula below:

$$Q = VA, \text{ where}$$

Q = flow

V = velocity

A = flow area

The Manning equation below must be used to determine the velocity:

$$V = 1.486(R)^{2/3}S^{1/2}/n, \text{ where}$$

V =velocity

R =flow area/wetted perimeter

S =slope in feet/foot

$$n = 0.0395 (D_{50})^{1/6}$$

The maximum depth must be determined from the following equation:

$$D_{\max} = \tau / (62.4 * S), \text{ where}$$

D_{\max} = maximum depth of flow

S = slope in feet/foot

τ = maximum tractive force of the liner in lbs/ft²

The values for KYTC channel lining are shown below:

KYTC Channel Lining Rock Sizing

| KYTC Channel Lining | D_{50} | Shear Lb/ft. ² | Manning's n |
|---------------------|----------|---------------------------|---------------|
| Class 1A | 0.2 | 1.0 | 0.0302 |
| Class II | 0.5 | 2.5 | 0.0352 |
| Class III | 1.0 | 5.0 | 0.0395 |

Side slopes must be 2:1 or flatter

Riprap thickness— $T = 1.5$ times the largest stone diameter or as shown on the plans; 6-inch thick minimum

Foundation—Use extra-strength, non-woven filter fabric or an aggregate filter layer, if required.

The outlet must be stable with a suitable outlet stabilization energy dissipator.

Construction Specifications

Excavate the cross-section to the grades shown on plans. Overcut for thickness of rock and filter.

Place non-woven filter fabric or gravel filter layer, and place the rock as soon as the foundation is prepared.

Place rock so it forms a dense, uniform, well-graded mass with few voids. Hand placement might be necessary to obtain good size distribution.

No overfall of channel construction should exist. Grass-lined channels with riprap bottoms must have a smooth contact between riprap and vegetation.

Channel outlet must be stabilized with a suitable outlet stabilization energy dissipator.

Inspection and Maintenance

Inspect channels weekly and after rainfalls greater than one-half inch. Remove debris and make needed repairs where stones have been displaced. Take care not to restrict the flow area when stones are replaced.

Give special attention to outlets and points where any concentrated flow enters the channel. Repair eroded areas promptly. Check for sediment accumulation, piping, bank instability, and scour holes and repair promptly.



Here is a good example of rock-lined ditch. The seeding is a bit too thick on the side slopes.



This shows a very good stabilization of slope and ditch on highway project. Note the mix of large and small rock, which helps fills voids and deters undermining.



The rock is a little thin along this ditch, but could be acceptable because of the lack of visible channel erosion. Ditches should be monitored so that rock or other protective controls can be added if erosion becomes a problem.

Rock lined ditches can function as slope drains in steep terrain. Flow dissipaters are required to reduce scour forces at slope bottoms, and geotextile should be used under rock to prevent undercutting. Note spotty seeding on this slope - use of erosion control blankets would have helped protect topsoil and seed during germination, and provided better vegetative cover.



DESIGN HEIGHT (H), WIDTH AND STONE SIZE SHALL
BE DETERMINED BY THE ENGINEER

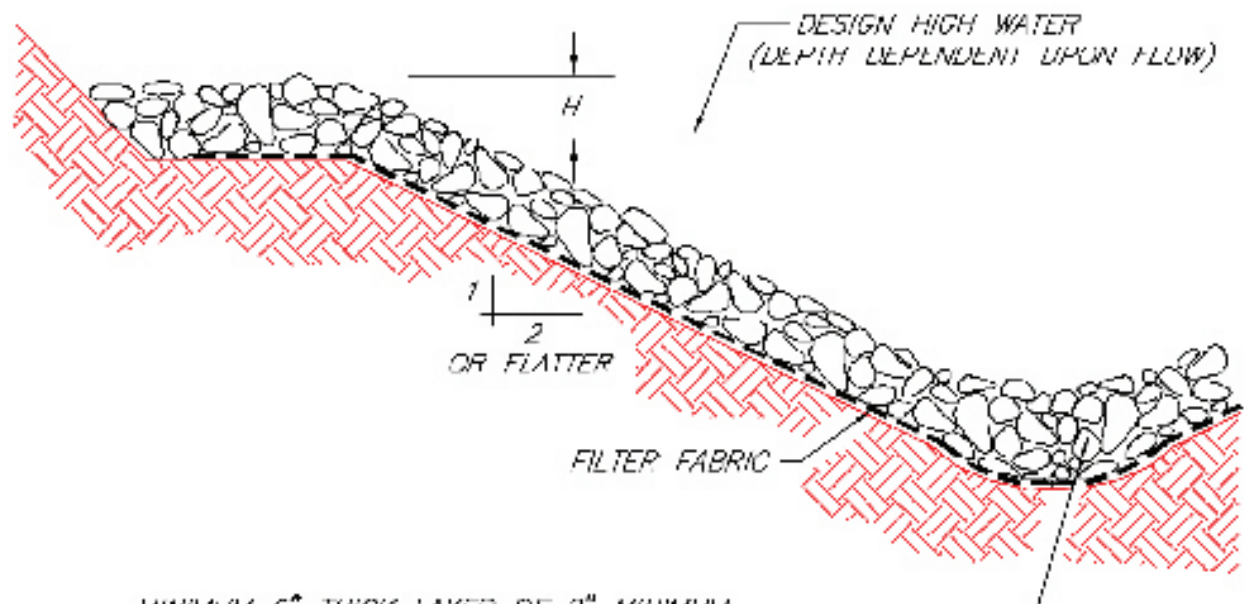

MINIMUM 6" THICK LAYER OF 2" MINIMUM
DIAMETER DRAIN ROCK. LARGER STONE SHALL BE USED
DEPENDENT UPON GRADIENT, SOIL TYPE, AND DESIGN FLOW.

TYPICAL SECTION

ROCK LINED CHANNEL

SOURCE: SALIX APPLIED EARTHCARE -
EROSION DRAW 5.0

4.6 Drainage System Controls

4.6.6 Grass-Lined Ditches and Channels



Wide and relatively flat ditches can be protected with triple-seeding and degradable ECBs or mulch. Steeper ditches (e.g., slopes of up to 10 percent and more in some cases) can also be seeded if TRMs are used (see the Blankets and Mats section in the Slope Protection chapter).

Definition

This consists of vegetation lining a ditch, channel, swale, or diversion berm to protect it from erosion.

Purpose

Grass protection of channels reduces erosion by lowering water velocity over the soil surface and by binding soil particles with roots. Grass-lined channels should be used where

- A vegetative lining can provide sufficient stability for the channel grade by increasing maximum permissible velocity.
- Slopes are generally less than 10 percent, with protection from shear stress as needed through the use of mulch, ECBs, TRMs, or cellular/geogrid products.
- Site conditions required to establish vegetation (i.e., climate, soils, topography, and temporary/permanent protection for vegetation such as via mulch, ECBs, or TRMs) are present.

Design Criteria

Grass-lined channels resemble natural systems and are usually preferred where design velocities are suitable. Select appropriate vegetation and construct ditches or channels early in the construction schedule before grading and paving increase runoff rates.

- Generally, grass-lined channels are constructed in stable, low areas to conform with the natural drainage system, but they might also be needed along roadways or property boundaries. To reduce erosion potential, design the channel to avoid sharp bends and steep grades.
- For ditches and channels with slopes exceeding 3 percent, use the information in the Erosion Control Blankets and Turf Reinforcement Mats Fact Sheets to design and build grass-lined channels with appropriate scour and erosion protection (i.e., ensure that the ditch liner can appropriately resist shear stresses, given the slope and length of the ditch).

The channel cross-section should be wide and shallow with relatively flat side slopes (e.g., 3H:1V) so surface water can enter over the vegetated banks without erosion. Riprap might be needed to protect the channel banks at intersections where flow velocities approach allowable limits and turbulence could occur. **Specify that grass be triple-seeded for all ditch/channel applications, and that appropriate mulch, erosion control blanket, or turf reinforcement matting be used.**



Cross-section designs include:

V-shaped Channels

Generally these are used where the quantity of water is relatively small, such as roadside ditches. The V-shaped cross-section is desirable because of difficulty stabilizing the bottom, where velocities may be high. A sod or grass lining protected with ECBs or TRMs might suffice where velocities are low; use rock or riprap lining to protect against higher velocities.

Parabolic Grass Channels

Often these are used where larger flows are expected and sufficient space is available. The shape is pleasing and may best fit site conditions. Riprap should be used where higher velocities are expected and where some dissipation of energy (velocity) is desired. Combinations of grass with riprap centers or turf reinforcement mat centers are useful where there is a continuous low flow in the channel.

Trapezoidal Grass Channels

These are used where runoff volumes are large and slope is low so that velocities are non-erosive to vegetated linings. Low flow channel can be lined with turf reinforcement mats, erosion control blankets, riprap, or pavement if desired.

- Grass-lined channels must not be subject to sedimentation from disturbed areas.
- An established grass-lined channel resembles natural drainage systems and is usually preferred if design velocities are below 5 feet per second.
- Channels with design velocities greater than 2 feet per second will require that turf reinforcement mats or erosion control blankets be installed at the time of seeding to provide stability until the vegetation is fully established. It might also be necessary to divert water from the channel until vegetation is established or to line the channel with sod.
- Whenever design velocities exceed 4 feet per second a permanent type of turf reinforcement mat will be necessary.
- Sediment traps might be needed at channel inlets to prevent entry of muddy runoff and channel sedimentation.

Capacity

The channel must be designed to carry the 10-year, 24-hour peak flow using the formula below:

$$Q = VA, \text{ where}$$

$$Q = \text{flow}$$

$$V = \text{velocity}$$

$$A = \text{flow area}$$

The Manning equation below must be used to determine the velocity:

$$V = 1.486(R)^{2/3}S^{1/2}/n, \text{ where}$$

$$V = \text{velocity}$$

$$R = \text{flow area/wetted perimeter}$$

$$S = \text{slope in feet/foot}$$

$$n = 0.045 \text{ for grass}$$

The maximum depth must be determined from the following equation:

$$D_{\max} = \tau / (62.4 * S), \text{ where}$$

$$D_{\max} = \text{maximum depth of flow}$$

$$S = \text{slope in feet/foot}$$

$$\tau = \text{maximum tractive force of the liner in lbs/ft}^2$$

The maximum shear stress for various liners is shown below:

Maximum Shear Stress of Liners

| Material | Shear lb/ft ² |
|---|-----------------------------|
| Dense sod, fair condition (Class D/E), moderately cohesive soil | 0.4 |
| Bermuda grass, fair stand < 12 cm tall, dormant | 0.9 |
| Bermuda grass, good stand <12 cm tall, dormant | 1.1 |
| Bermuda grass, excellent stand 20 cm tall, dormant | 2.7 |
| Bermuda grass, excellent stand 20 cm tall, green | 2.8 |
| Bermuda grass, excellent stand >20 cm tall, green | 3.2 |
| Turf (immediately after construction) | 0.2 |
| Turf (after 3-4 seasons) | 2.0 |
| Turf reinforcement mat, permanent | 8.0 |
| Straw reinforcement mat, temporary | 0.5 |
| Jute mat | 0.5 |
| Straw with net | 1.5 |
| Curled wood net | 1.6 |
| Synthetic mat | 2.0 |

Source: *Salix Applied Earthcare – Erosion Draw 5.0*

Cross-section

The channel shape may be parabolic, trapezoidal, or V-shaped, depending on need and site conditions.

Side Slopes

Grassed channel side slopes generally are constructed 3:1 or flatter to aid in the establishment of vegetation and for maintenance.

Grade

Generally restricted to slopes 5 percent or less unless ditch length is less than 200 ft and TRMs are used. Either a uniform or gradually increasing grade is preferred to avoid sedimentation.

Construction Specifications

See the specifications for seeding and ECBs.

Inspection and Maintenance

During the initial establishment, grass-lined channels should be repaired and grass reestablished if necessary.

After grass has become established, check the channel periodically to determine if it is withstanding flow velocities without damage.

Check the channel for debris, scour, or erosion and immediately make repairs. It is particularly important to check the channel outlet and all road crossings for bank stability and evidence of piping or scour holes and make repairs immediately.

Remove all significant sediment accumulations to maintain the designed carrying capacity.

Keep the grass in a healthy, vigorous condition at all times, because it is the primary erosion protection for the channel.

Permanent grassed waterways should be seasonally maintained by mowing or irrigating, depending on the type of vegetation selected. The long-term management of ditches and channels as stable, vegetated, *natural* drainage systems with native vegetation buffers is highly recommended because of the inherent stability offered by grasses, shrubs, trees, and other vegetation; greater visual and other aesthetic benefits provided by native plant buffers; and higher habitat and property values.



Here is an excellent construction of triple-seeded ditch with excelsior blanket. Ditches should be stabilized, seeded, and mulched immediately after construction.



When using blankets and mats, make sure product has good soil contact throughout the ditch. Use plenty of staples to protect against surge flows during heavy rains. Blankets and mats are extremely vulnerable before seed germination, and can be dislodged by high-velocity flows if stapling is insufficient.

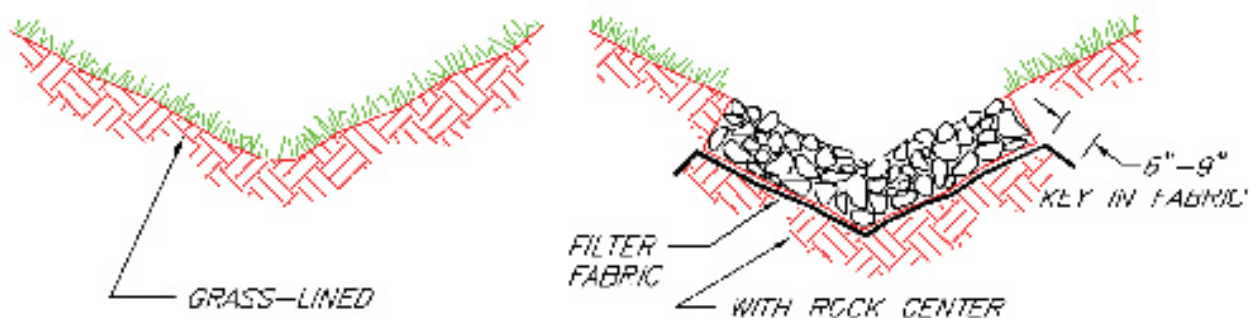

TYPICAL V-SHAPED CHANNEL CROSS-SECTION



TYPICAL PARABOLIC CHANNEL CROSS SECTION

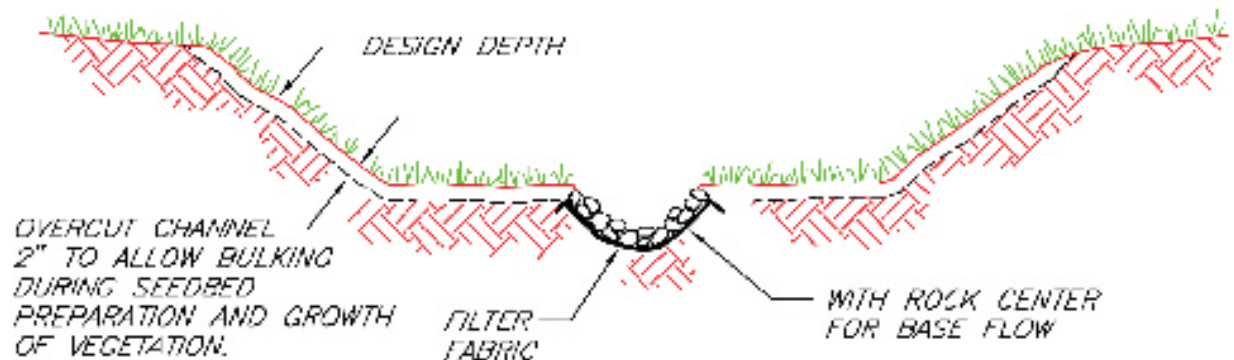

TYPICAL TRAPEZOIDAL CHANNEL CROSS-SECTION

**GRASS-LINED CHANNEL
TYPICAL CROSS SECTIONS**

SOURCE: SALIX APPLIED EARTH CARE -
EROSION DRAW 5.0

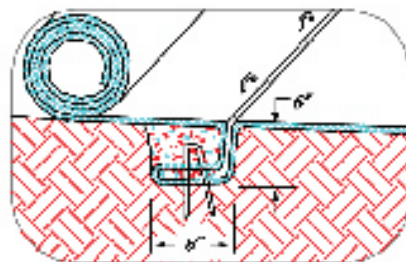
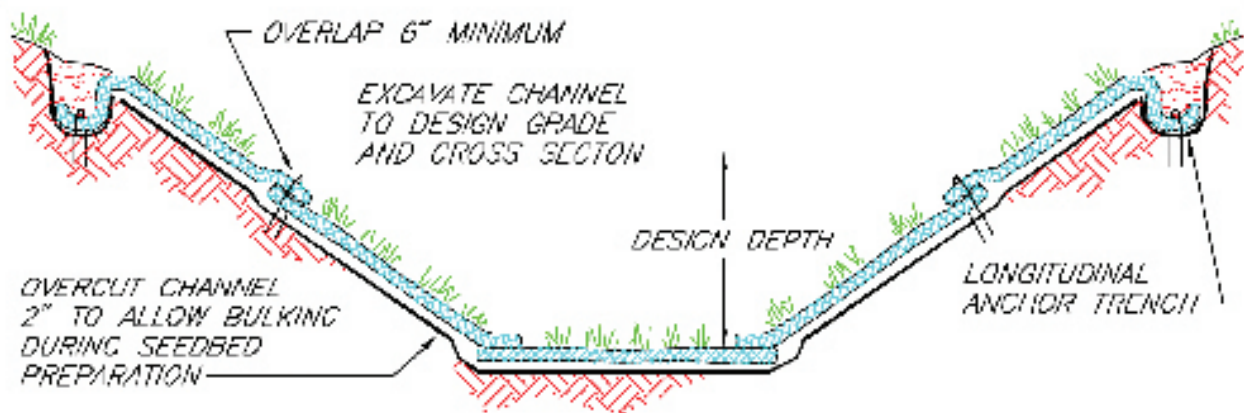

TYPICAL INSTALLATION WITH EROSION CONTROL BLANKETS OR TURF REINFORCEMENT MATS

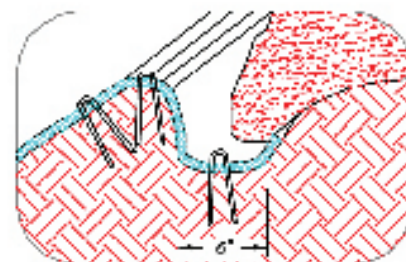

INTERMITTENT CHECK SLOT

LONGITUDINAL ANCHOR TRENCH

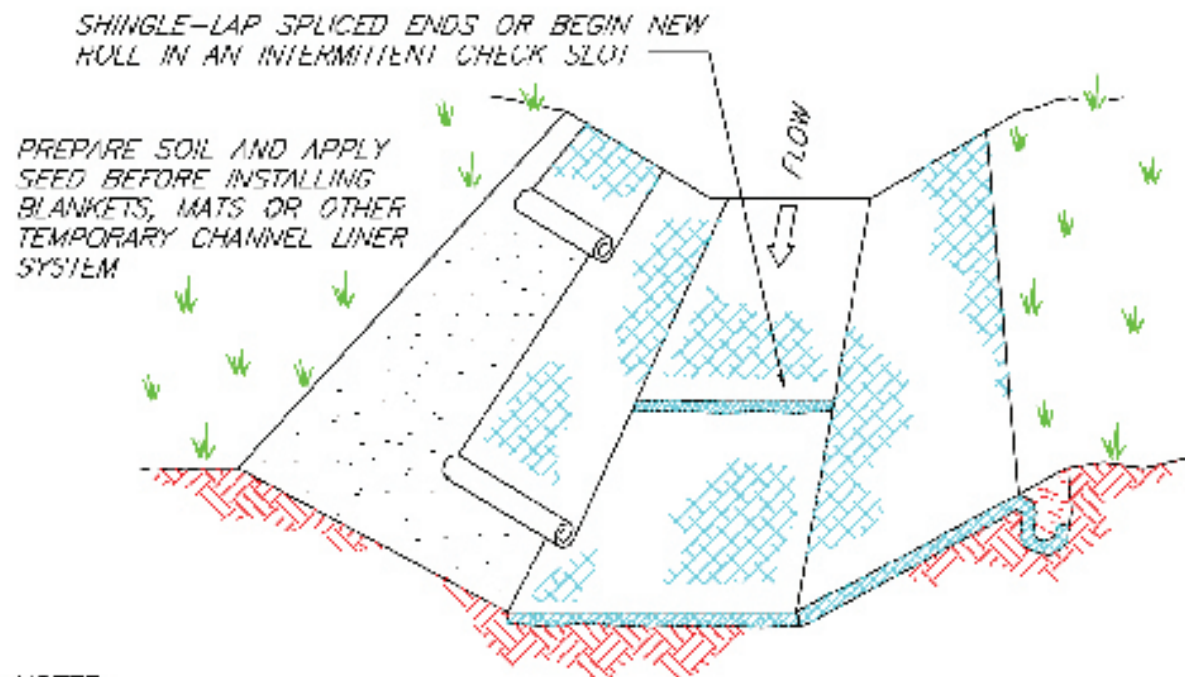

- NOTES:
1. DESIGN VELOCITIES EXCEEDING 2 FT/SEC REQUIRE TEMPORARY BLANKETS, MATS OR SIMILAR LINERS TO PROTECT SEED AND SOIL UNTIL VEGETATION BECOMES ESTABLISHED.
 2. GRASS-LINED CHANNELS WITH DESIGN VELOCITIES EXCEEDING 6 FT/SEC SHOULD INCLUDE TURF REINFORCEMENT MATS.

NOT TO SCALE

**GRASS-LINED CHANNEL
TYPICAL INSTALLATION**

SOURCE: SALIX APPLIED EARTHCARE –
EROSION DRAW 5.0

4.6 Drainage System Controls

4.6.7 Check Dams for Ditches and Channels



Check dams, also known as "ditch checks," can help to control downcutting in drainage ditches before grass is well established. In this example, checks are working even though ditch seeding and mulching appears to be somewhat poor. Many contractors use half-filled fabric bags of stone for ditch checks because of their ease of handling, acceptability for reuse, and overall effectiveness.

Definition

A check dam (also known as a ditch check or silt check) is a small, temporary, center-overflow dam constructed across a ditch, swale, or channel, consisting of rock, gravel filled bags, fiber rolls, or other commercial products.

Purpose

The purpose of a check dam is to reduce the velocity of concentrated stormwater flows, thereby reducing erosion of the swale or channel. This practice also traps sediment.

Design Criteria

Check dams must be limited to use in small, open ditches that drain 10 acres or less. Check dams must not be used in streams. Straw bales are not to be used as check dams because of past high failure rates.

- Ditches lined with riprap do not usually require check dams; however they can be used in areas with highly erodible soils, steep slopes, and drainage areas of up to 5 acres. Check dams are especially applicable where the slope of ditches or channels is close to the maximum for a grass lining.
- The maximum height of a check dam must be 3 feet above the ground on which the rock is placed.
- The center of the check dam above the flat portion of the channel must be at least 6 inches lower than the outer edges.
- The maximum spacing between rock check dams in a ditch should be such that the toe of the upstream dam is at the same elevation as the top of the downstream dam.
- Check dams for larger projects with greater slopes and wider drainage swales can be constructed of trees and brush cleared from the site, gabions, large rock, or other materials. Design and structural stability requirements for these applications, which can have significant benefits, are very site specific.

Construction Specifications

Stone check dams must be constructed of KYTC Class 2 channel lining. Fiber bags filled with gravel are also acceptable. Bags should be of woven-type geotextile fabric because burlap or cloth bags deteriorate rapidly. The fiber bags must be filled with three-quarter inch drain rock or one-quarter inch pea gravel. Fill



fiber bags just over halfway, so they can be packed tightly together without large gaps.

- Commercial products such as fiber rolls, sediment dikes, and sediment fencing can be used in seeded and lined (or mulched) swales with bottoms not less than 4 feet wide and slopes not more than 3 percent, if appropriate. Follow the manufacturer's instructions for placement, staking, and maintenance. Applications in areas that exceed these parameters must be consistent with product design and performance information.
- Stone must be placed by hand or mechanically as necessary to achieve complete coverage of the ditch bottom and banks and to ensure that the center of the check dam is at least 6 inches lower than the outer edges.
- Gravel bag check dams must be placed in the ditch or channel by hand, with the tied ends of the bags pointing upstream and the center overflow area at least 6 inches lower than the outer edges.
- For all check dams, ensure that the higher elevation outer sidewalls tie into the upper portion of the ditch or channel bank to prevent bypasses.
- If stone check dams are used in grass-lined channels that will be mowed, take care to remove all stone from the channel when the dam is removed. This includes any stone that has washed downstream.

Inspection and Maintenance

Regular inspections must be made to ensure that check dams are in good working order and the center of the dam is lower than the edges. Erosion caused by high flows around the edges of the dam must be corrected immediately, and the dam must be extended upward beyond the repaired area.

Inspect check dams for sediment accumulation weekly and after each rainfall greater than one-half inch. Sediment must be removed when it reaches one-half of the original height.

Check dams must remain in place and operational until the drainage area and channel are completely stabilized, or up to 30 days after the permanent site stabilization is achieved.

Check dams must be removed when their useful life has been completed. In temporary ditches and swales, check dams must be removed and the ditch filled in when it is no longer needed. In permanent channels, check dams must be removed when a permanent lining can be installed. In the case of grass-lined ditches, check dams must be removed when the grass has matured sufficiently to protect the ditch or swale. The area beneath the check dams must be seeded and mulched or sodded (depending upon velocity) immediately after check dams are removed.

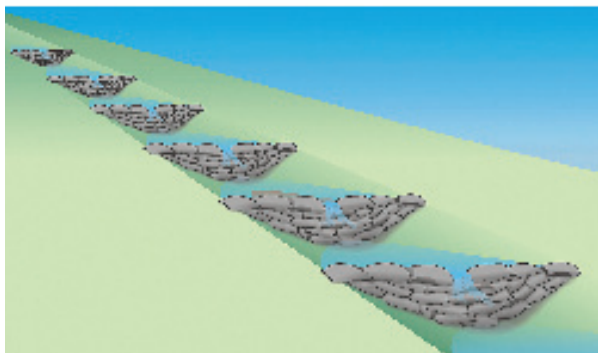
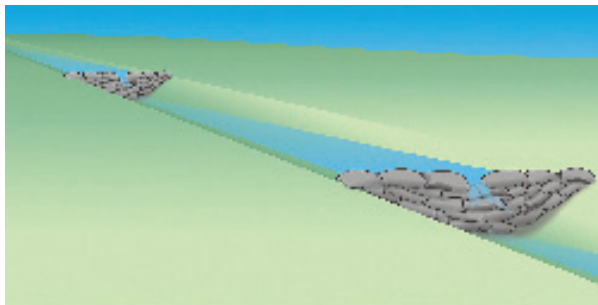

Install check dams closer together in steep ditches (bottom) and farther apart in flatter ditches (top). Make sure overflow is in the center of the dam. Ditch checks are temporary controls, and should be removed when the ditch and upland areas are stabilized.

L = THE DISTANCE SUCH THAT
POINTS A AND B ARE OF
EQUAL ELEVATION

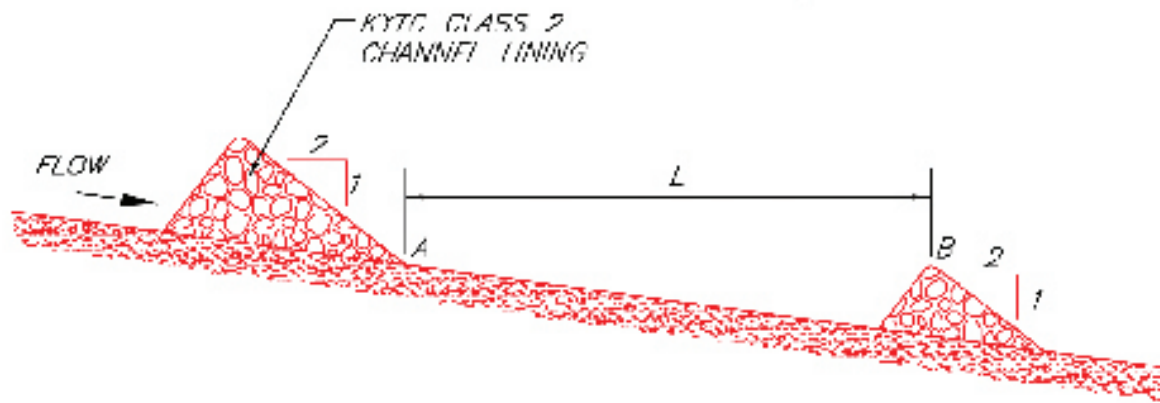

LONGITUDINAL SECTION SHOWING
SPACING BETWEEN CHECK DAMS

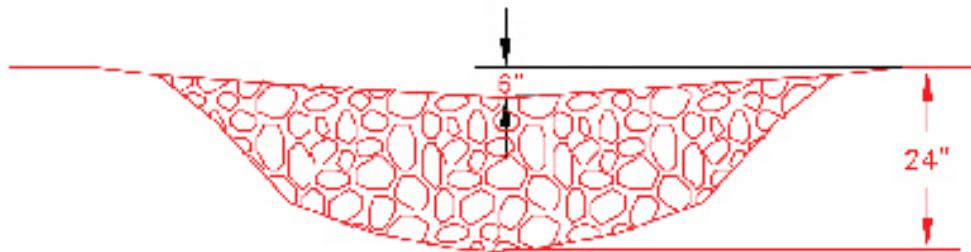

SECTION ACROSS CHANNEL

CHECK DAM

4.7 Sediment Traps and Basins

General Information

The purpose of a temporary trap or basin is to provide an area where muddy runoff is allowed to pond, so sediment will settle out. Sediment traps and basins should be installed in selected drainage areas before excavation or fill work begins. **Do not depend on sediment traps and basins alone to control sediment loss from your construction site.** Sediment basins and traps should fill with muddy runoff during and immediately after a rain storm and drain down slowly over the next 1–2 days.

Containment for the ponding area can be provided by an excavation or a dike made of earth or stone. Low-lying sites on the downhill side of bare soil areas are ideal places to install temporary sediment traps and basins. In general, sediment traps are designed to treat runoff from about 1 to 5 acres. Sediment basins are larger, and serve areas larger than 5 acres. Basins draining areas larger than 10 acres require an engineered design and are often designed to function as a permanent stormwater treatment pond after construction is complete.

If feasible, do not put sediment traps or basins in or next to flowing streams or other waterways. Make sure pooled water does not flood buildings, roadways, utilities, or other structures. Construction of a permanent, stable outlet is key to long-term performance.

Temporary Sediment Traps

Any depression, swale, or low-lying place that receives muddy flows from exposed soil areas can serve as a sediment trap site. Installing several small traps at strategic locations is often better than building one large basin. The simplest approach is to dig a hole or build a dike (berm) of earth or stone where concentrated flows are present. This will help to detain runoff so sediment can settle out. The outlet can be a rock-lined depression in the containment berm.

Sediment Basins

Sediment basins are somewhat larger than traps, but the construction approach is similar. Sediment basins usually have more spillway protection because of their larger flows. Most have risers and outlet pipes rather than rock spillways to handle the larger flows. Sediment basins are often designed to serve later as stormwater treatment ponds. If this is the case, agreements might be required assigning responsibility for long-term sediment removal and general maintenance.



Small, temporary sediment traps intercept and detain construction site runoff so soil particles can settle out. Note how the outlet riser for this trap has been wrapped with filter fabric to increase detention time and trap suspended sediment. Designing traps and basins with long flow paths between the inlet and outlet also helps to increase sediment removal efficiency by extending the detention time. Where space restrictions prevent long basin designs, barriers placed in the basin can lengthen detention times by creating a serpentine flow path between the inlet and outlet.

4.7 Sediment Traps and Basins

4.7.1 Temporary Sediment (Silt) Traps



Simple traps or “checks” with rock berm containment structures can be installed as needed by field personnel with or without specific notations on plan documents. Standard notes on plans should call for installation of temporary traps in concentrated flow areas subject to rutting on an as-needed basis. Make sure containment berms are designed for overflow in the center of the berm, to prevent sidecutting and bypasses. Install traps in a series to control sediment from large upland areas.

Definition

A temporary sediment or silt trap is formed by excavation or by constructing a small embankment of stone, stone-filled bags, or other material to retain sediment. Sediment traps are considered temporary structures and often placed at the site on an *as needed* basis by field personnel. They should not be placed in flowing streams.

Purpose

Sediment traps pond and settle sediment from muddy runoff. Traps are used where physical site conditions or other restrictions prevent other erosion control measures from adequately controlling erosion and sedimentation. Sediment traps can be used downslope from construction operations that expose areas to erosion.

Design Criteria

Bermed sediment traps confined by rock, rock-filled fiber bags, or other material are preferred over excavated traps or those with soil berms. Traps are placed in converging flow areas (i.e., where ruts or washouts can form) or in ditches, where they are often called ditch checks or check dams. All traps are sized according to a design volume of 3,600 cubic feet per disturbed acre in the upstream drainage area. Multiple sediment traps constructed in a series are needed when the storage volume of each cannot meet this design requirement.

Sediment traps are generally used to treat a drainage area of 5 acres or less. When the total drainage area exceeds 10 acres, an engineered sediment basin is usually necessary. Traps cannot be placed in blue-line streams or other regulated waters unless space limitations or design limitations provide no other feasible option. A USACE Clean Water Act (CWA) section 404 permit is required in these cases. Sediment traps must be cleaned out when they are one-third full of sediment.

KYTC Silt Trap Types A, B, and C

The KYTC specifies three types of temporary sediment or silt traps. Type A is an excavated basin with or without a soil berm constructed in a ditch or drainageway. Type B is one or more small berms of rock (KYTC No. 2 or shot rock) placed in a drainageway or ditch, with a geotextile underliner covered by 4 inches of KYTC No. 4 stone. A 12-inch overflow depression appears in the middle of the berm(s). Type C traps are berms constructed of porous fabric bags filled with crushed aggregate (e.g., KYTC No. 57), placed individually or in a series to create small ponding dams around drop inlets, curb inlets, or to form check dams in a drainageway or ditch.

General

- Construct traps of rock (KYTC No. 2 mixed with smaller stone), rock-filled fiber bags, or use approved commercial sediment trap products installed and spaced according to manufacturer's instructions.
- Site sediment traps in areas where they can be maintained (i.e., sediment removed).
- Set traps back from property lines or water bodies as much as possible.
- Do not site sediment traps at culvert or pipe outlets if possible.
- Minimum sediment storage capacity is 3600 cubic feet per acre of upland area drained by the trap. Where space restrictions exist, install multiple traps in a series at least 50 feet apart.
- Maximum drainage area is 5 acres.
- Basin flow length should be at least two times the flow width.
- Recommended trap depth for open areas is 2 feet at the inlet and 4 feet at the outlet.
- Trap height must be 1.5 feet minimum in ditches, 3–5 feet in open area drainageways.
- Trap berm width at base must be sufficient to support 2H:1V berm.
- Trap length must be sufficient to tie into upper banks in ditches or high enough to prevent side bypasses in drainageways. Overflows must be in the center of the berm.
- Construct the trap, seed and stabilize before clearing and grading work begins.

Embankment requirements

- Maximum height of 5 feet.
- Maximum inside and outside slopes of 2:1.
- Side slopes, containment berms, and inflowing ditches should be seeded and mulched or blanketed as soon as possible after construction.

Outlet requirements

- The outlet must consist of an overflow spillway wide made of stone (KYTC No. 2 minimum).

Construction Specifications

- Construct initial series of sediment traps before general site clearing and grading.
- The area to be excavated or ponded must be cleared of all trees, stumps, roots, brush, boulders, and debris. All topsoil containing excessive amounts of organic matter must be removed.
- Seeding, fertilizing, and mulching of the material taken from the excavation must comply with the applicable soil stabilization sections of this manual.
- Any material excavated from the trap must be uniformly spread to a depth not exceeding 3 feet and graded to a continuous slope away from the trap.
- Field-approved installations should be noted on weekly or bi-weekly inspection reports and on plan documents within 7 days.

Inspection and Maintenance

The trap must be inspected weekly or every 14 days and after every rainfall greater than one-half inch. Sediment must be removed from the trap when it consumes one-third of the design volume. Plans for the sediment trap must indicate the methods for disposing of the sediment removed.

Temporary sediment traps are removed upon stabilization or cover of the upland drainage area with vegetation, pavement, and so on. The trap area should be graded, seeded, and mulched or blanketed. Excess sediment should be spread and stabilized where it will not enter the drainage system.

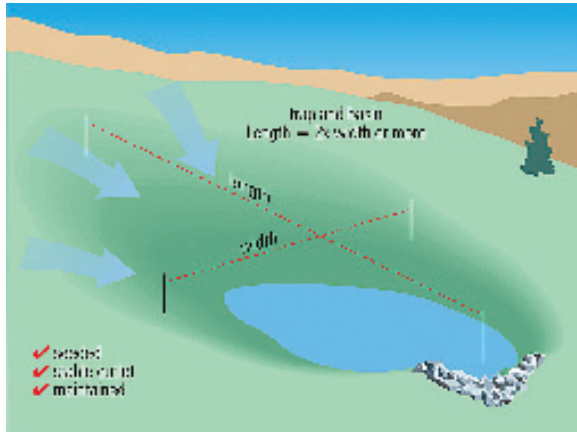

Design sediment traps with long flow paths if possible. Make sure overflow area is protected with rock or other armoring. For best results, seed trap and upland areas immediately after construction.



Make sure overflow outlet or riser is designed for maximum detention times. Note the rock berm around riser, which ensures maximum detention for muddy flows after small storms.



Good trap placement and performance; poor maintenance. Remove accumulated sediment before trap is half full. Spread material removed in a vegetated upland area or other site where it will not wash into nearby surface waters.



In areas where space is restricted, use multiple traps in a series to meet the design goal of 3600 cubic ft per acre of upland drainage. Get to final grade, seed and mulch as soon as possible to reduce trap maintenance and upkeep.

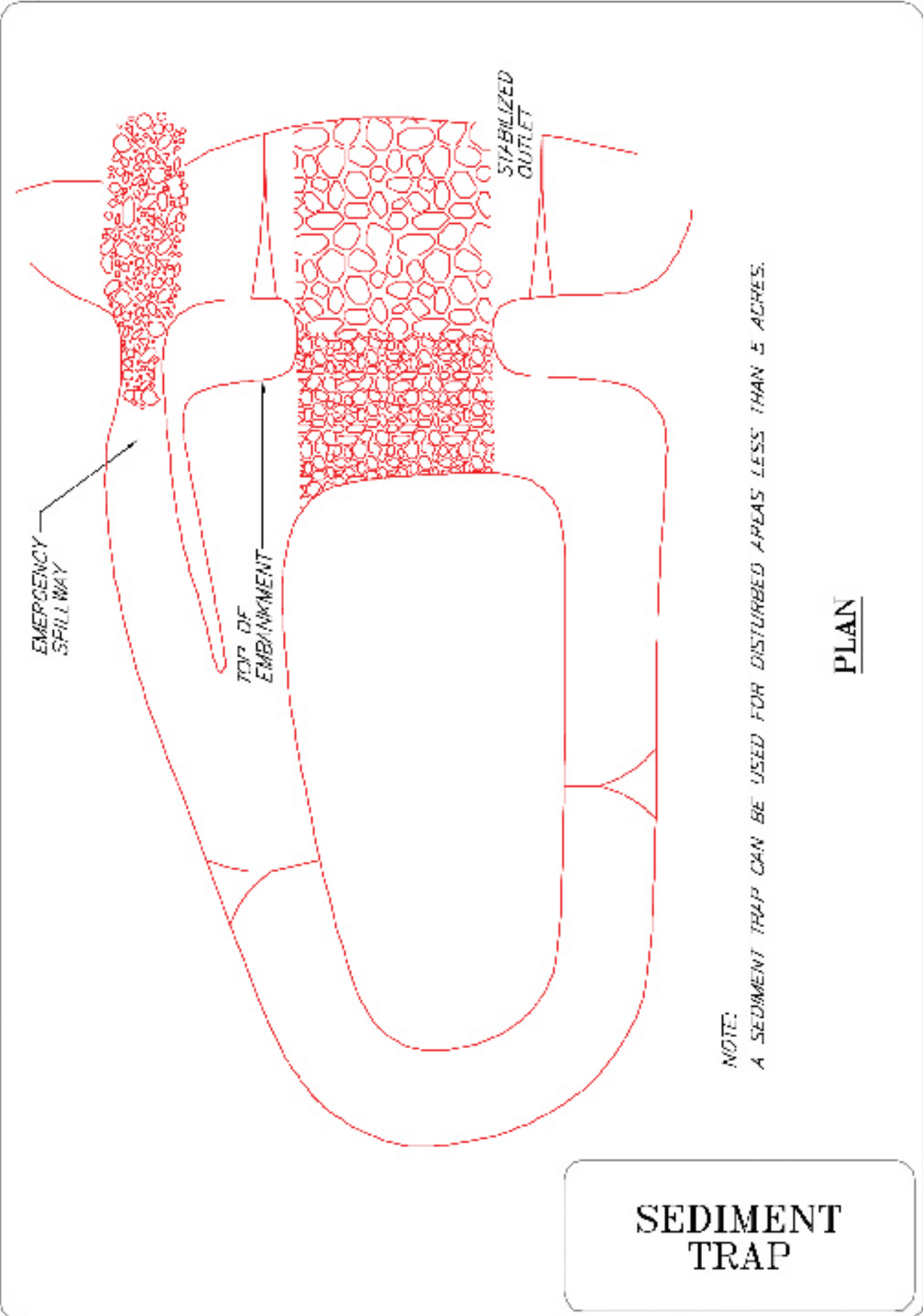

*NOTE:
A SEDIMENT TRAP CAN BE USED FOR DISTURBED AREAS LESS THAN 5 ACRES.*

SEDIMENT TRAP

PLAN

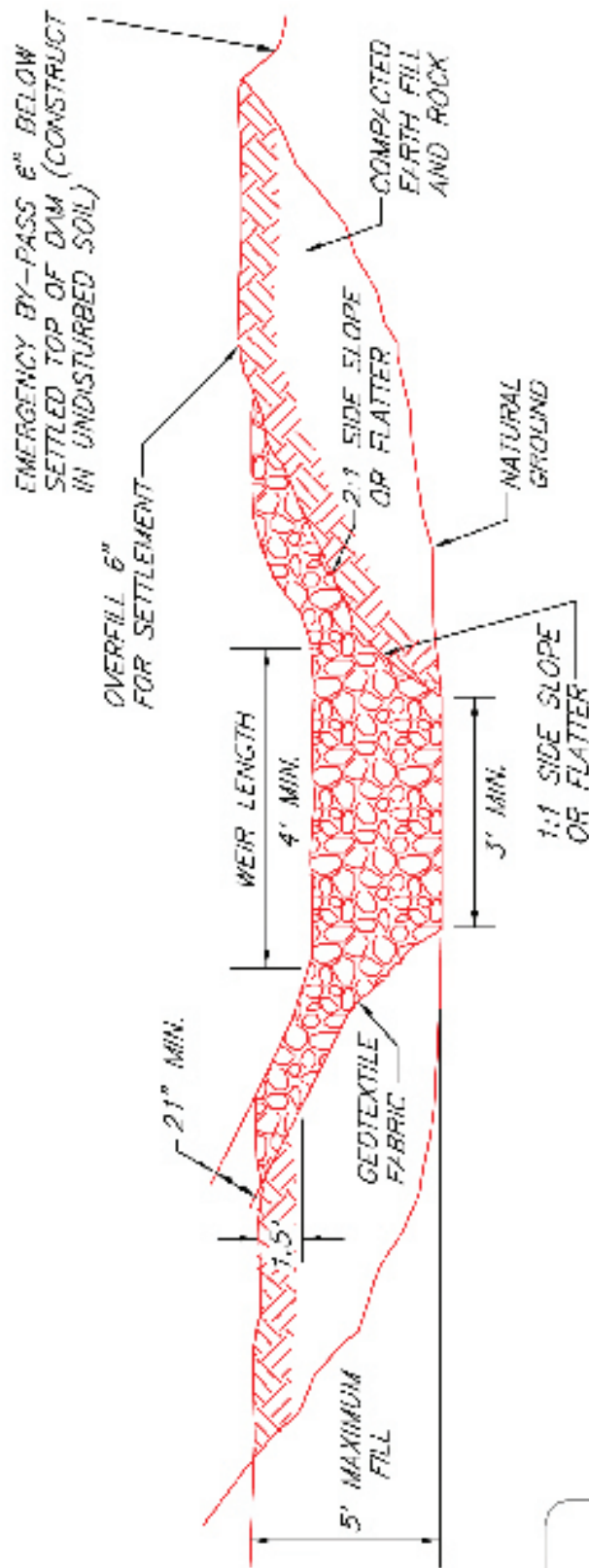

NOTE:
A SEDIMENT TRAP CAN BE USED FOR DISTURBED AREAS LESS THAN 5 ACRES.

SEDIMENT TRAP

EMBANKMENT AND SPILLWAY ELEVATION

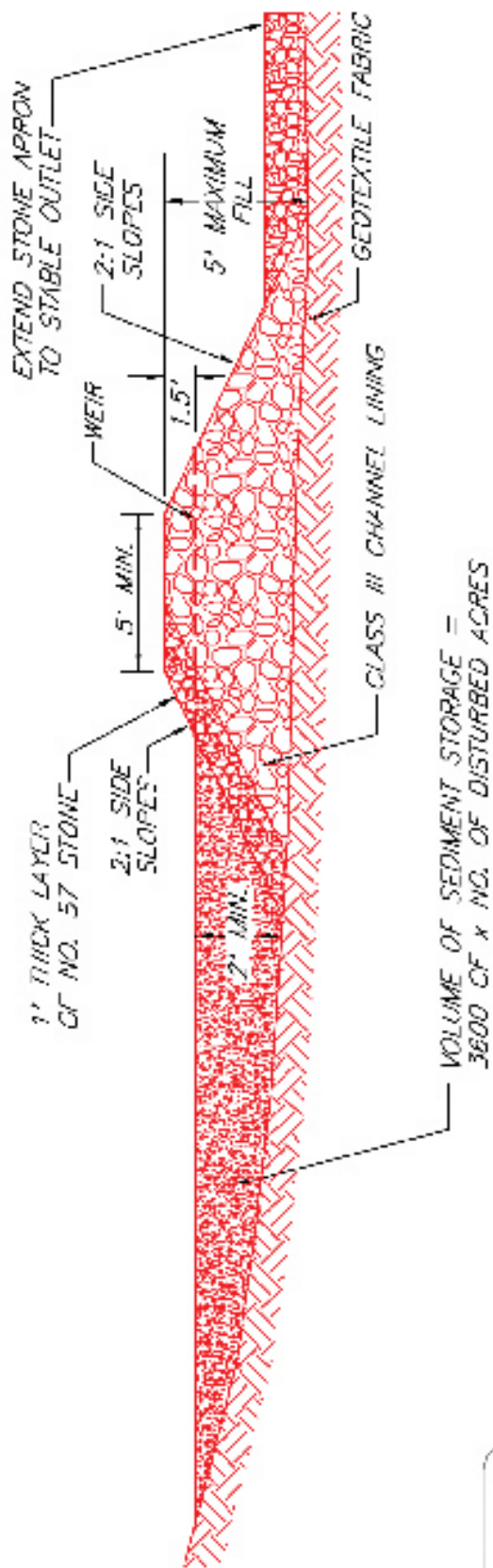

NOTE:
A SEDIMENT TRAP CAN BE USED FOR DISTURBED AREAS LESS THAN 5 ACRES.

SEDIMENT TRAP

STONE SECTION

4.7 Sediment Traps and Basins

4.7.2 Sediment (Detention) Basins



Well-stabilized detention basin with erosion control blankets protecting sidewalls during grass seed germination. Note the temporary stone berming in front of outlet, which increases detention time and promotes maximum settling of soil particles. Design of this basin could be greatly improved by adding a temporary baffle or barrier between the inlet and outlet, which would force inflows from the culvert around the baffle. The longer flow path and settling time would improve soil removal and prevent short-circuiting of the basin.



Definition

A sediment basin is a pond created by excavation and construction of an embankment and designed to retain or detain runoff sufficiently to allow excess sediment to settle out.

Purpose

The sediment basin is intended to collect and store sediment from sites that are cleared or graded during construction or for extended periods of time before permanent vegetation is reestablished or before permanent drainage structures are completed. It is intended to intercept and trap sediment before it leaves the construction site. Some basins are temporary, with a design life of 12 to 18 months, and are to be maintained until the site area is permanently stabilized. Basins that will serve as permanent stormwater treatment ponds often require modified outlet risers during construction to ensure adequate ponding times and sediment removal.

Basins should be located at the stormwater outlet from the site, not in any natural or undisturbed stream. Use of temporary dikes, pipes or channels might be necessary to divert runoff from disturbed areas into the basin and to divert runoff originating from undisturbed areas around the basin.

Design Criteria

Sediment basins must be designed by a professional engineer licensed in Kentucky. The basin should be designed using SEDCAD or other computer program. The design criteria are listed below:

General

Site sediment basins where they will provide the best treatment (longest flow path between inlet and outlet, longest settling times) for the greatest area of the site. It is recommended that basins be located in a natural drainageway in a deep constriction that has a wide area upstream for ponding detained stormwater.

- Do not locate basins where a failure would result in severe property damage or danger to human life.
- Sediment basins should be designed or modified to drain down slowly for 2–4 days after a storm event. Modify the outlet if necessary to achieve the maximum detention time.
- Minimum design storage capacity is 3600 cubic feet per acre of upland area drained. The maximum capacity for the impoundment must not exceed 10 acre-feet. If more impoundment capacity is needed, install basins in a series or site them to intercept tributary drainage areas.

- Construction phase performance goal is to reduce the total suspended solids by 80 percent for the 10-year, 24-hour storm, or provide a detention time of 24 to 48 hours for the 10-year, 24-hour storm.
- Minimum drainage area is 5 acres; the maximum drainage area is 120 acres.
- Basin flow length should be at least two times the flow width; the longer, the better. Baffles constructed of filter fabric and metal posts can be used inside the basin to create a longer (e.g., serpentine) flow path between inlet(s) and the outlet.
- Construct the basin before clearing and grading work begins.
- Basins, side slopes, berms, inlets, and downstream outlet channels must be seeded and mulched or blanketed immediately after construction.
- Basins that drain more than 10 acres can be designed as retention (rather than detention) basins (i.e., *wet ponds*). Design outlet to drain top of the pool farthest away from muddy inflows. Incorporating a sediment collection forebay is recommended to aid in maintenance.

Embankment requirements

- Dam height should not exceed 20 feet
- Maximum inside and outside slopes of the dam must be 3H:1V
- Minimum 1 foot freeboard during the 100-year, 6-hour storm
- Antiseep collars around discharge pipe are required
- Minimum top width of the dam must be 12 feet

Principal spillway (riser and barrel) requirements

Use a subsurface drain, a solid riser pipe, or both, with sufficient dewatering holes to provide sufficient detention time. Risers with one-half inch holes every 3 to 6 inches apart are recommended.

- No large holes or slots should appear in the lower two-thirds of the riser. Risers with large openings can be modified as described below or wrapped with filter fabric to cover lower openings during the construction period.
- During construction, risers should be modified with an inlet protection dike, pile of stone at the riser base, or other structure to provide longer ponding times (e.g., 1-2 days) for small flow events.
- Operational design goal is to reduce the peak flow to predevelopment levels for the 2-year and 10-year, 24-hour storms.
- Minimum diameter of pipe outlet is 12 inches; anti-vortex baffle and trash rack are required
- Minimum one foot freeboard required from top of riser to crest of emergency spillway

KY Division of Water Dam Safety Requirements

The sediment basin might have to be designed in accordance with dam safety requirements of the KY Division of Water. A dam is defined as any impounding structure that is either 25 feet in height, measured from the downstream toe to the crest, or has a maximum impounding capacity of 50 acre-feet of water. Structures that do not meet these criteria but have the potential to cause significant property damage or pose a threat to loss of life in the downstream area are regulated in the same manner as dams.

Emergency spillway requirements

- Designed to pass the 100-year, 6-hour post development peak flow
- Crest elevation at least one foot above the tip of the riser pipe
- Minimum one foot freeboard during the 100-year, 6-hour storm to the top of the embankment
- Rock used for the emergency spillway must be KYTC No. 2 or larger, depending on flow volumes and spillway slope (see sections on rock-lined channels and outlet stabilization energy dissipator)
- Emergency spillway energy dissipator must be extended at least 4 feet beyond the toe of the dam

Construction Specifications

- Construct the basin by excavating or building an embankment dike before any clearing or grading work begins.
- Areas under the embankment and any structural works must be cleared, grubbed and stripped of any vegetation and rootmat as shown on the erosion and sediment control plan.
- To facilitate cleanout and restoration, the basin area must be cleared, grubbed and stripped of any vegetation.
- A cut-off trench must be excavated along the centerline of the earth fill embankments. The minimum depth must be 2 feet. The cut-off trench must extend up both abutments to the riser crest elevation.
- Fill material for the embankment must be clean, low-permeability, mineral soil free of roots, woody vegetation, oversized stones, rocks, or other objectionable material.
- Fill material must be placed in 6 inch lifts, continuous layers over the entire length of the fill. Compacting must be obtained by routing the hauling equipment over the fill so that the entire surface of each layer of the fill is traversed by at least one wheel or tread track of the equipment or by the use of a compactor. Each layer must be compacted to 95 percent of maximum density and +/- 2 percent of optimum moisture content.
- The embankment should be constructed to an elevation of 10 percent higher than the design height to allow for settlement if compacting is achieved with hauling equipment. If compactors are used for compacting, the overbuild may be reduced to not less than 5 percent.
- The principle spillway riser must be securely attached to the discharge pipe by welding all around. All connections must be watertight.
- The pipe and riser must be placed on a firm, smooth soil foundation. The connection between the riser, and the riser base must be watertight. Pervious materials such as sand, gravel, or crushed stone must not be used as backfill around the pipe or anti-seep collars.
- The fill material around the pipe spillway must be placed in 4-inch layers and compacted under the shoulders and around the pipe to at least the same density as the adjacent embankment. A minimum of 2 feet of compacted backfill must be placed over the pipe spillway before crossing it with construction equipment.
- Risers might require a rock berm or other flow restrictor during the construction phase to ensure that muddy flows are detained sufficiently to promote settling of sediment.

- Steel base plates must have at least 2.5 feet of compacted earth, stone, or gravel over them to prevent flotation.
- An emergency spillway is required, and must not be installed in fill. Appropriate overflow channel lining and energy dissipator must be constructed.
- Baffles, if used, must be constructed of 4 inch by 4 inch posts and of 4 foot by 8 foot half-inch exterior plywood. The posts must be set at least 3 feet into the ground, no farther apart than 8 feet center to center, and must reach a height 6 inches below the riser crest elevation. Silt fencing with metal posts can also be used if flow velocities in the basin are low and ponding heights during the 2-year, 24-hour storm will not exceed 5 feet.
- The embankment, emergency spillway, incoming channels, and other site features must be stabilized with vegetation and mulched or blanketed immediately following construction.
- Construction operations must be carried out in such a manner that erosion and water pollution will be minimized.
- Local and state requirements must be met concerning fencing and signs warning the public of hazards of soft sediment and floodwater.

Inspection and Maintenance

Inspect the sediment basin weekly and after each rainfall greater than one-half inch. If incoming flows are exiting the basin quickly because of large holes in the outlet, modify the lower portion of the riser with a stone berm, filter fabric, or other flow restrictor that retains incoming flows for at least 12–24 hours.

- All damages caused by soil erosion or construction equipment must be repaired before the end of each working day.
- Remove sediment when the sediment storage zone is half full. This sediment must be placed in such a manner that it will not erode from the site. The sediment must not be deposited downstream from the embankment or in or adjacent to a stream or floodplain.
- When temporary structures have served their intended purpose and the contributing drainage area has been properly stabilized, the embankment and resulting sediment deposit must be leveled or otherwise disposed of according to the approved erosion and sediment control plan.
- If the sediment basin is designed to function as a permanent stormwater treatment pond, the basin and riser will be configured to that mode upon stabilization of the upland drainage area. Temporary flow restrictors on risers and other construction phase modifications must be removed.



This is a well-constructed sediment basin. Note the rock flow restrictor around outlet riser, which filters and detains inflows. Basin sidewalls should be seeded immediately after construction.



For best results, seed basin sidewalls and upland drainage areas as soon as possible. Make sure outlet structure does not allow rapid flow through the basin—use a rock berm, filter fabric, or other means to maximize ponding and detention time.



The flow path through this basin has been lengthened by using filter fabric baffles constructed to create a serpentine flow path. Note the rock pile around outlet riser to maximize detention and grass on sidewalls.



This outlet riser intake hole has been modified with a “half round” section of pipe with 1-inch holes on 6-inch centers and rock berm. This temporary dike provides additional detention during the construction phase, which improves soil removal.

This shows a very well designed detention basin, featuring long flow path between inlet and outlet and V-notched outlet riser, which provides longer detention times for low flow events while still accommodating larger storms. Operation of this basin during the construction phase, however, is very poor. Note the lack of grass on sidewalls; no temporary dike in front of the outlet. This basin appears to be filling rapidly and requires sediment removal. For best results, seed and mulch basins immediately after construction, and modify the outlet to achieve 1 to 2 days of drain-down time after storm events.



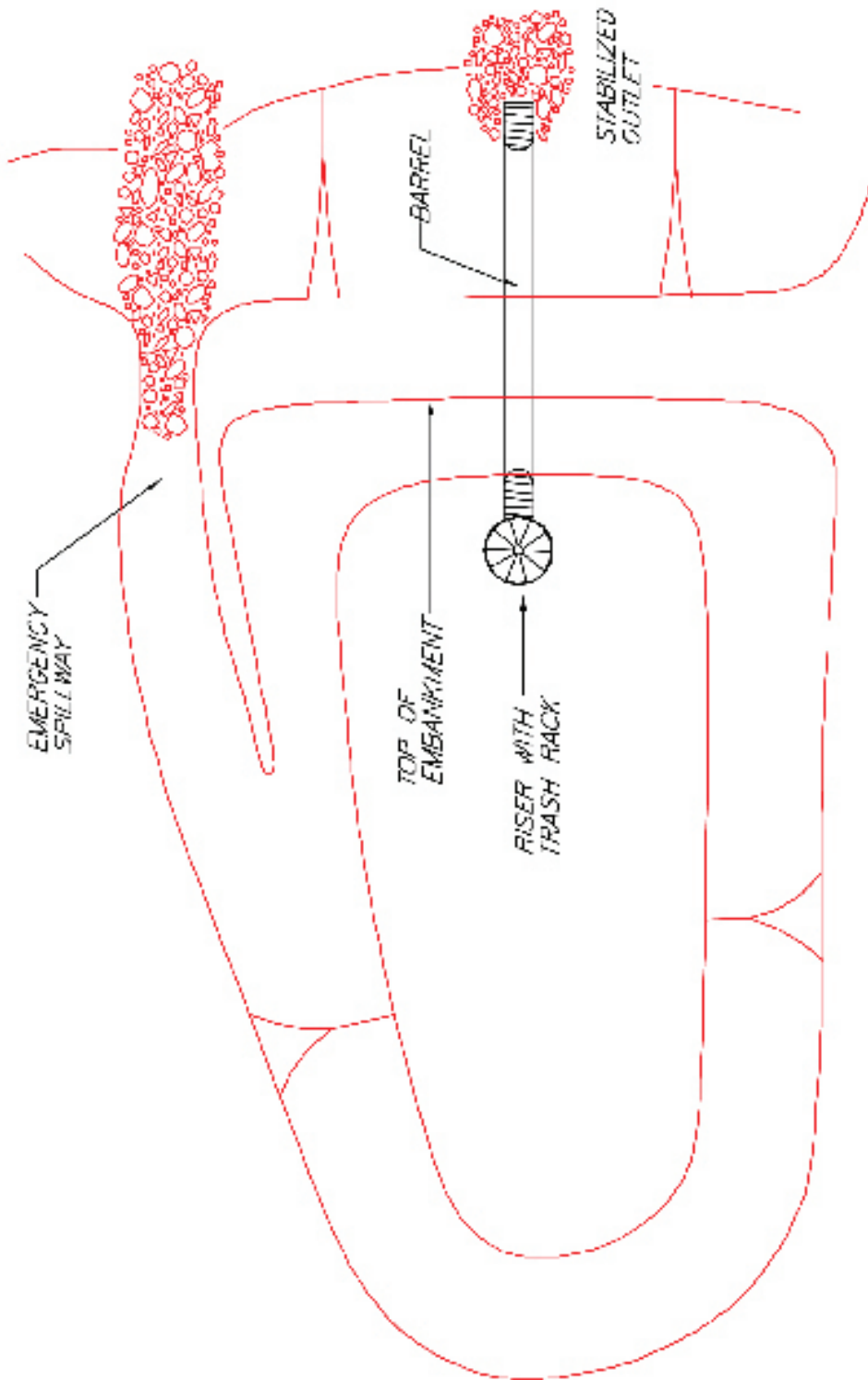

NOTE:
A SEDIMENT BASIN IS REQUIRED FOR DISTURBED AREAS GREATER THAN 10 ACRES

PLAN

**SEDIMENT
BASIN**

SOURCE: SALIX APPLIED EARTHCARE -
EROSION DRAW 5.0

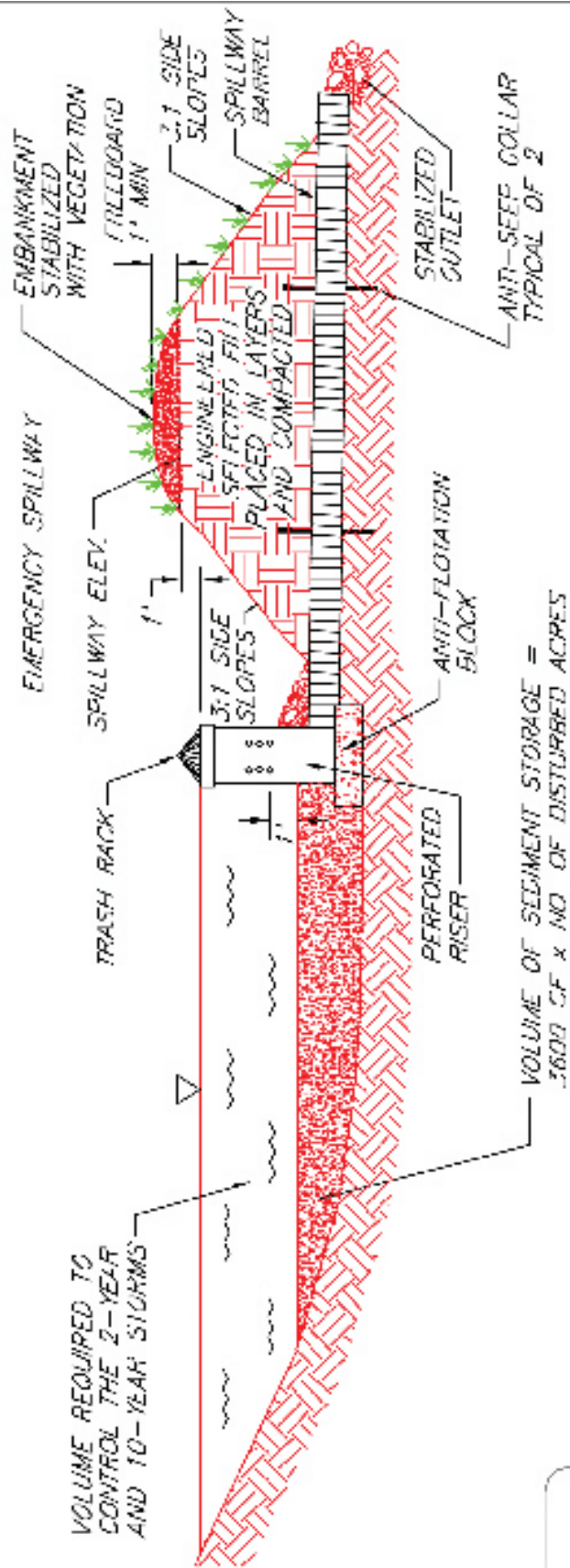

VOLUME REQUIRED TO CONTROL THE 2-YEAR AND 10-YEAR STORMS

VOLUME OF SEDIMENT STORAGE = 1600 CF x NO OF DISTURBED ACRES

NOTE:
 4 SEDIMENT BASIN IS REQUIRED FOR DISTURBED AREAS GREATER THAN 10 ACRES.

SEDIMENT BASIN

SECTION

SOURCE: SALIX APPLIED EARTHCARE - EROSION DRAW 5.0

4.7 Sediment Traps and Basins

4.7.3 Dewatering Devices



This shows a dewatering sediment filter bag (center) in use at residential construction site. Muddy water pumped into the bag is physically filtered, with clear water passing through the bag fabric. Pumping muddy, unfiltered water directly into curb drains (center left) or surface streams constitutes a direct KPDES permit violation.



Definition

Dewatering is the pumping of stormwater or groundwater from excavation pits or trenches. The sediment-laden water must be pumped to a dewatering structure for sediment removal before it is discharged off-site.

Purpose

The purpose of a dewatering device is to remove sediment from the water before it is discharged off-site.

Design Criteria

Dewatering operations should not discharge to a ditch, pipe, or other conveyance that leads to a regulated water body (e.g., stream, river, wetland, lake) except as authorized by a KPDES permit. (Note: The KPDES Construction General Permit covers dewatering discharges to surface waters or ditches leading to surface waters as long as all Permit conditions are met).

There are several types of dewatering structures or devices that can be used. A flat, well-stabilized, vegetated area can serve as a filtering *structure* if it can withstand the velocity of the discharged water and infiltrate or assimilate it without erosion. The minimum filter radius or length must be at least 75 feet.

It is recommended that sediment basins or temporary sediment traps receive sediment-laden water from bore pits and trenches. This will ensure that the 80 percent trapping efficiency goal will be upheld. Take special care to ensure that pumping this water does not cause the sediment control structure to fail. Also take care at the outlet of the hose from the pump to ensure that erosion does not occur because of high concentrated flows.

Another option is to use an infiltration trench—a shallow, excavated trench back-filled with stone—to form a reservoir. This reservoir can contain subsurface drainage pipe or just stone. This trench allows water to filter through the stone and then be diverted to a suitable discharge point. The soils and the depth to the water table must be suitable for this sort of dewatering. Typical trench depths range from 2 to 8 feet. The stone fill material consists of washed aggregate 1.5 to 3 inches in diameter.

Other methods that can be used include a portable sediment tank, a silt fence pit, or a commercial sediment filter bag or *sock*. The structure must be sized to allow pumped water to flow through the structure without overtopping.

If possible, fill excavations that are not being actively worked to prevent them from becoming ponded deeply with muddy water that must be pumped.

Construction Specifications

See the specifications in this manual for sediment traps and basins. Follow the manufacturer's recommendations for commercial products.

Inspection and Maintenance

Inspect the dewatering structure or device frequently to ensure that it is functioning properly and not overflowing. Accumulated sediment should be spread out on site and stabilized, or disposed of off-site.

Silt fence enclosures and commercial sediment filters will likely require cleaning to remove fine particles and restore performance. This can be done with a stiff brush when the filter is dry, or via other manufacturer's recommendations.

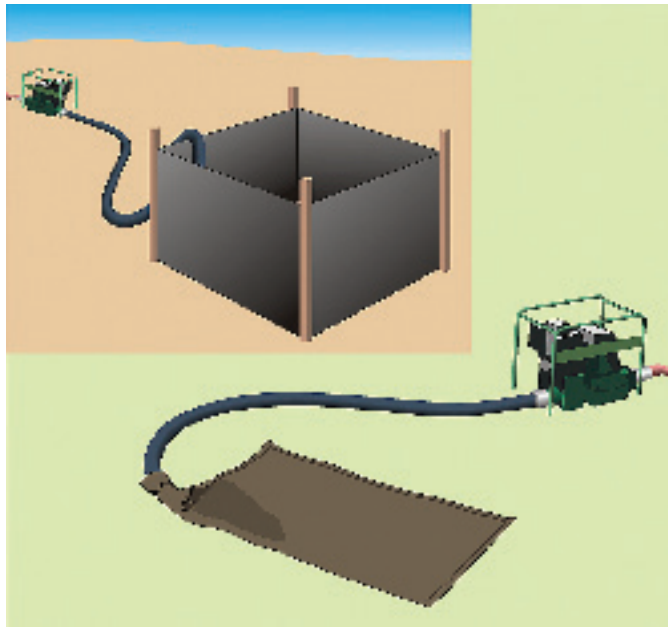

Containment structures for sediment-laden water can be made of rock or filter fabric. Standard notes should require monitoring to make sure the containment structure is not breached during dewatering operations.



Large bags or socks made of filter fabric provide excellent sediment removal and are extremely versatile. Site filtration structures away from surface waters if possible. Dispose of sediment collected in a flat vegetated area or other site where it will not wash into surface waters.



Large sediment filter bag in operation. Note the row of straw bales around the bag providing additional treatment for clarified flow oozing out of the bag. A silt fence could also be used.

When dewatering sediment or other ponds, wait until several days after the last rain if possible to allow for settling of sediments. Pump from the upper portion of pond, where water is clearer.



4.8 Stream and Wetland Protection

General Information

All streams, rivers, lakes, and wetlands are regulated waters in Kentucky. In addition, most small upland drainageways that carry flowing water during part of the year are also regulated, and activities that affect sinkholes and other karst features may be subject to regulatory oversight for certain activities.

No construction activities should occur within 25 ft. of the banks or within the channels of these waterways without specific permit coverage provided by the USACE and the KYDOW. This includes activities such as clearing vegetation from streambanks, placing culverts or temporary creek crossings, channelizing or straightening streams, filling wetlands with soil, or placing dams or sediment barriers across streams. **Disturbed areas within 25 ft. of stream banks (i.e., bank full elevation) must be stabilized within 24 hours.**

The best approach for dealing with streams, wetlands, and other water bodies on construction sites is to designate them and their 25 ft. vegetated buffers as *do not disturb* zones by flagging them off-limits for vehicles and equipment. This can be done on construction plans by designating these areas as *buffer zones*—see the fact sheet that follows for additional information.

Construction activities that seek to stabilize or restore damaged streambanks can use the other fact sheets in this section for information on vegetative practices. These are often accompanied structural measures such as gabion baskets/mattresses, turf reinforcement mats, and rock (see fact sheets on those topics).

Small stabilization or restoration projects can follow the information in the fact sheets for guidance on how to proceed with structural or vegetative approaches. Larger projects involving significant stream channel work (i.e., ≥ 200 feet) should be based on stream geomorphological and flow analyses to ensure that vegetative and structural installations are not washed out.



Vegetative measures—armored with permanent turf reinforcement mats or geogrid structures—are preferred over riprap for restoring or stabilizing stream banks. All work within stream channels and wetlands requires permit coverage by the USACE and the KYDOW.

Plan sheets and work orders for projects near streams and wetlands should specify the posting of “do not mow” warning signs along vegetated buffer areas. Flagging buffer zones during construction helps keep equipment away from areas where violations of federal or state clean water rules might occur.



Trees, Shrubs, and Herbaceous Vegetation for Streams and Wetlands

Use native species for vegetated areas, landscaping, and stream or wetland buffer areas wherever possible. Native species can provide year-round attractive scenery, important habitat, pollutant buffering, and structural stability for soils. Native trees and shrubs are adapted to Kentucky's climate and will not need as much care and maintenance as ornamentals or nonnatives. In addition, prices for native species are often as low or lower than other landscaping plant material.

For best results, protect soils where trees and shrubs will be planted by marking off areas and restricting equipment movement and resulting soil compaction. Compacted soils, low soil organic matter, and low fertility might require soil amendments and preparation before planting. Use species from the list below, or consult local UK Extension Service or Natural Resources Conservation Service (NRCS) offices for more information. The species below are suggested for planting along creek banks, lake shores, rivers, wetlands, and other riparian areas.

Suggested Vegetation for Stream Buffer Areas

| Tree | Species |
|--------------------|------------------------------------|
| Pin Oak | <i>Quercus palustris</i> |
| Cherrybark Oak | <i>Quercus pagoda</i> |
| Bur Oak | <i>Quercus macrocarpa</i> |
| Swamp Chestnut Oak | <i>Quercus michauxii</i> |
| Shingle Oak | <i>Quercus imbricaria</i> |
| Northern Red Oak | <i>Quercus rubra</i> |
| Post Oak | <i>Quercus stellata</i> |
| Red Maple | <i>Acer rubrum</i> |
| Green Ash | <i>Fraxinus pennsylvanica</i> |
| Shellbark Hickory | <i>Carya laciniosa</i> |
| Blackgum | <i>Nyssa sylvatica</i> |
| American Elm | <i>Ulmus americana</i> |
| Eastern Cottonwood | <i>Populus deltoides</i> |
| Black Walnut | <i>Juglans nigra</i> |
| River Birch | <i>Betula nigra</i> |
| Yellow Poplar | <i>Liriodendron tulipifera</i> |
| Persimmon | <i>Diospyrus virginiana</i> |
| Shrubs | |
| Arrow-wood | <i>Viburnum dentatum</i> |
| American Plum | <i>Prunus americana</i> |
| Deciduous Holly | <i>Ilex decidua</i> |
| Gray Dogwood | <i>Cornus racemosa</i> |
| Silky Dogwood | <i>Cornus amomun</i> |
| Spicebush | <i>Lindera benzoin</i> |
| Sassafras | <i>Sassafras albinum</i> |
| Herbaceous Plants | |
| Rice Cutgrass | <i>Leersia oryzoides</i> |
| Managrass | <i>Glyceria striata</i> |
| Spangle Grass | <i>Chasmanthium latifolium</i> |
| Barnyard Grass | <i>Echinochloa crus-galli</i> |
| Switchgrass | <i>Panicum virgatum</i> |
| Annual Rye | <i>Secale cereale</i> |
| Wild Rye | <i>Elymus virginicus</i> |
| Deertongue Grass | <i>Panicum clandestinum</i> |
| Panic Grass | <i>Panicum microcarpon</i> |
| Kentucky Cane | <i>Bamboo Arundinaria gigantea</i> |

4.8 Stream and Wetland Protection

4.8.1 Buffer Zones



Stream buffer zones can be enhanced with plantings of native trees and shrubs, which also help to stabilize banks and mediate erosive scour forces. Permanent TRMs, geogrid structures, or rock can be used to provide supplemental armoring. Kentucky requires a minimum 25 ft. buffer for all streams, lakes, rivers, wetlands, and sinkholes. An adequately protective alternative practice can be used if it is not possible to meet the setback requirement, such as with bridge construction.



Definition

Buffer zones are setback requirements that establish 25 to 50 ft. no-disturbance protection zones along and around streams, wetlands, rivers, ponds, and lakes.

Purpose

The purpose of a buffer zone or setback is to restrict activities near waterways and to maintain a vegetative buffer strip so that soil disturbance is avoided and waterways retain the natural filtration, structural protection, and infiltration capacity offered by natural vegetated buffers.

Design Criteria

Site plans should specify buffer zones along existing site drainage features such as upland swales, ditches, intermittent and ephemeral (i.e., flowing only after rains or during snowmelt) and streams, ponds, wetlands, sinkholes, lakes, and rivers. Establishing buffer zones along existing drainage features preserves the drainage system, which promotes greater site stability, less erosion, higher aesthetic potential, increased habitat value, and more economical site development.

Site development design should attempt to *lay in* desired structures such as buildings, roads, utilities, and so forth with minimal disturbance to the existing drainage system and its adjacent vegetated buffer zone. Where this is not possible, site plans can specify that newly constructed drainage features be vegetated with native material, with new buffer zones established around the new drainage system (see the Vegetated Buffer section).

Some jurisdictions have mandatory setback requirements regarding limits of disturbance near water bodies and karst features. Check with the local planning and zoning office before working near waterways. Recommended setbacks from waterways are shown in the table on the following page.

Zones for a Vegetated Stream Buffer

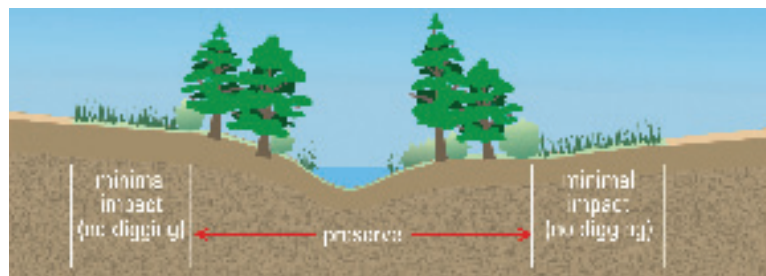

Buffer zone widths vary according to stream size. In general, the near-bank area (25–50 ft for streams, 50–100 ft for rivers) should contain an undisturbed mix of native trees, shrubs, and herbaceous vegetation. The upgradient secondary buffer zone can be managed as mowed grass or hay land, or planted with no-mow native grasses.

Recommended Setbacks From Top of the Streambank or Lakeshore

| Bank Slope | Soil Type Along Banks | | |
|------------------------------|-----------------------|-------|-------|
| | Sandy | Silty | Clays |
| Very Steep (2:1 or more) | 100 ft | 80 ft | 60 ft |
| Steep (4:1 or more) | 80 ft | 60 ft | 40 ft |
| Moderate (6:1 or more) | 60 ft | 40 ft | 30 ft |
| Mostly Flat (less than 10:1) | 40 ft | 30 ft | 25 ft |

Construction Specifications

See the section on Vegetated Filter Strips (next) in this manual.

Inspection and Maintenance

See the section on Vegetated Filter Strips (next) in this manual.

Kentucky regulations require an undisturbed 25 ft buffer for all surface waters. Buffer width is 50ft for waters impaired for sediment with no TMDL.



Vegetated buffers provide excellent protection against sediment from muddy sheet flows. Control of concentrated flows of runoff through the buffer is also required.

Native trees and shrubs can resist scour forces that cause streambank and lakeshore erosion. Management of these areas should include only removal of invasive species.



Kentucky cane (*Arundinaria gigantea*, above) and other native grasses can slow down and filter sediment runoff. Buffers that are too narrow (right) offer little protection against high water bank erosion.



4.8 Stream and Wetland Protection

4.8.2 Filter Strips



Vegetated filter strips can be designed into projects as attractive natural areas, with showy wildflowers and interesting fall colors. These amenities are in addition to the important functions of intercepting, filtering, and processing contaminants in storm runoff.

Definition

A filter strip is a planted strip of native grasses or other vegetation adjacent to and upgradient from a drainage ditch, stormwater system inlet, or natural water body such as a stream, river, lake, wetland, or sinkhole. They can also be used to protect lawns and paved areas. Filter strips are typically managed as a *natural* vegetative filter rather than mowed turf grass.

Purpose

The purpose of a vegetated filter strip is to act as a natural, vegetated buffer (see the Buffer Zone section) in reducing the amount of sediment in incoming runoff, the velocity of the runoff, and the temperature of the runoff during hot weather. Vegetated filter strips promote stormwater infiltration, deposition of sediment, absorption of other pollutants, and decomposition of organics to reduce or assimilate pollutants in the runoff.

Vegetated Filter Strip Width Recommendations for Kentucky

| Stream Type | Conditions | Minimum Buffer Width | General Considerations |
|-----------------------------------|--|----------------------|--|
| Urban streams | > 25% imperviousness in drainage area | 25 ft each bank | At least two-thirds of the buffer—nearest to the water—should be undisturbed native or natural vegetation. |
| Suburban streams | 10% to 25% imperviousness in drainage area | 50 ft each bank | |
| Rural streams | < 10% imperviousness in drainage area | ≥ 60 ft each bank | Remainder can be permanent managed vegetation. |
| Large rivers | Rivers with floodplains > 500 ft wide | ≥ 100 ft each bank | |
| Wetlands | For sloping sites, add more buffer | 25 to 50 ft | Avoid turf grass in managed area if possible; use native grasses, wildflower mixes. Mow annually or less. |
| Sinkholes or other karst features | Will vary according to size and flow characteristics | 25 to 50 ft radius | |

Design Criteria

Filter strips should be used only to address potential water quality problems associated with overland (sheet) flow. They are not effective in removing sediment from concentrated flows unless those flows are dispersed on flat ground before discharge into the filter strip.

- Vegetative filter strips cannot be expected to remove all sediment or adequately protect adjacent areas from sediment damage when used alone. Vegetative filters should be considered only as one component of the erosion and sediment control system.
- If vegetative filter strips are proposed as a sediment control device and they do not already exist, they must be planned and established before initiating general land-disturbing activities if possible.
- Minimum filter strip width should be 25 feet for urban streams, 50–75 feet for suburban and rural streams, and at least 100 feet for large rivers. Plans should show the location, width, and length of filter strips. The type of vegetation and specifications for soil preparation and seeding must be included. If existing vegetation is to be used, plans for protecting or improving it must be provided.
- The width of filter strips expected to treat runoff from long slopes should be at least one-fourth the length of the slope for slopes up to 20 percent and at least half the slope length for steeper areas.

Material Specifications

When establishing new seeded areas, consideration must be given to aesthetics and wildlife needs and soil conditions on the site. Native grass and wildflower mixtures are attractive, commercially available, and can be seeded with standard equipment for the most part.

- It is easier and cheaper to protect and preserve existing areas than to establish new ones. Existing grass wildflower, or grass/legume areas to be used as filter strips should be flagged off as a *buffer zone* (see the Buffer Zone section). Equipment and vehicular traffic in these areas should be restricted to avoid damage to vegetation. Vegetation should be dense and well established with no bare spots.
- Seed species for native grass and wildflower mixes are available from county extension and NRCS offices. Specify quality seed mixtures selected on the basis of climate, soils, drainage, shading, and other factors. Note that taller grass mixtures might not be appropriate near residential areas because of security concerns regarding visibility.
- Specify planting of grasses and forbs at the same time. Seeding rates will vary by species, but should generally be specialized and low, unlike agricultural seeding rates. Consider a cover/nursery crop of annual or short-lived native species (e.g., rye) to protect the site until grasses and wildflowers emerge.
- Seed should be from current production, no more than one year old, and free of mold or insects and disease. Seed origin should be furnished and have characteristics similar to the site. Seed collected or grown in the region is usually best.

The following chart provides a list of alternative grass and grass/legume mixtures for projects not using other native grass/wildflower mixes:

Filter Strip Seeding Mixture and Site Suitability Chart

| Seeding Mixture | Seeding Rate Lbs/Acre | Soil Suitability |
|--|--------------------------|---------------------|
| 1. Alfalfa or Red Clover Plus Timothy or Orchardgrass or Bromegrass | 10 10 4 6 6 | Well Drained |
| 2. Ladino Clover Plus Timothy or Orchardgrass or Bromegrass | ½ 4 6 8 | Wet or Well Drained |
| 3. Tall Fescue | 40 | Wet or Well Drained |
| 4. Reed Canarygrass Plus Tall Fescue | 15 10 | Wet |

Construction Specifications

When planting filter strips, prepare the seedbed, incorporate fertilizer (if necessary), and apply mulch consistent with the seeding sections of this manual. Filter strips using areas of existing vegetation must be overseeded, as necessary, with the above mixtures to obtain an equivalent density of vegetation. The over seeding must be accomplished before the land disturbing activity if no grading will occur in the area. See the Permanent Seeding section of this manual for further details. For areas to be seeded in native grass and wildflower mixes, use the following approach:

Vegetation removal before seeding—If undesirable vegetation exists on the site, kill with nonselective, nonresidual herbicide, a glyphosate without surfactant if possible. After evidence of kill (7–14 days) mow to 2 inches. Mow or rake off.

Avoid soil disturbance—Avoid deep tillage, which pulls up new weed seed to compromise plantings. Scarify soil no deeper than one-half inch, on the contour, to reduce weed and erosion problems. No-till planters are now available to plant into existing dead stubble. Avoid adding imported topsoils unless it is certified to be weed-free.

Soil amendments—Amendments should be limited because of stream contamination and cost concerns. Fertilizers assist weed growth and can leach into surface waters. Native forbs and grasses, if matched to the site, should establish without fertilizers if moisture is available. Amendments, if used, should be monitored for potential runoff impacts. Addition of peat moss has not proven beneficial to these plantings over time. Addition of native mycorrhizae has proven beneficial.

Equipment—Follow the seed distributor’s instructions for planting. Specialized drills, broadcasters, and hydroseeders are available. Choose carefully and experiment on small areas to determine the best approach. The bottom line is that the seed germinates only if it makes contact with the soil and moisture.

Follow-up—Cover the seed by harrowing, dragging, raking or cultipacking. Mulch with weed-free straw or hay or native grass straw. Use ECBs on long, steep slopes if mulch and netting will not suffice. Avoid irrigation unless experiencing periods of drought, when supplementary watering might be in order. A high (6–8 inches) mowing once or twice during the first season reduces weed competition.

Inspection and Maintenance

Inspect filter strips regularly to ensure that a healthy vegetative growth is maintained. Any bare spots or spots where sediment deposition could lead to the destruction of vegetation must be repaired.

If necessary, filter strips must be fertilized once each year in the fall. Construction traffic must not be permitted to drive upon filter strips.

Filter strips should be managed as natural type vegetated areas, with an annual or biennial mowing regimen (typically mowed during the fall), regular litter removal if needed, and reseeding of vegetation where necessary.



These are good examples of vegetated filter strips along a small swale (left) and large stream (below). Protect these areas during construction with flagging ribbon or signs.



Filter strips along lakes and ponds (left) can include mowed access areas for fishing and other activities. Where severe scour forces are present, protect planted filter strips with turf reinforcement mats or other armoring to prevent bank erosion (below).



4.8 Stream and Wetland Protection

4.8.3 Temporary Stream Crossing



Temporary stream crossings require a USACE Clean Water Act section 404 permit. Avoid or minimize removal of vegetation and excavation at the crossing site. Cover all bare soil areas with straw or ECBs. Cover the approaches on both sides (25 ft minimum) with No. 2 stone.

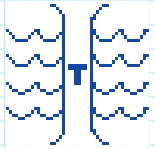

Definition

A temporary stream crossing is a temporary structural span installed across a flowing stream use by construction traffic. Structures can include bridges, round pipes, or pipe arches.

Purpose

The purpose of a temporary stream crossing is to provide a means for construction traffic to cross flowing streams without damaging the channel or banks and to keep sediment generated by construction traffic out of the stream.

Design Criteria

Temporary stream crossings are applicable to flowing streams with drainage areas less than one square mile. Structures that must handle flow from larger drainage areas must be designed by a licensed professional engineer.

- Temporary stream crossings must be planned to be in service for the shortest practical period of time and to be removed as soon as their function is completed. Choose crossing sites at straight channel sections (i.e., riffles or glides, not pools) with stable banks and channel bottoms if possible. Avoid areas where trees will need to be removed.
- Such structures are subject to the rules and regulations of the USACE for in-stream modifications (404 permits) and the KYDOW (401 certification).
- The span must be designed to withstand the expected loads from heavy construction equipment that will cross the structure.
- The structure must be large enough to convey the peak flow expected from a 2-year, 24-hour storm without appreciably altering the stream flow characteristics. The structure may be a span, a culvert, or multiple culverts.
- Where culverts are installed, rock must be used to form the crossing (i.e., not soil). The depth of the rock cover over the culvert must be equal to one-half the diameter of the culvert or 12 inches, whichever is greater. The area around the crossing must be protected from erosion using the mulching and seeding erosion control measures specified in this manual. The slope of the culvert must be at least one-quarter inch per foot.

- The approaches to the crossing structure must consist of stone pads at least 25 feet in length also covered with KYTC No. 2 stone.
- Crossing structures can be bridges or culverts/pipes of any material that can support the fully loaded equipment expected. The minimum sized culvert must be 24 inches.

Construction Specifications

- Clearing and excavation of the streambed and banks must be minimized. Do not grade and grub the site. For best results, remove by hand or chainsaw only the vegetation growing within the approach pads and crossing area. Place pipe or structure at the crossing location, and place rock on approach pads and crossing pipe/structure.
- The approaches to the structure must consist of stone pads with a minimum thickness of 6 inches, a minimum width equal to the width of the structure and a minimum approach length of 25 feet on each side.

Inspection and Maintenance

- The structure must be inspected after every rainfall greater than one-half inch and at least once a week. Repair all damages immediately.
- The structure must be removed as soon as it is no longer necessary for project construction. Take care during removal not to damage shrubs, trees, and other vegetation that was left intact when the crossing was built.
- Upon removal of the structure, the stream must immediately be restored to its original cross-section and properly stabilized with vegetation, mulch, ECBs, or TRMs as necessary.



Here are several poor temporary crossing examples (above, and below right). Temporary crossing areas should not be grubbed and stripped if possible. Bare soil areas should be covered with straw or ECBs (top right).



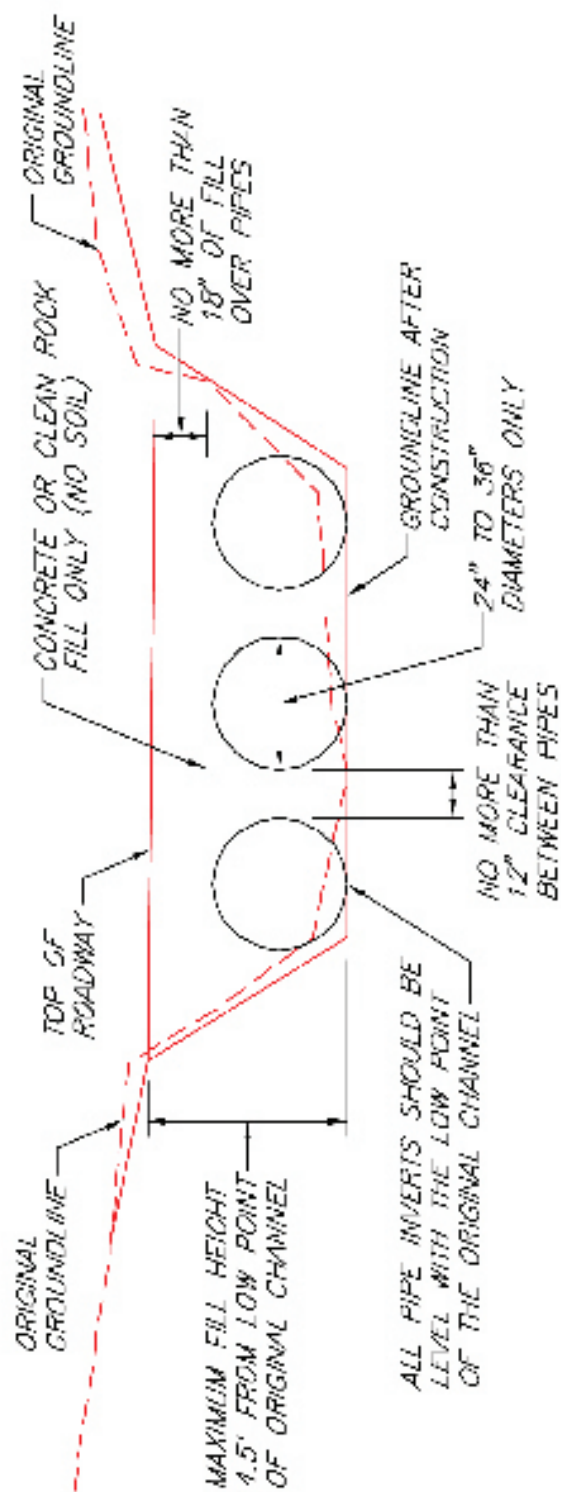

NOTES

1. THIS IS A CONCEPTUAL DRAWING. THE NUMBER AND SIZE OF PIPES AND OTHER DETAILS WILL VARY DEPENDING ON SPECIFIC SITE CONDITIONS.
2. THE PIPES AND BACKFILL MUST BE CONTAINED WITHIN THE STREAM CHANNEL AS SHOWN ABOVE. DURING THE CONSTRUCTION OF THE APPROACHES AND ACCESS ROADWAYS ACROSS THE FLOODPLAIN, UNSTABLE AND UNCONSOLIDATED MATERIALS UNSUITABLE FOR ROADWAYS MAY BE EXCAVATED AND REPLACED WITH RIPRAP, CRUSHED STONE, OR OTHER STABLE ROAD CONSTRUCTION MATERIALS. THIS MAY ONLY BE DONE, HOWEVER, WITH THE FOLLOWING PROVISIONS: (1) THE DISPOSAL OF EXCESS, UNCONSOLIDATED MATERIALS MUST BE OUTSIDE OF THE FLOODPLAIN AND (2) THE FINISHED SURFACE OF THE COMPLETED ROAD MAY BE NO MORE THAN THREE INCHES (3") ABOVE THE PRE CONSTRUCTION SURFACE OF THE FLOODPLAIN AT ANY POINT BEYOND THE TOP OF BANKS.

STREAM CROSSING

**KY DIVISION OF WATER
LOW-WATER CROSSING**

4.8 Stream and Wetland Protection

4.8.4 Bioengineering: Live Staking



Live stakes (center) of willow or other selected hardwoods can be cut during the dormant season and driven into stream banks or shore areas to stabilize erodible soils. Note that some hardwood species require special preparation to ensure growth. All species require contact with moist soil along the lower portions of the live stake.



Definition

Live stake planting involves inserting and tamping live, rootable vegetative tree or shrub cuttings (e.g., willow, ash, alder) into moist streambanks in a manner that allows the stake to take root and grow.

Purpose

Live stakes create a root mat that stabilizes the soil by reinforcing and binding soil particles together and by extracting excess soil moisture. Growing stakes also provide physical armoring of streambanks against high-velocity flows. This practice is commonly used in conjunction with other practices to provide for a more stable site condition (i.e., used to anchor blankets, coir mats, TRMs, straw rolls). Live stakes can be used for the following:

- Repair of small earth slips and slumps.
- Gullies and stream channels can be live-staked. Areas best suited to staking are the bottoms and banks of small gullies and bare gully banks.
- Live stakes can be inserted or driven through interstices or openings in gabions, riprap, articulated block, or cellular confinement systems.

Vegetative Streambank Stabilization

Vegetative streambank stabilization, also known as bioengineering, includes a variety of measures designed to reduce erosion by installing protective vegetation and a few strategically placed structural components such as ECBs, TRMs, geotextiles, tree roots, and other materials.

Vegetative streambank stabilization can incorporate significant structural components such as gabion baskets and mattresses, slope toe protection rock, and cellular geogrid applications. However, the focus for this BMP is to minimize the appearance of so-called “hard armoring” such as rock and gabions and to maximize the “soft look” of trees, shrubs, and other vegetation. The selection, installation, and maintenance of vegetative material is the key to success.

All streambank stabilization practices, structural and vegetative, are subject to Clean Water Act section 404 permit coverage issued by the USACE and KYDOW Clean Water Act section 401 Water Quality Certification and Floodplain Permits.

- Live willow stakes can be used to anchor and enhance the effectiveness of willow wattles, straw rolls, coir rolls, turf reinforcement mats, coir mats, and other erosion control materials.
- Willow staking enhances conditions for natural invasion and the establishment of other plants from the surrounding plant community.
- Willow establishment can improve aesthetics and provide wildlife habitat.
- As a temporary measure, live willow staking performs an important function of stabilizing and modifying the soil, serving as a pioneer species until other plants become established.
- Several species of willow will grow from cuttings in less favorable soil conditions such as road fills and gullies in bare denuded land. Even in very unfavorable sites willow cuttings will often grow vigorously for a few years before they die out.

Design Criteria

Willows have several different growth forms, from shrubs to large trees. Small- to medium-sized, shrub-type and rhizomatous or creeping-type willows are used for planting channel banks. Upland willow species are found in relatively dry areas and should be used on similar sites. Tree-type willows are selected for the upper bank and floodplain area.

Live stakes can be specified for streambanks with slopes of 3H:1V or flatter. Steeper slopes will require grooving or benching and ECBs that can withstand expected shear stresses. The following table shows recorded shear stress withstood by live staking.

Bank Materials and Shear Stress Limits (Live Stakes)

| Bank Material | Shear (lb/ft ²) |
|---|-----------------------------|
| Live stakes in riprap (immediately after construction) | 2.04 |
| Live stakes in riprap (after 3–4 seasons) | 6.12 |
| Coarse gravel and stone cover with live cuttings (immediately after construction) | 1.02 |
| Coarse gravel and stone cover with live cuttings (after 3–4 seasons) | 5.1 |
| Willow cuttings/willow stakes | 2.1 |

Source: Salix Applied Earthcare - Erosion Draw 5.0

- Live stake harvest and installation should be performed during the dormant season, late fall to early spring.
- Use site reconnaissance to identify willow species, growth form, soil and site conditions on adjacent sites and compare their conditions to the construction site. Planting will be more successful as soil, site and species selected match stable, vegetated nearby sites.
- If native willows are not found in the vicinity, live staking might not be a good option.
- Choose plant material adapted to the site conditions and confirm the availability of plant material that will be used on site before construction begins.

Construction Specifications

Harvesting

- Stakes must be harvested and planted when the willows (or other chosen species) are dormant. This period is generally from late fall to early spring or before the buds start to break.
- When harvesting cuttings, select healthy, live wood that is reasonably straight. Harvest live wood at least one-year-old or older. Avoid suckers of the current year's growth because they lack sufficient stored energy reserves to sprout consistently. The best wood is 2–5 years old with smooth bark that is not deeply furrowed.
- Stakes should be cut so that a terminal bud scar is within 1–4 inches of the top. At least two buds or bud scars must be above the ground after planting.
- Cuttings should generally be three-quarters of an inch in diameter or larger depending on the species, and 2 to 3 feet in length. Highest survival rates are obtained from using cuttings 2–3 inches in diameter. Larger diameter cuttings are needed for planting into rock riprap. Cuttings of small diameter stock (up to 1.5 inches) must be 18 inches long minimum. Thicker cuttings should be longer.
- Make clean cuts with unsplit ends. Trim branches from cutting as close as possible. The butt end (i.e., end closest to the ground) of the cutting must be pointed or angled and the top end (away from the soil) must be cut square, to aid in soil penetration, tamping, and knowing which end is up.
- The top, square cut can be painted and sealed by dipping the top 1–2 inches into a 50-50 mix of light colored latex paint and water. Sealing the top of the stake will reduce the possibility of desiccation and disease, assure the stakes are planted with the top up, and make the stakes more visible for subsequent planting evaluations.

Installation

- Install live stakes only on streambanks that have been graded and prepared for planting. ECB installation is strongly recommended for bank areas below the 2-year peak flow line; ECBs are recommended for upper portions of the bank. Stone toe protection is recommended for the toe of the slope at the waterline.
- Stakes must not be allowed to dry out. The cuttings should be installed the same day they are harvested. If this is not possible, they should be soaked in water for a minimum of 24 hours. Stakes can be stored outdoors for a few days in a cool place under damp straw. For longer storage, refrigerate (do not freeze), keep moist, and use as soon as possible.
- Use an iron stake, bar, or other suitable instrument to make a pilot hole in firm soil. Plant stakes 1–3 feet apart, closer on steeper slopes and on the outside of bends, farther apart on flatter slopes and the inside of bends. No less than one-half of total length must be into the ground. Set the stake as deep as possible into the soil, preferably with 80 percent of its length into the soil and in contact with midsummer water table.
- It is essential to have good contact between the stake and soil for roots to sprout. Tamp the soil around the cutting. Do not damage the buds, strip the bark, or split the stake during installation. Split or damaged stakes must be removed and replaced.
- Stakes must be planted with butt-ends into the ground. Leaf bud scars or emerging buds should always point up.

Inspection and Maintenance

- All temporary and permanent erosion and sediment control practices must be maintained and repaired as needed to assure continued performance of their intended function.
- Replace stakes that do not sprout after 45 days if possible, or wait until the following dormant season to harvest and replant.
- Streambanks and steep slopes are highly susceptible to erosion and damage from significant storm events. Willow stakes alone provide very little initial site protection during the establishment period. Use TRMs for temporary protection until stakes are established and to protect any bare areas.
- Periodic inspection repair and maintenance will be required during the first 2 years or until the vegetation is established.



This is a sprouting willow stake. To avoid upside-down installation of stakes, require that the lower ends be cut at an angle, with the upper end cut flat, i.e., perpendicular to stake length.



Willow stakes and other woody vegetation planted along the water's edge provide structural protection for colonization by other species, which promotes stable banks and improves habitat.



Soil wrap stabilization of steep stream bank using geotextile wrapping in 2 ft lifts. Live stakes can be driven into prepared banks using a dibble bar or iron stake to create a guide hole.

TYPICAL USE OF WILLOW STAKES TO ANCHOR WILLOW WATTLES, STRAW ROLLS, BIO MATS, OR TURF REINFORCEMENT MATS

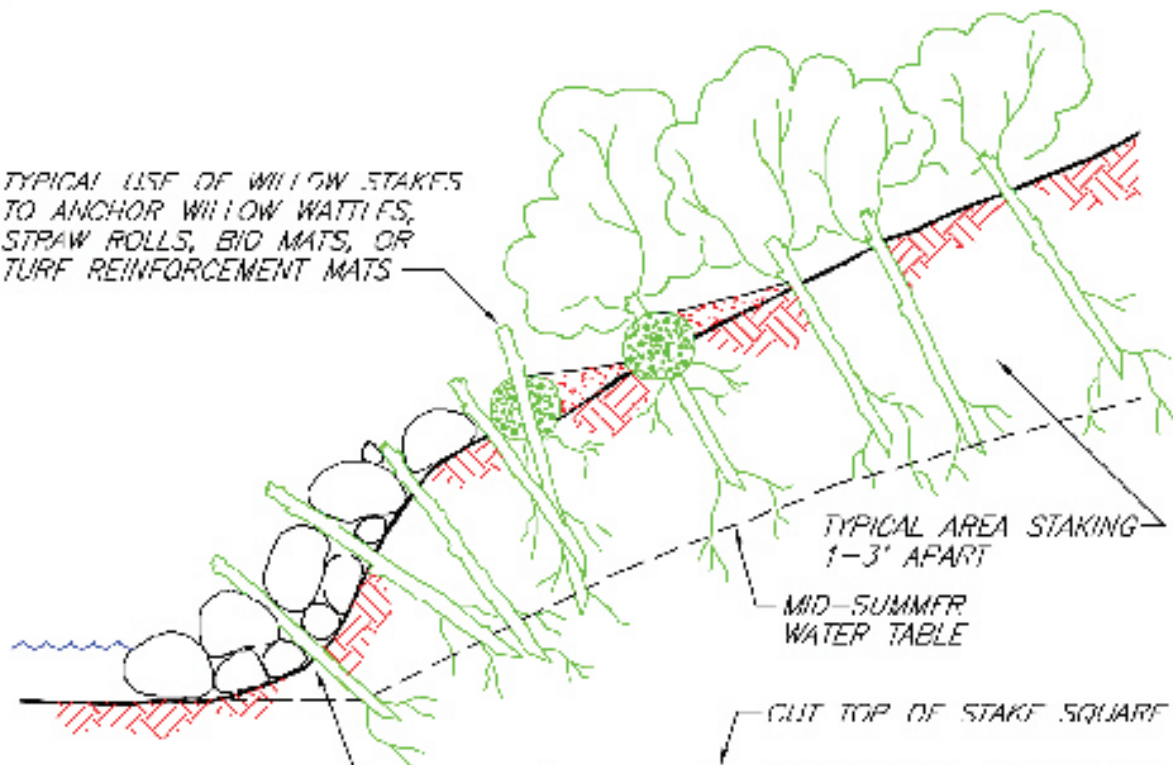

TYPICAL - DRIVE OR PLANT WILLOW STAKES THROUGH OPENINGS IN RIPRAP OR GABIONS

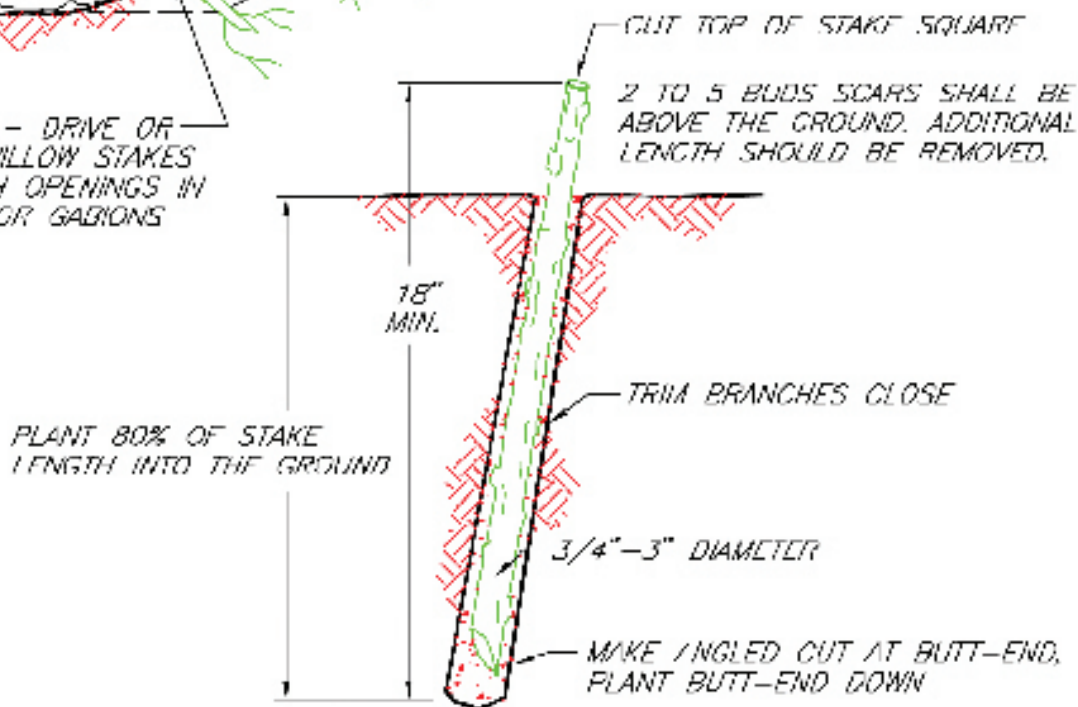

PLANT 80% OF STAKE LENGTH INTO THE GROUND

NOT TO SCALE

NOTES:

1. HARVEST AND PLANT STAKES DURING THE DORMANT SEASON.
2. USE HEALTHY, STRAIGHT AND LIVE WOOD AT LEAST 1 YEAR OLD.
3. MAKE CLEAN CUTS AND DO NOT DAMAGE STAKES OR SPLIT ENDS DURING INSTALLATION, USE A PILOT BAR IN FIRM SOILS.
4. SOAK CUTTINGS FOR 24 HOURS (MIN.) PRIOR TO INSTALLATION.
5. TAMP THE SOIL AROUND THE STAKE.

SOURCE: SALIX APPLIED EARTHCARE - EROSION DRAW 5.0

LIVE STAKING

4.8.5 Wattles (Live Fascines)



Installation of live fascines along bank area, before backfilling. Fascines provide quick, thick growth to stabilize banks and can be specified where willow or other suitable plant material is plentiful and erosive forces are moderate. Use turf reinforcement mats in areas where bank shear stress exceeds 2 pounds per square foot.

Definition

Wattles or live fascines are long, small-diameter, live branch cuttings, usually willows, bound together into long, cigar-shaped bundles and buried in shallow trenches to help stabilize slopes and streambanks.

Purpose

Thickly vegetated wattle and fascine bundles reduce erosion and stabilize streambank slopes in several ways:

- The wattle bundles, binding rope, and stakes are all structural components that combine to physically stabilize the surface layers of the slopes by resisting hydraulic and gravitational forces.
- Wattle bundles prevent rills and gullies by reducing the effective slope length, which dissipates the energy of water moving downslope. Wattles immediately reduce surface erosion.
- The terraces formed by a series of wattles trap sediment, detritus, and seed. Infiltration is increased as runoff is slowed, and on dry sites, this increases the available water for plant establishment.
- Vegetation establishment is enhanced because wattling provides a suitable microsite for plants by reducing surface erosion, increasing infiltration rates and by forming a series of terraces with shallower slope angles.

Wattling can be used for road fills, road cuts, gullies or slumped areas, eroded slopes or eroding streambanks as follows:

- Repair of small earth slips and slumps or to protect slopes from shallow slides 1–2 feet deep.
- Wattling can be used to stabilize entire cut or fill slopes, step-grades or small benches, or localized gully areas of slopes along water bodies.
- Wattling can be installed during construction (dormant season) or as a remedial action on existing slopes.
- Wattling is useful on slopes requiring other planting materials such as woody vegetation, transplants, grasses, and forbs. Wattling also enhances conditions for natural invasion and the establishment of other plants from the surrounding plant community.

Design Criteria

Wattles can be specified for streambanks with slopes of 3H:1V or flatter. Steeper slopes will require grooving, step-grading, or benching and ECBs that can withstand expected shear stresses. The following chart shows recorded shear stress withstood by willow wattles and fascines.

Bank Materials and Shear Stress Limits (Wattles)

| Bank Material | Shear (lb/ft ²) |
|---|-----------------------------|
| Wattles (coarse sand between) | 0.2 |
| Wattles (gravel between) | 0.31 |
| Wattles (parallel or oblique to current) | 1 |
| Fascine revetment | 1.4 |
| Live fascine (immediately after construction) | 1.22 |
| Live fascine (after 3–4 seasons) | 1.63 |
| Fascine | 2.1 |

Source: Salix Applied Earthcare - Erosion Draw 5.0

Choose plant material adapted to the site conditions and confirm the availability of plant material that will be used on-site before construction begins.

- The ideal plant materials for wattling are those that (1) root easily; (2) are long, straight and flexible; and (3) are in plentiful supply near the job site. Willow makes ideal wattling material.
- Wattle material harvesting and installation should be performed during the dormant season—late fall to early spring. Use site reconnaissance to identify appropriate willow or other species, growth form, soil and site conditions on adjacent sites, and compare their conditions to the construction site. Planting will be more successful as soil, site and species selected match stable, vegetated nearby sites.
- When choosing live willow material for bioengineering applications, remember that young (less than one year old) wood or suckers will often sprout easier under optimum conditions but healthy, older wood (1 to 4 years old) has greater vegetative (energy) reserves necessary to consistently sprout, and the older wood is much stronger. If possible, mix younger wood with older wood for the bioengineering application so that a majority of the material is 1 to 4 years old.
- Willows have several different growth forms, from shrubs to large trees. Small- to medium-sized shrub-type and rhizomatous or creeping-type willows are used for planting channel banks. Upland willow species are found in relatively dry areas and should be used on similar sites. Tree-type willows are selected for the upper bank and floodplain area.
- Spacing of contour trenches (wattles) is determined by soil type, potential for erosion, and slope steepness. Addition of rock toe slope protection where water surface meets the streambank is often helpful in reducing scour and bank slump. Installation of mulch or ECBs on slopes flatter than 4:1 and TRMs on steeper slopes is highly recommended.

General Installation Guidelines for Wattles

| Slope | Slope distance between wattles feet | Recommended maximum slope length feet |
|--------------|-------------------------------------|---------------------------------------|
| 1:1 to 1.5:1 | 3–4 | 15 |
| 1.5:1 to 2:1 | 4–5 | 20 |
| 2:1 to 2.5:1 | 5–6 | 30 |
| 2.5:1 to 4:1 | 6–8 | 40 |
| 3.5:1 to 4:1 | 8–12 | 50 |
| 4.5:1 to 5:1 | 10–20 | 60 |

Source: Salix Applied Earthcare - Erosion Draw 5.0

Construction Specifications

Wattle Preparation

- Cuttings must be harvested and planted when the willows, or other chosen species, are dormant. This period is generally from late fall to early spring.
- Choose plant materials that are adapted to the site conditions from species that root easily. A portion (up to 50 percent) of the bundle can be of material that does not root easily or dead material.
- The cuttings should be long (3 feet minimum), straight branches up to 1.5 inches in diameter. Trimmings of young suckers and some leafy branches can be included in the bundles to aid filtration. The number of stems varies with the size and kind of plant material.
- Cuttings must be tied together to form bundles, tapered at each end, 6–30 feet in length, depending on site conditions or limitations in handling.
- The completed bundles should be 6–12 inches in diameter, with the growing tips and butt ends oriented in alternating directions.
- Stagger the cuttings in the bundles so that the tips are evenly distributed throughout the length of the wattle bundle.
- Wattle bundles must be compressed and tightly tied with rope or twine of sufficient strength and durability. Polypropylene *tree rope* approximately 3/16 inch diameter provides the necessary strength and durability.
- Wattle bundles must be tied 12–15 inches apart.
- For optimum success, wattles should be pre-soaked for 24 hours or installed on the same day they are harvested and prepared. The wattles should be installed within 2 days after harvest unless pre-soaked. Wattles must be stored in the shade and under cover or under water. They are live material and should be treated as such.

Installation

- Work must progress from the bottom to the top of the slope. See the design section for spacing and use of blankets/mats on slopes.
- Perform any slope repairs, such as gully repair, slope scaling, diversion dike, gabion, or toe wall construction, before installing the wattle.

- Beginning at the base of the slope, dig a trench on contour. The trench must be shallow, about one-half the diameter of the wattle. The trench width will vary from 12–18 inches depending on the slope angle.
- Install wattles into trenches dug into the slope on contour. Place the wattles immediately after trenching to reduce desiccation of the soil.
- Wattles must be staked firmly in place with one row of construction stakes on the downhill side of the wattling, not more than 3 feet apart. A second row of stakes must be placed through the wattles, near the ties, at not more than 5 feet apart.
- Overlap the tapered ends of adjacent wattles so the overall wattle thickness of the wattle is uniform. Two stakes must be used at each bundle overlap such that a stake can be driven between the last two ties of each wattle.
- Live stakes, if specified, are generally installed on the downslope side of the bundle. Drive the live stakes below and against the bundle between the previously installed construction stakes.
- Proper backfilling is essential to the successful rooting of the wattles. Backfill wattles with soil from the slope or trench above. The backfill must be worked into the wattle interstices and compacted behind and below the bundle by walking on and working from its wattling terrace.
- Place moist soil along the sides of the live bundle. The top of the bundle should be slightly visible when the installation is completed.
- Repeat the preceding steps for each row, up to the top of the slope.
- Plant the slope with other vegetation (e.g., live stakes, tree seedlings) as specified.
- Seed and mulch slope. Shallow slopes, generally 3:1 or flatter can be seeded and mulched by hand. Steeper slopes should have seed applied hydraulically, and the mulch must be anchored with tackifier or other approved methods if TRMs are not used.

Inspection and Maintenance

- Inspect and maintain the wattle installations regularly, particularly during the first year.
- Repairs must be made promptly. Stakes that loosen because of saturation of the slope or frost action must be reinstalled.
- Rills and gullies around or under wattles must be repaired. Use ECBs or TRMs if necessary to control scouring and gullying.
- Repairs to vegetative practices must be made promptly.
- All temporary and permanent erosion and sediment control practices must be maintained and repaired as needed to assure continued performance of their intended function.

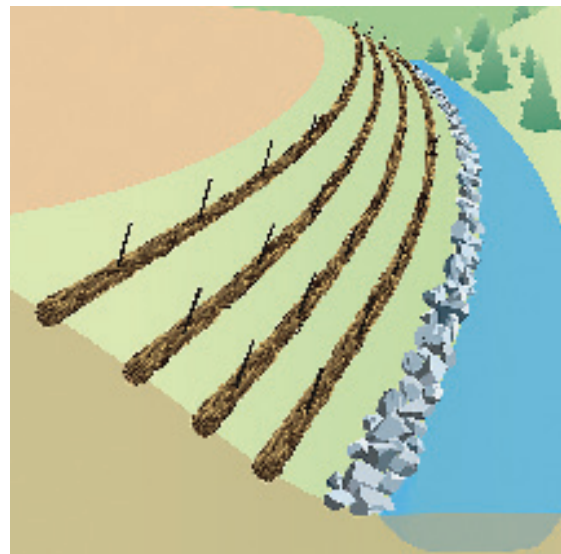

Coconut logs, fiber rolls, and other products can be used in conjunction with wattles to ensure adequate protection while plant material is becoming rooted. Follow manufacturer's installation information.

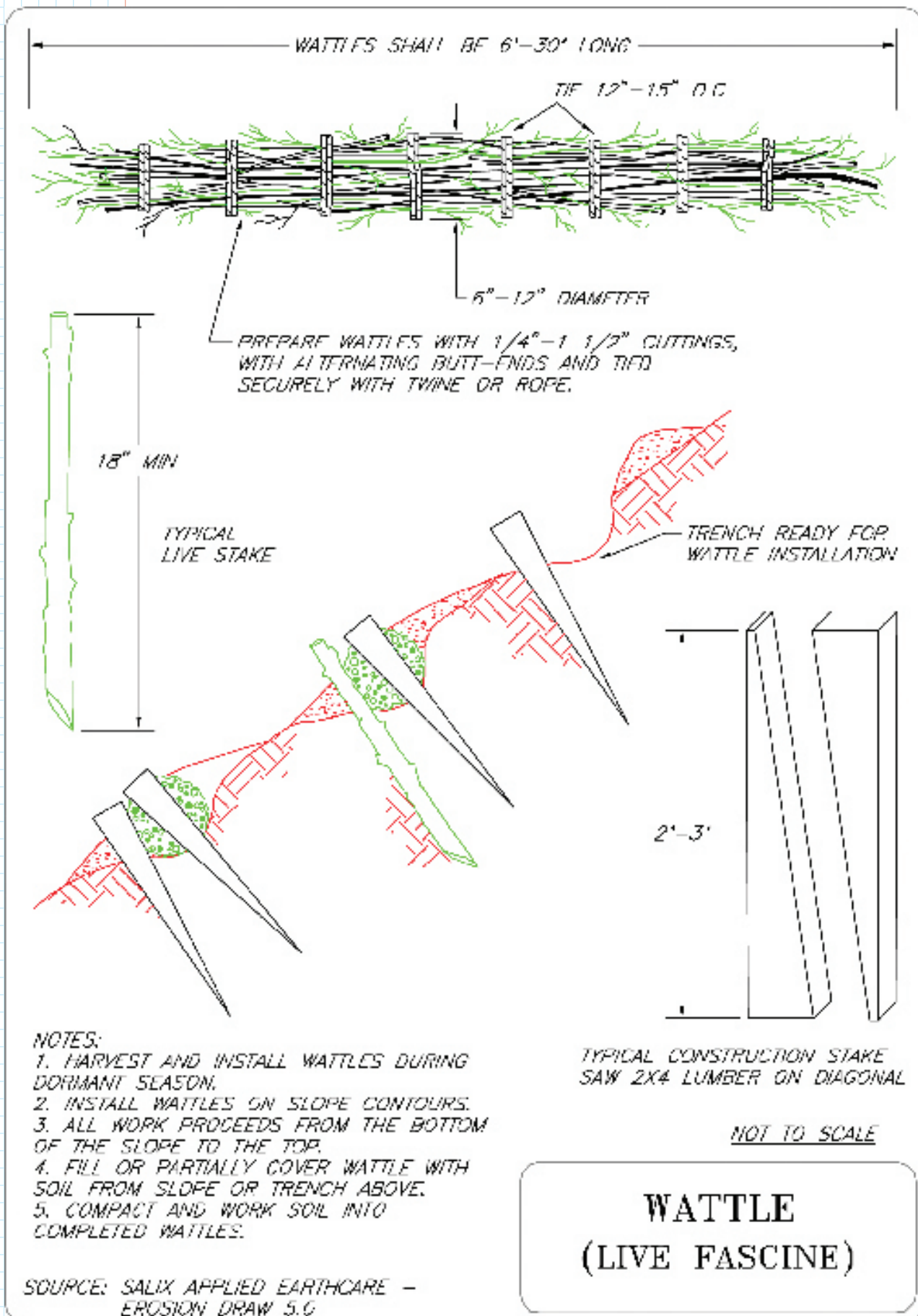

4.8.6 Brushlayering



Brushlayering is similar to installation practices for live fascines. As in other vegetative practices using woody material, willows are preferred because of their low price, wide availability, and hardiness. Supplement brush layers with TRMs if bank shear stress exceeds 2 lbs per sq ft.

Definition

Brushlayering is the installation of cuttings or branches of easily rooted tree species, which are layered between successive lifts of soil fill to construct a reinforced slope or embankment.

Purpose

This technique is used to stabilize slopes, particularly road fill slopes where construction has or will result in unstable soil conditions. The brushlayer branches, especially after rooting, reinforce slopes by serving as tensile inclusions that provide frictional resistance to sliding or other types of displacement. The protruding brush retards runoff and reduces surface erosion.

Brushlayering is best used concurrently with construction of fill slopes or embankments. Cuttings are placed by hand, while heavy equipment is used to fill and compact each successive lift of soil fill. Brushlayering is similar in principle to other reinforced earth practices except that the reinforcing material is live branches. This practice is also a good remedial action intended to repair gullies or existing slopes. Brushlayering performs several functions for erosion control, earth reinforcement, and slope stability:

- Breaking up the slope length into a series of shorter slopes separated by rows of brush layer
- Reinforcing the soil with the unrooted branch stems
- Reinforcing the soil as roots develop, adding significant resistance to sliding or shear displacement
- Providing slope stability and allowing vegetative cover to become established
- Trapping debris on the slope
- Aiding infiltration on dry sites and drying excessively wet sites
- Adjusting the site's microclimate, thus aiding seed germination and natural regeneration
- Redirecting and mitigating adverse slope seepage by acting as horizontal drains

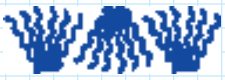

Design Criteria

Brushlayering is specified where significant streambank grading work or new streambank construction occurs. Live branch cuttings are oriented perpendicularly to the slope contour (i.e., up and down the hill), placed in a series of stair-step trenches on the slope, and covered with soil. The following chart shows recorded shear stress withstood by brushlayering.

Brush Materials and Shear Stress Limits (Brush Layers)

| Brush Material | Shear (lb/ft ²) |
|--|--------------------------------|
| Willow brushlayer (immediately after construction) | 0.41 |
| Willow brushlayer (after 3–4 seasons) | 2.86 |
| Willow cuttings/willow stakes | 2.1 |

Source: Salix Applied Earthcare - Erosion Draw 5.0

- Plant material harvest and installation should be performed during the dormant season, late fall to early spring.
- Use site reconnaissance to identify willow or other species, growth form, soil and site conditions on adjacent sites and compare their conditions to the construction site. Planting will be more successful as the soil, site conditions and species selected match stable and vegetated nearby sites.
- The ideal plant materials are those that (1) root easily; (2) are long, straight and flexible; and (3) are in plentiful supply near the job site. Willow makes ideal material.
- Choose plant material adapted to the site conditions and confirm the availability of plant material that will be used on site before construction begins.
- When choosing live willow material for bioengineering applications, remember that young (less than one year old) wood or suckers will often sprout easier under optimum conditions but healthy, older wood (1 to 4 years old) has greater vegetative (energy) reserves necessary to consistently sprout, and the older wood is much stronger. If possible, mix younger wood with older wood for the bioengineering application so that a majority of the material is 1 to 4 years old.
- Willows have several different growth forms—from shrubs to large trees. Small- to medium-sized shrub-type and rhizomatous or creeping-type willows are used for planting channel banks. Upland willow species are found in relatively dry areas and should be used on similar sites. Tree-type willows are selected for the upper bank and floodplain area.
- If branch cuttings are not pre-soaked for at least 24 hours, then they must be harvested no earlier than 48 hours before installation. Cuttings must be kept moist and cool at all times between cutting and installation. All cuttings need to be thoroughly wet and covered with moistened wrapping before being transported.
- Construction personnel must be made aware that brushlayering uses live plant material and must be treated as such.
- Spacing between the brushlayers is determined by the erosion potential of the slope (i.e., soil type, rainfall, and length and steepness of the slope). Spacing can be from 3 to 8 feet. On long slopes, brushlayer spacing should be closer at the bottom and spacing can increase near the top of the slope.

- Slopes flatter than 4H:1V can be layered, seeded, and protected with mulch or ECBs. Steeper slopes will require turf reinforcement mats below the 2-year peak flow line. Steep slopes (1H:1V) should not exceed approximately 30 feet in slope length. Reinforced earth design guidelines suggest that the slope height should not exceed three times the width of the reinforced volume. Therefore, for brushlayering with 6–8 foot long cuttings, the slope height should not exceed 18–24 feet.
- Stabilization of slopes on the outside bends of streams will likely require vegetative, structural, or other armoring in addition to brushlayering, to handle the higher-flow velocities and sheer stresses encountered.

Construction Specifications

Cuttings must be harvested and planted when the willows, or other chosen species, are dormant. This period is generally from late fall to early spring. Choose plant materials that are adapted to the site conditions from species that root easily.

- Branch cuttings must be 4–8 feet long, 3/4–2 inches diameter. Presoak cuttings for a minimum of 24 hours before installing.
- Complete grading and other work on streambank slopes. Install rock or other toe protection if specified in construction plans. Prepare first (lowest elevation) bench, removing soil or using it to backfill toe protection zone. The surface of the bench must be sloped so the outside (near stream) edge is higher than the inside (bank) edge, so that the butt ends of the cuttings angle down slightly into the slope.
- Place branch cuttings, 3–8 inches thick, in a crisscross or over lapping configuration. The growing tips must protrude 6–12 inches from the slope face with the butt end dipping into the slope.
- Immediately cover brushlayer with 6 inches of fill soil and compact according to construction specifications. For ease of installation, use soil excavated from the bench immediately upslope to cover cuttings placed in the lower bench excavations. Water the soil cover immediately to wet the cuttings and achieve adequate compaction.
- Earth moving equipment must not travel directly over the cuttings. Six inches of soil must be maintained between the brushlayer and equipment at all times.
- Fill and compact the soil placed above the brushlayer in successive lifts, maximum 6–8 inches deep. Install the next brushlayer 3-8 feet above the previous row.
- Seed and mulch the slope, or install erosion control blanket or turf reinforcement mat as needed. Shallow slopes, generally 3:1 or flatter might be seeded and mulched by hand. Steeper slopes should have seed applied hydraulically, and the mulch must be anchored with tackifier or other approved methods of TRMs are not used.

Inspection and Maintenance

Regularly inspect and maintain bioengineering installations, particularly during the first year. To prevent major problems from developing, promptly correct any failures.

NOTE:
 ROOTED, LEAFED CONDITION OF THE
 LIVING PLANT MATERIAL IS NOT
 REPRESENTATIVE OF THE TIME OF
 INSTALLATION

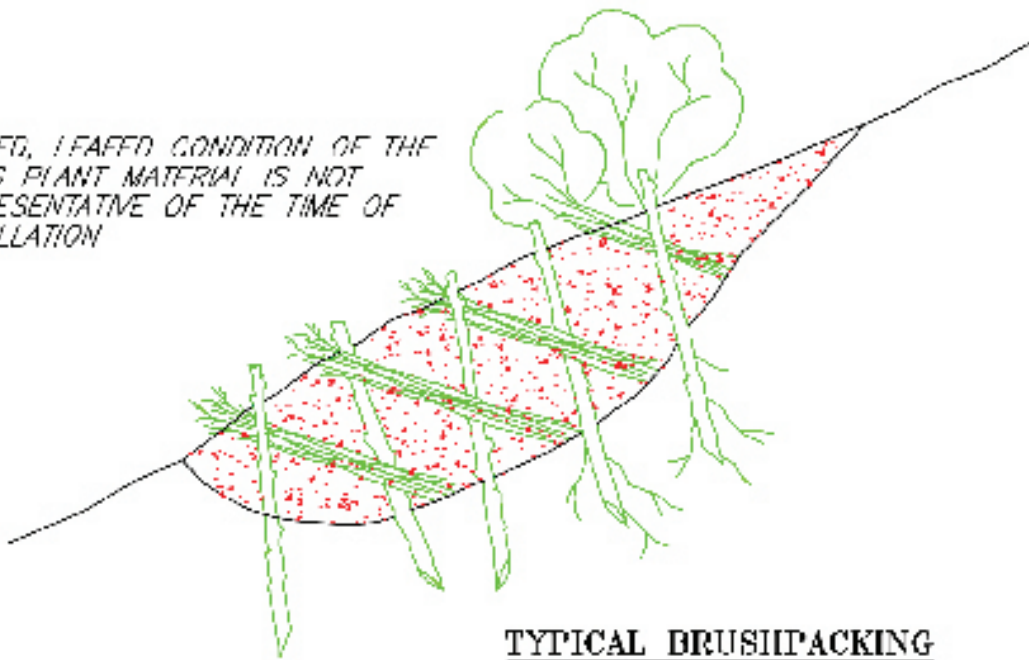

TYPICAL BRUSHPACKING

COVER BRUSHLAYER IMMEDIATELY WITH
 6" OF FILL SOIL, WATER AND COMPACT
 ACCORDING TO SPECIFICATIONS

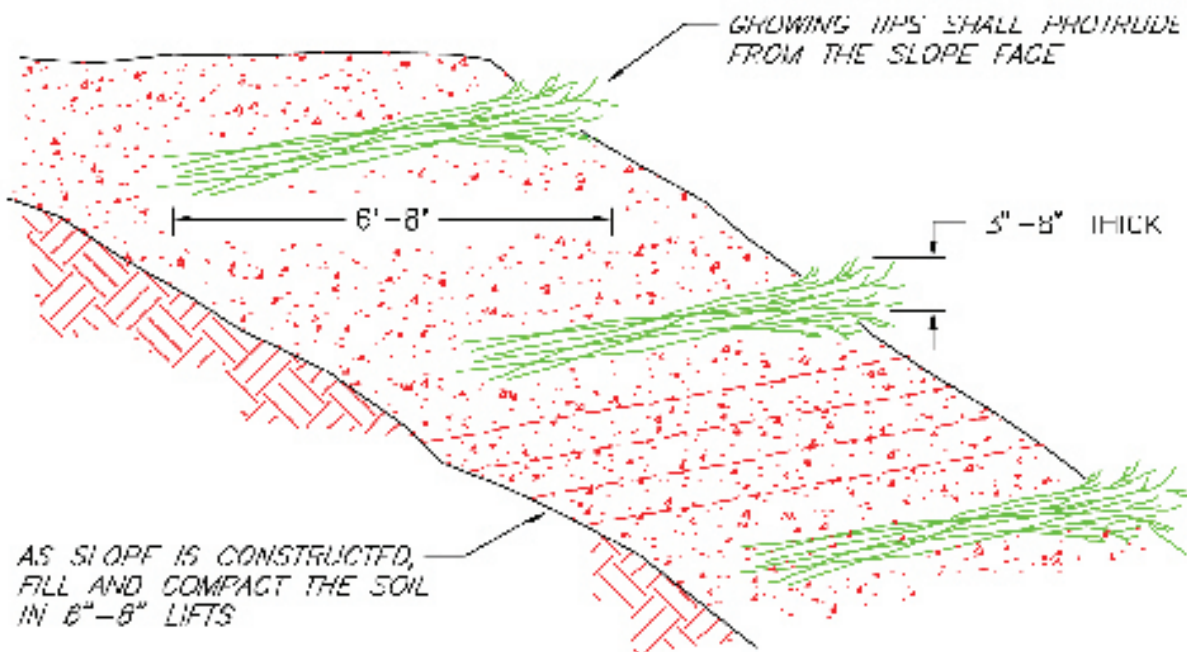

**TYPICAL BRUSHLAYERING
 WITH SLOPE CONSTRUCTION**

BRUSHLAYERING

SOURCE: SALIX APPLIED EARTH CARE -
 EROSION DRAW 5.0

4.9 Good Housekeeping and Other Runoff Controls

Good housekeeping practices are not typically entered on site maps or drawings but are described in the Stormwater Pollution Prevention Plan and standard notes. These practices are included as part of the construction operations and management process. Good housekeeping practices include plans, procedures, and activities designed to prevent or minimize the use or exposure of materials that could become pollutants.

Good housekeeping practices seek to reduce or eliminate pollutants being added to construction site runoff through analysis of pollutant sources, implementing proper handling and disposal practices, employee education, and other actions.

In general, good housekeeping focuses on keeping the work site clean and orderly, storing materials under roof or tarps whenever possible, and handling materials and wastes in manner that minimizes risk and potential pollutant runoff. A variety of good housekeeping practices have been developed to reduce or eliminate runoff pollutants. These practices—along with relevant application information—are summarized in the following sections.



Good housekeeping includes management of solid and sanitary wastes, hazardous materials, and other construction site materials that could contaminate runoff. Staff should be familiar with basic procedures for storing and managing site materials and how to respond in the event of a spill or other event that might threaten water resources.



These show poor housekeeping practices. Sloppy material storage and waste disposal practices are often indicative of inadequate stormwater management throughout the construction site. Inspectors often target sites like these for more detailed inspections.



4.9 Good Housekeeping and Other Runoff Controls

4.9.1 Material Delivery, Storage, and Use



A wide variety of construction site materials—such as soil amendments, fertilizers, paint, and fuels—can contaminate stormwater runoff if not stored properly. In general, storing materials under roof or covering with a secure tarp provides good protection against polluting construction site runoff. Job site supervisors should check for leaching or spreading of contaminants from fuel storage areas, landscaping stockpiles, and other places where potentially hazardous materials are stored.



Definition

This is the practice of receiving, processing, storing, and using materials in a manner that minimizes the risk of spills and pollution of stormwater runoff.

Purpose

The purpose of material delivery, storage, and use is to prevent the material from being spilled or otherwise coming into contact with runoff.

Implementation

- Designate specific areas of the construction site for material delivery and storage
- Place material storage areas near the construction entrance and away from waterways and storm drain inlets
- Where possible, place materials designated for outside storage in locations that will be paved
- Install containment berms or rock check dams between stored materials (e.g., topsoil, fertilizer) and the site drainage system
- Minimize on-site storage of materials and schedule delivery of material for when it will be needed
- Minimize hazardous materials stored on-site
- Store hazardous or toxic materials in a covered area or indoors if possible
- Provide secondary storage for materials
- Keep materials in original containers and labeled
- Keep containers tightly sealed after use
- Train employees and subcontractors



Keep hazardous materials under cover and over collection pans to prevent problems.

Inspection and Maintenance

- Inspect material storage area weekly and after each rainfall greater than one-half inch
- Inspect material storage areas for cleanliness, spills, and leaks
- Clean up spills promptly; keep spill kits nearby

4.9 Good Housekeeping and Other Runoff Controls

4.9.2 Spill Prevention and Control



Spill prevention and control measures require planning and monitoring to ensure that problems are minimized. Locate storage and handling areas for hazardous liquids away from waterways and culvert inlets. Clean up spills immediately, and report large spills to the KYDOW and Division of Waste Management.



Definition

Spill prevention and control are procedures that establish spill response and control actions by anticipating when and how spills might occur and instituting defined actions to contain and clean it up.

Purpose

Leaks and spills can significantly pollute runoff from a construction site. Prepare for potential spills by reducing the chance for spills to occur, stopping the source of spills, containing and cleaning up spills, properly disposing of spill material, and training employees. Planning and prevention can minimize spills at a construction site. Trained employees with the proper spill response equipment can also prevent spills from polluting runoff.

Implementation

- Store materials away from waterways and storm drain inlets.
- Store hazardous or toxic materials indoors if possible, or in other areas safe from vehicular traffic, vandals, and equipment movement.
- Place a stockpile of spill cleanup materials where it can be easily accessed.
- Train employees and subcontractors on the need to prevent spills.
- Train employees on spill prevention and response.
- Fix leaks and clean up spills immediately.
- Use dry methods to clean up spills—never hose down or bury spill materials.
- Dispose of absorbent material properly. For small quantities, place in double plastic bagging and discard with solid waste. For larger quantities, refer to material safety data sheets and KY Division of Waste Management (502.564.6716 or www.waste.ky.gov) disposal requirements.
- For major spills or spills that enter a waterway or storm drain inlet, report the spill to the Kentucky Division of Water (502.564.2380). See list below for regional office phone numbers.

Emergency Numbers for Spills that Enter Waterways or Storm Drains

| Location | Phone Number |
|---------------|----------------|
| Statewide | (800) 928-2380 |
| Bowling Green | (270) 746-7475 |
| Columbia | (270) 384-4734 |
| Florence | (859) 525-4923 |
| Frankfort | (502) 564-3358 |
| Hazard | (606) 435-6022 |
| London | (606) 330-2080 |
| Louisville | (502) 429-7120 |
| Madisonville | (270) 824-7529 |
| Morehead | (606) 784-6634 |
| Paducah | (270) 898-8468 |

Construction sites and other facilities that have aboveground storage capacity in excess of 1,320 gallons for petroleum products are required to comply with federal regulations posted at 40 CFR Part 112, which mandates the preparation and implementation of a Spill Prevention, Control, and Countermeasure (SPCC) Plan. The purpose of the SPCC Plan is to establish procedures, methods, and equipment to prevent or mitigate the discharge of oil from nontransportation-related onshore and offshore facilities into or upon the navigable waters of the United States. SPCC Plans must be prepared in accordance with sound engineering practices. The Kentucky Transportation Cabinet has a template for developing a SPCC Plan, posted at www.kytc.state.ky.us/EnvAnalysis/Stormwaterquality/PDF/Appendix_1-6.pdf.



Keep spill absorbents, containment dams, and other spill response materials close to the location of possible spills. Make sure employees know how to contain and report spills.

4.9.3 Vehicle and Equipment Maintenance



Service vehicles and equipment in locations where spills can be contained and cleaned up easily. Use sand, absorbents, and containment berming when changing oil or servicing hydraulic cylinders and lines. Clean up spills quickly and dispose of residue properly.



Definition

Vehicle and equipment maintenance are policies and procedures that specify how and where vehicles and equipment will be cleaned, fueled, and maintained in a manner that minimizes risks for spills and runoff of pollutants.

Purpose

Vehicle and equipment cleaning, fueling, and maintenance should ideally be conducted at an off-site facility. When cleaning, fueling, or maintenance must be conducted at the construction site, properly trained employees should do it in designated areas. Practices to properly clean, fuel, and maintain vehicles and equipment will help prevent and minimize spills from these activities. This practice will also minimize the exposure of oil and grease, hydrocarbons, and other pollutants in runoff from the construction site.

Implementation

- Use off-site repair and fueling shops as much as possible.
- If storing fuel on-site, specify double-containment systems and site fuel tanks on upland areas well away from stormwater drainage ditches, inlets, and streams.
- Use off-site facilities to wash vehicles and equipment as much as possible.
- If maintenance or fueling must occur on-site, designate an area away from waterways and storm drain inlets.
- Do not store batteries, oil, or other materials where they could be exposed to runoff.
- Use drip pans or absorbents under leaking vehicles or equipment.
- Properly dispose of used oil, lubricants, and grease.
- When washing vehicles or equipment, locate washing away from waterways or storm drain inlets, use phosphate-free, biodegradable soaps, and minimize the amount of water used.
- When fueling on-site, minimize mobile fueling; instead, designate a fueling location and bring vehicles and equipment to the designated fueling location.
- Protect on-site cleaning, fueling, and maintenance areas with berms or dikes.
- Train employees and subcontractors.
- Inspect vehicles and equipment daily for leaks. Check fueling area for any leaks or spills, and ensure that spill cleanup kits are available and fully stocked.

4.9.4 Debris and Trash Management



Use open containers for solid wastes with no potential for leaching contaminants, such as wood waste, packaging, and other inert material. For wastes with high leaching potential (e.g., paint containers, powders, granular material), use only covered containers and keep the lid closed.



Definition

Debris and trash management practices are policies and procedures designed to minimize the generation of waste and to handle and dispose of waste in a manner that minimizes risks to surface waters.

Purpose

Large volumes of debris and trash are often generated at construction sites including packaging, pallets, wood waste, concrete waste, soil, electrical wiring, cuttings, and a variety of other materials. There are several techniques and procedures to minimize the potential of stormwater contamination from solid waste through appropriate storage and disposal practices. Recycling construction debris also reduces the volume of material to be disposed of and the associated costs. Debris and trash management should be a part of all construction practices. By limiting the trash and debris on-site, stormwater quality is improved along with reduced cleanup requirements at the completion of the project.

Implementation

Solid waste management for construction sites is based on proper storage and disposal practices by construction workers and supervisors. Key elements of the program are education and modification of improper disposal habits. Supervisors and workers must cooperate and be vigilant to ensure that the recommendations and procedures are followed. Following are lists describing the targeted materials and recommended procedures.

Construction (and Demolition) Debris

- Dimensional lumber
- Miscellaneous wood (e.g., pallets, plywood)
- Copper (pipe and electrical wiring)
- Miscellaneous metal (e.g., studs, pipe, conduit, sheathing, nails)
- Insulation
- Concrete, brick, and mortar
- Shingles
- Roofing materials
- Gypsum board

Trash

- Paper and cardboard (packaging, containers, wrappers)
- Plastic (packaging, bottles, containers)
- Styrofoam (cups, packing, and forms)
- Food and beverage containers
- Food waste

Storage Procedures

- Stress to employees the importance of keeping the work site clean.
- Wherever possible, minimize production of debris and trash.
- Designate a foreman or supervisor to oversee and enforce proper debris and trash procedures.
- Instruct construction workers in proper debris and trash storage and handling procedures.
- Segregate potentially hazardous waste from nonhazardous construction site debris.
- Segregate recyclable construction debris from other nonrecyclable materials.
- Keep debris and trash under cover either in a closed dumpster or other enclosed trash container that limits contact with rain and runoff and prevents light materials from blowing out.
- Store waste materials away from drainage ditches, swales, and catch basins.
- Do not allow trash containers to overflow.
- Do not allow waste materials to accumulate on the ground.
- Prohibit littering by workers and visitors.
- Police the site daily for litter and debris.
- Enforce solid waste handling and storage procedures.

Disposal Procedures

- If feasible, recycle construction and demolition debris such as wood, metal, and concrete.
- General construction debris may be hauled to a licensed construction debris landfill (typically less expensive than a sanitary landfill).
- Use waste and recycling haulers or facilities approved by the local jurisdiction.

Education

- Educate all workers on solid waste storage and disposal procedures.
- Instruct workers in identification of solid waste and hazardous waste.
- Have regular meetings to discuss and reinforce disposal procedures (incorporate in regular safety seminars).
- Clearly mark on all debris and trash containers which materials are acceptable.

Quality Control

- The foreman or construction supervisor should monitor on-site solid waste storage and disposal procedures.
- Discipline workers who repeatedly violate procedures.

Performance Indicators

- No contaminated runoff from waste containers entering stormwater system.
- Jobsite waste handling and disposal education and awareness program.
- Compliance by workers with policies and procedures.
- Sufficient and appropriate waste storage containers.
- Timely removal of stored solid waste materials.
- Training workers and monitoring compliance.



Here is an example of poor waste management. Construction contractors should provide appropriate waste disposal containers, and employees should be instructed to use them.



Sites like this one are often the subject of public complaints to state and local planning and regulatory agencies. Good housekeeping practices keep complaints down, inspectors happy, and water clean.

Polluted runoff from construction sites can result in fines up to \$27,500 per day per violation. Stop work orders can cause construction delays of days, weeks, or even months.

4.9.5 Hazardous Waste Management



Hazardous materials—such as paint, fuel, oil, fertilizers, and such—should be managed to prevent spills or runoff into storm drains and waterways.



Definition

Hazardous waste management practices are policies and procedures that address the problem of stormwater polluted with hazardous or chemical pollutants through spills or other forms of contact.

Purpose

The objective of hazardous materials management is to minimize the potential of stormwater contamination from construction chemicals through appropriate recognition, handling, storage, and disposal practices. Chemical management is not intended to supersede or replace normal site assessment and remediation procedures. Significant spills or contamination warrant immediate response by trained professionals. Suspected job-site contamination should be immediately reported to regulatory authorities and protective actions taken. These management practices, along with applicable Occupational Safety and Health Administration (OSHA) and EPA guidelines, should be incorporated at all construction sites that use or generate hazardous wastes. Many chemicals such as fuel, oil, grease, fertilizer, and pesticide are present at most construction sites.

Implementation

The chemical management techniques presented here are based on proper recognition, handling, and disposal practices by construction workers and supervisors. Key elements are education and proper disposal practices, as well as provisions for safe storage and disposal. Following are lists describing the targeted materials and recommended procedures.

Targeted Chemical Materials

- Paints
- Solvents
- Stains
- Wood preservatives
- Cutting oils
- Greases
- Roofing tar
- Pesticides, herbicides, and fertilizer
- Fuels and lube oils
- Antifreeze

Storage Procedures

- Wherever possible, minimize the use of hazardous materials.
- Minimize generation of hazardous wastes on the jobsite.
- Segregate potentially hazardous waste from nonhazardous construction site debris.
- Designate a foreman or supervisor to oversee hazardous materials handling procedures.
- Keep chemicals in appropriate containers (closed drums or similar) and under cover.
- Store chemicals away from drainage ditches, swales, and catch basins.
- Use containment berms in fueling and maintenance areas and where the potential for spills is high.

Waste Handling

- Minimize water usage during paint wash-up. Dispose of paint wash water with other liquid wastes, spread on graveled sites prepared for new concrete pouring, or areas being prepared for paving. Do not dispose of wash water in ditches or stormwater inlets.
- Retain and use all products such as paint, thinners, and so on until supplies are depleted. Do not dispose of liquid wastes on pavement or near ditches or stormwater inlets.
- Allow paint rollers, drop cloths, cans, and other wastes to dry thoroughly, then discard in solid waste containers.
- Recycle or dispose of all liquid wastes in accordance with material safety data sheets.
- Ensure that adequate hazardous waste storage volume is available.
- Ensure that hazardous waste collection containers are conveniently located.
- Do not allow potentially hazardous waste materials to accumulate.
- Enforce hazardous waste handling and disposal procedures.
- Clearly mark on all hazardous waste containers which materials are acceptable for the container.

Disposal Procedures

- Ensure that adequate cleanup and containment materials are available on-site.
- Regularly schedule hazardous waste removal to minimize on-site storage.
- Use only licensed hazardous waste haulers.

Education

- Instruct workers on safety procedures for construction site chemical storage.
- Instruct workers in identification of chemical pollutants.
- Ensure that workers are trained in procedures for spill prevention and response.
- Educate workers of potential dangers to humans and the environment from chemical pollutants.
- Educate all workers on chemical storage and disposal procedures.
- Have regular meetings to discuss and reinforce identification, handling, and disposal procedures (incorporate in regular safety seminars).
- Establish a continuing education program to train new employees.

Quality Assurance

- The foreman or construction supervisor must monitor on-site chemical storage and disposal procedures.

- Educate and, if necessary, discipline workers who violate procedures.
- Ensure that the hazardous waste disposal contractor is reputable and licensed.

Performance Indicators

- Jobsite chemical and hazardous waste handling and disposal education and awareness program.
- Commitment by management to implement chemical storage and hazardous waste management practices.
- Compliance by workers.
- Sufficient and appropriate chemical and hazardous waste storage containers.
- Timely removal of stored hazardous waste materials.



Store hazardous liquids like fuel, oil, and paint under roof and over spill pans. Keep spill cleanup supplies handy, and train staff in how to prevent and respond to spills.

Hazardous waste management involves caution, care, and common sense. This temporary fuel tank is sited on an unpaved area away from the drainage system. Note that rainwater has accumulated in the secondary containment box—clean stormwater should be drained regularly to ensure adequate volume in the event of a leak or overflow. Fill tanks in high-risk areas two-thirds full to avoid overfilling and spills.



4.9.6 Concrete Waste Management



Concrete washout structures or areas should be designated and used to prevent discharge of highly alkaline wash water to the storm sewer or surface streams. Use bermed areas created with hay bales, earthen dikes, or other material—do not dispose of concrete wastes in excavated holes in areas with high groundwater tables. The best place to discharge excess concrete and concrete wash water is into formed-up areas that have been prepared for the next pour. Make sure no material flows out of the concrete forms.



Definition

Concrete waste management is a set of policies and procedures that address the handling and disposal of (1) excess fresh concrete mix, including truck and equipment washing, and (2) concrete dust and concrete debris resulting from demolition.

Purpose

Concrete waste and wash water from trucks are present at most construction sites. Both forms of concrete waste have the potential to impact water quality through stormwater runoff contact with the waste. The purpose of good housekeeping practices associated with managing these wastes is to prevent stormwater contamination and impacts to receiving waters downstream.

Implementation

A number of water quality parameters can be affected by introduction of concrete, especially fresh concrete. Concrete contains hexavalent chromium and affects the pH of runoff, causing significant chemical changes in water bodies and harming aquatic life. Suspended solids in the form of both cement and aggregate dust are also generated from both fresh and demolished concrete waste.

Unacceptable Concrete and Wash Water Disposal Practices

- Dumping in unmanaged vacant areas on the job site.
- Illicit dumping away from the job site.
- Dumping into ditches, storm drains, or drainage facilities.
- Dumping wash water from trucks and chutes into storm drains

Recommended Disposal Practices

- Prevent runoff of wash water and concrete waste into storm drains, ditches, and waterways.
- If possible, dump waste and wash water into areas prepared for new concrete pouring.
- If no future pour site is available, develop other safe concrete disposal areas.
- Provide a washout area with a minimum of 6 cubic feet of containment area volume for every 10 cubic yards of concrete poured.
- Never dump waste concrete illicitly or without the property owner's knowledge and consent.
- Wash water must be handled in a manner that does not result in a violation of groundwater or surface water quality standards.

Education

- Drivers and equipment operators should be instructed on proper disposal and equipment washing practices (see above).
- Supervisors must be made aware of the potential environmental consequences of improperly handled concrete waste.

Enforcement

- The construction site manager or foreman must ensure that employees and pre-mix companies follow proper procedures for concrete disposal and equipment washing.
- Employees violating disposal or equipment cleaning directives must be reeducated or disciplined if necessary.

Demolition Practices

- Monitor weather and wind direction to ensure that concrete dust is not entering drainage structures and surface waters.
- Where appropriate, construct sediment traps or other types of sediment detention devices downstream of demolition activities.

Performance Indicators

- Use predetermined disposal sites for waste concrete.
- Prohibit dumping waste concrete anywhere but predetermined areas.
- Assign predetermined truck and equipment washing areas.
- Educate drivers and operators on proper disposal and equipment cleaning procedures.



This is a commercial concrete washout tank with fold-up ramp.

Shown here is a straw bale and plastic concrete washout structure. Place concrete washouts in convenient locations, make sure mixing truck drivers know where they are, and make sure they use them.



4.9.7 Sanitary Facilities

Provide sanitary waste facilities for construction site workers in convenient locations and have them serviced regularly. Do not site them near storm drain inlets.



Definition

Sanitary facilities practices provide facilities for collection and disposal of sanitary waste and ensure that they are properly managed to minimize the potential contamination of surface water with septic wastes. Location of portable facilities away from storm drain systems and surface waters or containment is necessary in case of spills.

Purpose

The purpose of this good housekeeping BMP is to prevent the contamination of stormwater with human waste and to provide for proper public health protection and employee safety.

Implementation

- Sanitary facilities must be provided on the site in close proximity to areas where people are working.
- Portable toilets must be provided if no permanent facilities are available.
- Locate portable toilets a minimum of 20 feet away from storm drain inlets, conveyance channels, or surface waters.
- If unable to meet the 20-foot distance requirement, provide containment for portable toilets.
- Portable toilets should be regularly serviced.



Relocate sanitary facilities as needed when the active work area changes. Make sure facilities are well away from vehicle and equipment traffic.

4.9.8 Employee Training



All employees should receive regular training and frequent updates on good housekeeping plans and practices. Murphy's Law postulates that the employee with the most training will be the farthest away when a spill or accident happens, so make sure your least-trained employee is ready to act!



Definition

Employee training includes workshops, meetings, and other structured interaction among managers and employees to distribute and discuss information regarding the control of erosion and the runoff of sediment or other pollutants from the construction site.

Purpose

Employee training ensures that both employees and subcontractors are aware of and follow appropriate practices to prevent polluted runoff from leaving construction sites. Education should be provided on basic requirements, water quality impacts, BMPs, and inspection or maintenance procedures at construction sites.

Implementation

- Use this *Kentucky BMP Planning and Technical Specifications Manual* as the training workbook
- Train both employees and subcontractors
- Integrate erosion and sediment control training with spill response training, safety training, or other training where appropriate.
- Reinforce training with frequent refreshers
- Consider posting information on BMPs for employees to read
- Consider sending employees to erosion and sediment control training courses



Training in the classroom and in the field are both necessary to keep employees up to date on how to control erosion, sediment, spills, and other pollutant runoff. Ask your workers frequently if they know what to do—and why—regarding stormwater management on the job site.

4.9.9 Groundwater Protection

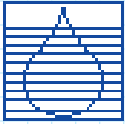

Sampling runoff from construction and other sites is sometimes conducted to determine whether pollutants in the runoff can contaminate groundwater or surface water.

Groundwater protection is important throughout Kentucky because of the high numbers of residents depending on underground water supplies for drinking water. Groundwater protection plans are required for certain activities, such as storing and handling bulk quantities of fertilizers and pesticides, or applying fertilizers or pesticides for commercial purposes.



Definition

Construction site development often involves the storage or use of products that can contaminate groundwater. Groundwater Protection Plans (GPPs) are required for any operation that applies pesticides or fertilizers for commercial purposes, applies pesticides or fertilizers to maintain public rights-of-way, or stores or handles bulk quantities (i.e., 55 gallons or 100 lbs) of pesticides or fertilizers for commercial purposes.

Purpose

Groundwater protection measures are essential for ensuring that the storage, handling, or use of pesticides, fertilizers, or other hazardous products does not contaminate groundwater. These measures are particularly important when materials are transported, handled, or stored in areas with karst features (e.g., sinkholes, disappearing streams).

Implementation

The storage, handling, and use of pesticides or fertilizers at construction sites must be conducted in accordance with a GPP. For small construction sites, this can be accomplished under a Generic GPP, which is a GPP that can be applied to similar activities conducted at different locations. A template for preparing GPPs can be found on the KYDOW Web pages at <http://water.ky.gov/gw/gwprotection/gwplans>. The KYTC has a template for developing a GPP posted at www.kytc.state.ky.us/EnvAnalysis/Stormwaterquality/PDF/Appendix_1-6.pdf.

GPPs are documents that describe and establish a series of practices designed to prevent groundwater pollution. In general, GPPs should be in place before beginning to store, handle, or use pesticides, fertilizers, or other products that could contaminate groundwater. The plans should contain the following:

- General information regarding the facility and its operation, including the name of the facility, the address of the facility, and the name of the person responsible for implementing the plan.
- Identification of all pesticide and fertilizer storage, handling, and application activities.
- Identification of all practices chosen to protect groundwater from pollution, such as storing products indoors, under a roof, or other protected place (see the Material Delivery, Storage, and Use fact sheet in this section); following manufacturer's directions for handling and applying products, reporting of spills, and so on.

- An implementation schedule for the practices selected for the plan.
- A description of and implementation schedule for employee training necessary to ensure implementation of the plan (see the Employee Training fact sheet in this section).
- An inspection schedule requiring regular inspections as needed to ensure that all practices established are in place and properly functioning.
- A certification by the person responsible for implementing the plan or a duly authorized representative that the plan complies with the requirements of Kentucky laws and regulations, and that the person responsible for implementing the plan has reviewed the terms of the plan and will implement its provisions.

More information on Groundwater Protection Plans can be found on the Internet at www.lrc.state.ky.us/kar/401/005/037.htm. The groundwater protection practices chosen for a GPP can include but are not limited to equipment design, operational procedures, preventive maintenance techniques, construction techniques, personnel training, spill response capabilities, alternative materials or processes, implementation of new technology, modification of facility or equipment, spill prevention control and countermeasure plans, hazardous waste contingency plans, runoff or infiltration control systems, and siting considerations.

The nature of the pollutant and the hydrogeologic characteristics at or near the location of the activity must be considered in selecting practices to protect groundwater for the activities identified in the plan. At a minimum, the plan must require that

- Loading and unloading areas have spill prevention and control procedures and operation procedures designed to prevent groundwater pollution. Spill containment and cleanup equipment must be readily accessible.
- Any person using existing floor drains must evaluate those floor drains to determine if they discharge to an on-site sewage disposal system, to a closed-loop collection or recovery system, or to a waste treatment system permitted under the KPDES.

If drains are identified that do not discharge to an on-site sewage disposal system, a closed-loop collection or recovery system, or a waste treatment system permitted under the KPDES, that person must terminate the discharge or connect it to an on-site sewage disposal system, a closed-loop collection or recovery system, or a waste treatment system permitted under the KPDES. No person may install a floor drain unless it is connected to an on-site sewage disposal system, closed-loop collection or recovery system, or a waste treatment system permitted under the KPDES.

- Any person using a tank or sump must prepare and implement good housekeeping practices, operating procedures, operator training, and spill response procedures. In addition, any person using a tank or sump must consider leak control devices, secondary containment, integrity testing, mechanical inspections, and overflow protection devices. Additional containment is not required for sumps and tanks that are used solely to provide secondary containment.
- Any person who constructs a new surface impoundment, lagoon, pit, or ditch that will contain a pollutant must evaluate the site's hydrogeology and must design and operate it to minimize discharges to soil. However, soils may be used to construct liners under appropriate conditions. All necessary and appropriate measures must be taken to prevent groundwater pollution. The person must consider the use of liners, secondary containment, leak detection devices, and other appropriate and effective control systems. Additional containment is not required for new surface impoundments, lagoons, pits, and ditches that are used solely to provide secondary containment.

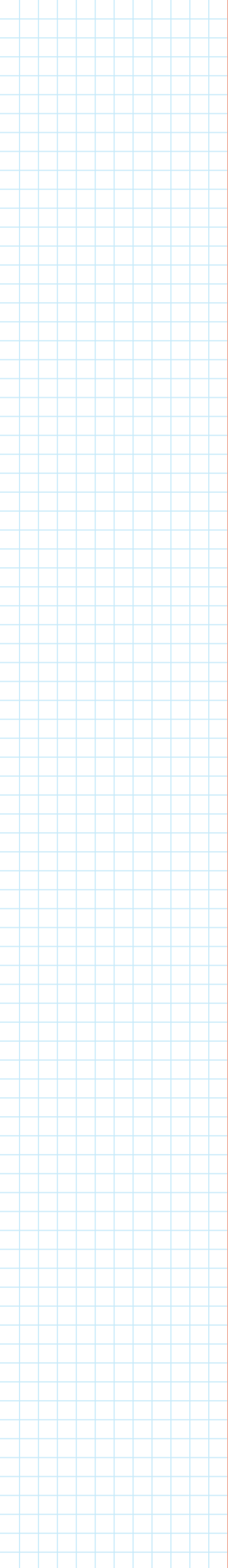

Appendix A

Example Stormwater Pollution Prevention Plan
for a Construction Project in Kentucky

CONSTRUCTION SITE STORMWATER POLLUTION PREVENTION PLAN

This Stormwater Pollution Prevention Plan (SWPPP) narrative and the attached plan sheets address requirements of the Kentucky Division of Water's KPDES KYR10 permit.

Plan Preparer: Paul E. Planpreparer, P.E. 859.111.1121, pplanpreparer@planengineers.com

Date: January 1, 20XX

1. CONTACT INFORMATION AND SITE DESCRIPTION

Project Name and Location

Starshader Apartments
21 Broadview Avenue
Olympia Springs, KY 40000

Site Owner Name and Contact Information

Joe Pine, President
Pine Grove Development LLC
11 Main Street
Salt Lick KY 40000
606.111.1112
Joe.Pine@pinegrove.com

Construction Site SWPPP Manager and Contact Information

Mark Smith, General Contractor
DBA Smith Homebuilders
10 Main Street
Owingsville, KY 40360
859.111.1111
MSmith@Smithhomebuilders.com

Project Start and End Dates

Start: January 1, 20XX
End: December 31, 20XX

Description – Existing Site Conditions, Purpose, and Types of Soil Disturbing Activities

The site is near Olympia Springs in Bath County, KY. The existing site is grassed pasture with rolling slopes <5%, some cedars, and no mature trees in the area to be developed. Soils are sandy loam with good drainage. No streams are on the property. Rocky Creek is about 450 ft downgrade. It is not an impaired water body according to the Kentucky Division of Water. No threatened or endangered species or historical sites were found on the property. This project will consist of three low-rise, attached apartment buildings with adjacent parking facilities. Soil disturbing activities will include: installing a stabilized construction entrance, installing downgradient silt fencing, initial clearing and grubbing, installation of other erosion and sediment controls, general grading, excavation for the sediment pond, storm sewer, utilities, and building foundations; construction of roadside drainage swales, roads, and parking areas; and preparation for final seeding and landscaping.

Site Area and Disturbed Acreage

The site is approximately 11.0 acres, of which 9.8 acres will be disturbed by construction activities. No offsite borrow, fill, or cleared areas are associated with this project.

Sequence and Schedule of Major Project Activities

| Construction Activity | Dates | Schedule Considerations |
|--|----------------|---|
| Work crew orientation | Jan 1 – 7 | Pre-project briefing to review permits, plans, schedule, and staffing. |
| Construction access – install entrance to site, initial construction routes, initial areas designated for vehicle parking | Jan 8 – 15 | This is the first land-disturbing activity. Minimal clearing/grading will be done to install stabilized #2 rock site exit with geotextile underliner, at least 50 ft long. Downgradient silt fences will be installed below areas to be cleared, grubbed, graded, or cut/filled. Do-not-disturb areas will be marked off. |
| Sediment traps and barriers – basins, traps, sediment fences, outlet protection | Jan 8 – 15 | ID locations and install temporary sediment traps as needed to intercept flow. Build basins prior to upgradient work where possible, and seed/mulch/blanket slopes immediately. Relocate and reinstall silt fences as necessary prior to upgradient work. Maintain and remove sediment as necessary. |
| Runoff and run-on controls – diversion ditches or berms, perimeter dikes | Jan 8 – 15 | Install controls as needed to divert clean flows around or through site. Key practices will be installed after the installation of principal sediment traps and before land grading. Additional runoff control measures may be installed during grading. |
| Land clearing and grading—site preparation (cutting, filling, and grading, sediment traps, barriers, diversions, drains, surface roughening) | Jan 16 – 31 | Major clearing and grading will begin after installation of principal sediment and runoff control measures, and additional control measures will be installed as grading continues. Borrow and disposal areas will be cleared as needed. Trees and buffer areas around streams, sinkholes, and other protected areas will be marked for preservation. |
| Runoff conveyance system - storm drains, channels, inlet and outlet protection, slope drains | Feb 1 – 28 | Inlet and outlet protection measures will be installed as needed. Drainage ditches will be stabilized immediately with sod or seed with erosion control blanket. Slope drains will be installed as indicated on site drawings. A minimum 25 ft vegetated buffer will be maintained around all streams and sinkholes. |
| Surface stabilization—temporary and permanent seeding, mulching, sodding, riprap | Mar 1 – 15 | All disturbed areas will be graded and stabilized as soon as possible. Stabilization will begin within 14 days on areas of the site where construction has permanently or temporarily ceased. Temporary and permanent stabilization will comply with the Stormwater Manual. Erosion control blankets and turf reinforcement mats will be used on slopes in accordance with the Stormwater Manual. |
| Building construction—buildings, utilities, paving | Mar 1 – Jun 30 | During construction, erosion and sedimentation control measures will be installed as needed, such as construction entrances and downgradient silt fences and sediment traps. Areas at final grade not in the immediate construction area will be seeded/mulched as soon as possible. |
| Landscaping and final stabilization—topsoiling, trees and shrubs, permanent seeding, mulching, sodding. | Jul 1 – 31 | This is the last construction phase. All remaining disturbed areas will be stabilized, including borrow and spoil areas. Temporary control structures will be removed and the area will be seeded and mulched. |

2. LOCATION AND SITE DESCRIPTION, MAPS, AND DRAWINGS (ALSO ATTACHED)

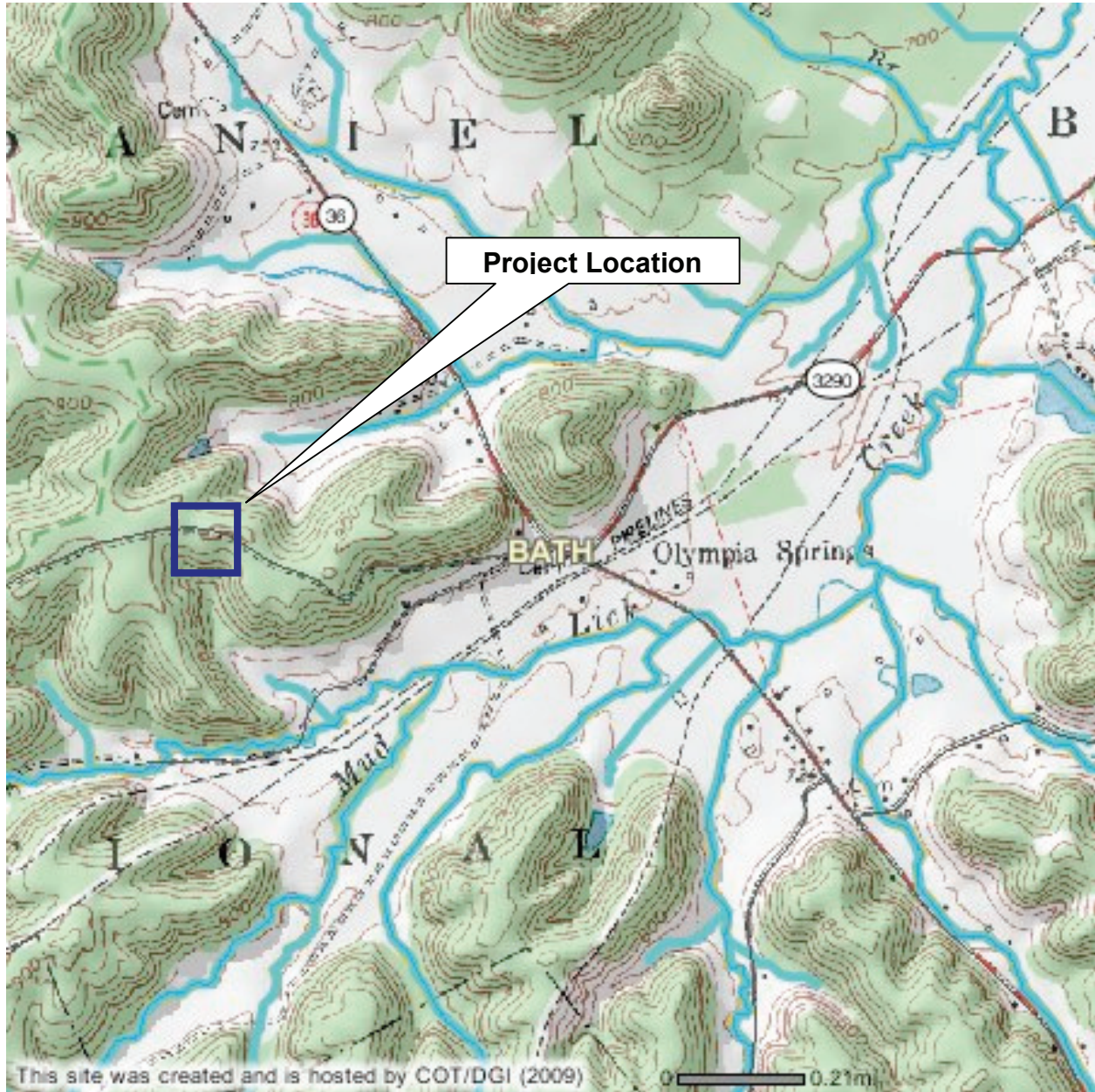

Starshader Apartments Project Location Map (NOTE: Pipeline has been retired from service, and removed)

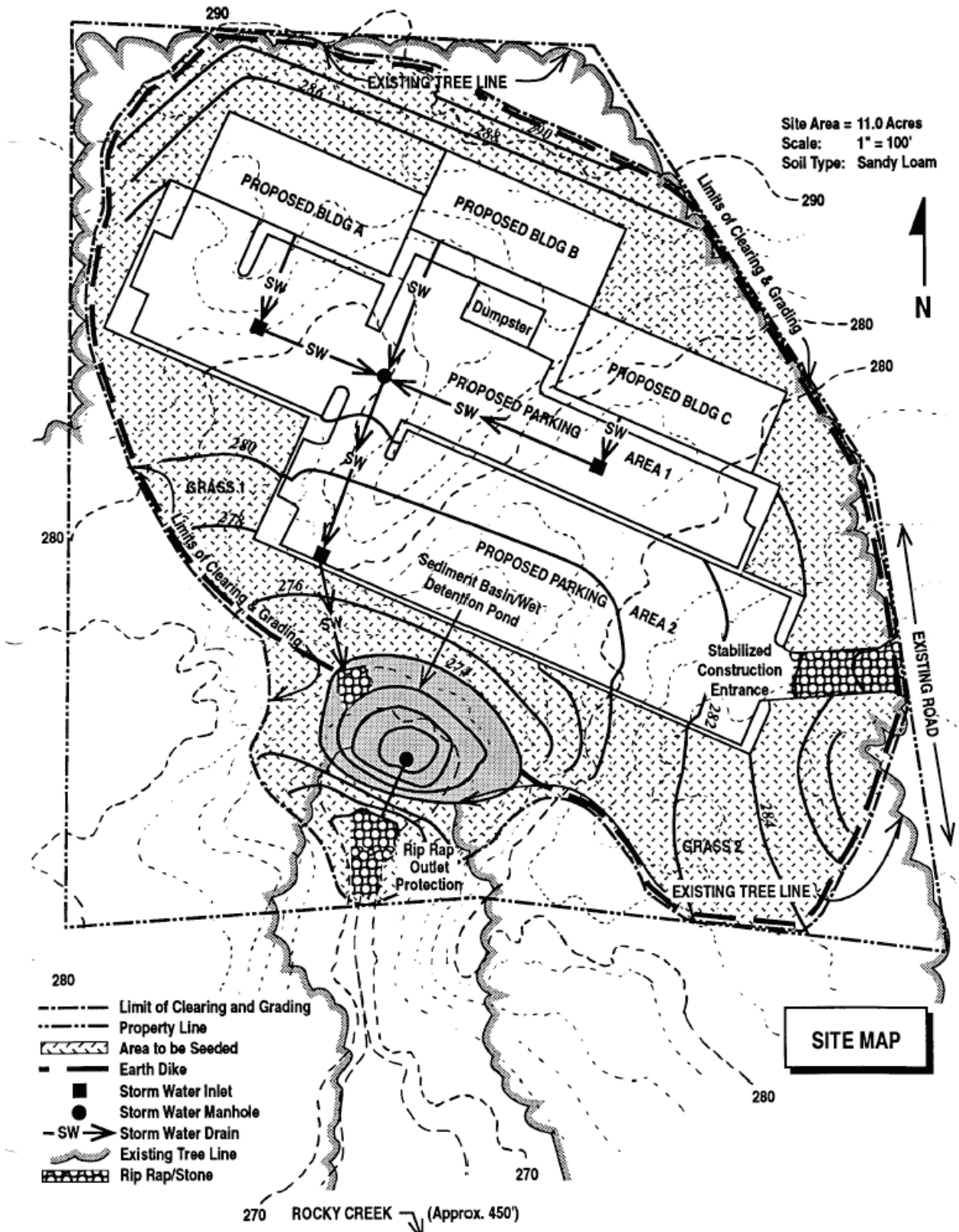

Site Plan Showing Pre/Post Construction Topography, Construction, Drainage Features, and BMPs (See additional plan sheets for BMP design details, notes, and other stormwater management info)

Name of Receiving Waters

The entire site will drain into Rocky Creek, which is approximately 450 feet from the site. There are no sinkholes, wetlands, springs, or streams on the site.

Receiving Waters Classification and Status

Rocky Creek is designated as Warmwater Aquatic Habitat and Primary/Secondary Contact Recreation, and is not listed on the Kentucky impaired waters (303d) list. There is no TMDL for Rocky Creek. No threatened and endangered species are present on the site or downstream from the project discharge.

Potential Sources of Pollutants

Sediment from land clearing and grading; fertilizer; concrete washout water; paint wash water; oil/fuel/grease from equipment; sanitary waste; trash/debris.

3. EROSION PREVENTION AND SEDIMENT CONTROL MEASURES

Limits of Disturbance and Project Phasing

Approximately 9.8 acres will be disturbed during construction. Land disturbance activities will be phased to minimize the amount of soil exposed and the length of exposure time. The overall objective will be to achieve final grades as quickly as possible, and to stabilize all areas with seed, mulch or blankets/mats within 14 days after final grade is achieved, or after grading work has been suspended on that portion of the site.

Stabilization Practices

Temporary Stabilization – Top soil stockpiles and disturbed portions of the site where construction activity stops for 14 days or more will be stabilized with temporary seed or straw mulch no later than 14 days from the last construction activity in that area (portion) of the site. Seeding rates will be consistent with the Kentucky Erosion Prevention and Sediment Control Field Guide. Lime and fertilizer will be applied only when necessary, after soil testing. After seeding, each area shall be mulched with at least 4,000 pounds per acre of blown or hand-scattered straw. The straw will be netted down or crimped into place by a disk harrow with the blades set straight. Slopes will be covered with blankets or mats consistent with the Kentucky Construction BMP Planning and Technical Specifications Manual. Areas of the site which are to be paved will be temporarily stabilized by applying geotextile and stone sub-base until bituminous pavement can be applied. Dust will be controlled by water sprayed from a tanker truck as needed during dry weather.

Permanent Stabilization – Disturbed portions of the site where construction activities are completed will be stabilized with permanent seed no later than 14 days after completion of grading in that area. Seed and mulch will be applied consistent with the Kentucky Erosion Protection and Sediment Control Field Guide. Lime and fertilizer will be applied only if needed. After seeding, each area will be mulched with 4,000 pounds per acre of straw. The straw mulch will be netted down or crimped into place by a disk harrow with blades set straight. Slopes will be covered with erosion control blankets or turf reinforcement mats consistent with the Kentucky Construction BMP Planning and Technical Specifications Manual. Ditches will be triple-seeded and lined with erosion control blanket or turf reinforcement matting.

Structural Practices (See Attached Plan Sheets for Additional Details and Drawings)

Earthen Berm – will be constructed along the uphill perimeter (north) of the site. This berm will divert clean run-on water around the construction site. Another berm on the east side will collect runoff from the disturbed area and direct the runoff to the sediment basin. Berms will be seeded and mulched immediately after construction. Erosion control blankets will be used on top of seed in berm ditches with slopes of 5-10 percent. Turf reinforcement mats will be used in berm ditches with slopes exceeding 10 percent. Blankets or mats will be used on slopes in accordance with the Kentucky Construction BMP Planning and Technical Specifications Manual.

Sediment Traps – will be sited and constructed as needed, according to the attached drawings and through field adaptations to changing grades and emergence of gullies that need to be controlled. Traps will consist of rock or rock bag berms across concentrated flow areas and be designed to intercept, detain, and settle out these flows. Traps installed as field adaptations will be logged on SWPPP & plans.

Sediment Basin – will be constructed at the common drainage location on the south side of the construction site. The basin will be formed by constructing an embankment across an existing gully and excavating a storage pond with a volume of 134 cubic yards for each upgradient disturbed acre. The basin will drain through a perforated corrugated metal riser and outlet pipe to a riprap outlet apron. The riser will have ½ inch holes 3-6 inches apart, with no large holes or slots in the lower two-thirds of the riser. Sediment will be removed before the basin is one-third full. Also, once construction activities are nearly complete, the accumulated sediment will be removed from the basin. The sediment basin and surrounding area will be seeded and mulched immediately after construction. Blankets or mats will be used on slopes in accordance with the Kentucky Construction BMP Planning and Technical Specifications Manual. Basin outlet will be protected with a rock berm during construction, to pond up and detain incoming flow.

Inlet Protection Measures – will be used to detain, pond, and settle (or filter) out sheet and concentrated flows moving toward curb, drop, or other inlets. Inlet protection structures will consist of rock bags, #2 rock berms, trenched in silt fence on framing, or commercial devices.

Outlet Protection Measures – will be used where culverts discharge to ditches or channels, and consist of turf reinforcement matting over triple seeding, erosion control blanket over triple seeding, or channel lining, depending on the scour flows and consistent with the Kentucky Division of Water's BMP Technical Specifications Manual.

Ditch Check Dams – will be installed as needed to control ditch downcutting, trap sediment, and stabilize ditches. Check dam installation will be consistent with the Kentucky Erosion Protection and Sediment Control Field Guide and BMP Technical Specifications Manual.

Site Runoff Management

Sediment will be prevented from leaving the site to the maximum extent practicable. Storm water drainage will be provided mostly by grassed swales, with sheet runoff from parking lots and building drains leading to a permanent stormwater pond on the south side of the site. The pond will be modified for sediment retention during the construction phase. Runoff will be diverted onto undisturbed vegetated areas and revegetated areas where possible for infiltration. Landscaped areas with no buildings or roads will be brought to grade and planted/seeded/mulched within 14 days. Two acres of the site, along existing drainage areas and some slopes, will be flagged off-limits to equipment and remain in its current natural state. When construction is complete the entire site will drain to the south side detention basin (the detention basin will be in the location of the temporary sediment basin). The areas on the sides of the basin will be seeded and mulched after construction. The detention pond is designed with a permanent pool volume of 1,333 cubic yards. This is equivalent to one inch of runoff for the drainage area. It is expected that this detention pond design – along with other site controls – will remove 80 percent removal of total suspended solids in the site runoff for the 2-year, 24-hour storm (see attached plan sheets for design details and calculations). The pond has been designed by a professional engineer to keep peak flow rates from the two and ten year 24-hour storms at pre-development rates. The outlet of the detention basin will be stabilized by a riprap apron. The inlet will be modified during construction by installation of a 3 ft high rock berm around the inlet to increase detention time and sediment removal. The berm will be removed after the entire site is stabilized.

4. OTHER CONTROL MEASURES

Offsite Vehicle Tracking

A stabilized #2 and larger rock construction exit with geotextile underliner will be installed to help reduce vehicle tracking of sediments at all exits onto paved roads. The stabilized exit will be 100 ft where

possible, and at least 50 ft in length. The paved street adjacent to the site entrance will be swept/cleaned daily if necessary to remove any excess mud, dirt, or rock tracked from the site. The rock exit will be grubbed lightly or otherwise maintained as needed to clear (shake down) dry mud. Dump trucks hauling material from the construction site will be covered with a tarpaulin.

Waste Disposal

Waste Materials – All waste materials that may leach pollutants (paint and paint containers, caulk tubes, oil/grease containers, liquids of any kind, soluble materials, etc.) will be collected and stored in a covered metal dumpster rented from the ABC Waste Management Company, which is a licensed solid waste management company. The dumpster will meet all local and state solid waste management regulations. Construction debris and other wastes that do not leach pollutants will be recycled or deposited in a covered or open-topped dumpster. The dumpster will be emptied when full, and the contents will be hauled to an approved site. No construction waste materials will be buried onsite. All personnel will be instructed regarding the correct procedure for waste disposal. Notices stating these practices will be posted in the office trailer and Mark Smith, the individual who manages the day-to-day site operations, will be responsible for seeing that these procedures are followed.

Hazardous Waste – All waste materials will be disposed of in the manner specified by local or state regulation or by the manufacturer. Site personnel will be instructed in these practices and Mark Smith, the individual who manages day-to-day site operations, will be responsible for seeing that these practices are followed

Sanitary Waste – Portable toilets will be used on site for sanitary wastes. All sanitary waste will be collected from the portable units as needed to prevent excessive odors and overflows by the TIDEE Company, a licensed sanitary waste management contractor, as required by local regulation. Portable units will be placed away from storm drain inlets, ditches, creeks, and other water bodies

Timing of Control Measures

As indicated in the Sequence of Major Activities, the stabilized construction exit, earthen diversion berm, silt fences / sediment barriers, and sediment basin will be constructed prior to clearing or grading of any other portions of the site. Sediment traps will be constructed as needed in areas where gulying occurs. Ditches will be built and triple seeded/mulched (or blanketed) after construction. Areas where construction activity temporarily ceases for more than 14 days will be stabilized with temporary seed and/or mulch within 14 days of the last disturbance. Once construction activity ceases permanently in an area, that area will be seeded and mulched within 14 days. Temporary controls in permanently stabilized areas, such as silt fences, sediment barriers, ditch checks, temporary sediment traps, etc., will be removed. Controls will remain in place until all vegetation is established and ditches are stable.

5. OTHER STATE AND LOCAL PLANS

Certification of Compliance with Federal, State, and Local Regulations

This Stormwater Pollution Prevention Plan reflects Kentucky Division of Water requirements for stormwater management and erosion and sediment control. To ensure compliance, this plan was prepared in accordance with [the Kentucky BMP Planning and Technical Specifications Manual](#). There are no other local, state, or federal permits (e.g., Clean Water Act Section 404 dredge/fill permit, KY DOW Section 401 Water Quality Certification, KY DOW Floodplain Permit, etc.) needed for this project.

6. MAINTENANCE PROCEDURES

Stormwater, Erosion, and Sediment Control Maintenance Practices

Maintenance of all BMPs at the site will be handled by Mark Smith of Smith Homebuilders, who has been trained on construction site BMPs at workshops sponsored by the KY DOW and the Kentucky Erosion Protection and Sediment Control (KEPSC) Program. Other workers on-site will be trained in BMP

installation, maintenance, and good housekeeping by Mr. Smith. These are the inspection and maintenance practices that will be used to maintain erosion and sediment controls:

- Less than ½ of the site will be cleared of vegetation at one time; areas at final grade will be seeded and mulched within 14 days.
- All measures will be maintained in good working order; if a repair is necessary, it will be initiated within 24 hours of being reported. This information will be logged on the SWPPP/BMP Plan
- Silt fences will be inspected for bypassing, overtopping, undercutting, depth of sediment, tears, and to ensure attachment to secure posts. Bypasses will be repaired immediately.
- Built-up sediment will be removed from behind the silt fence before it has reached halfway up the height of the fence.
- The sediment basin will be inspected for depth of sediment, and built-up sediment will be removed when it reaches 30 percent of the design capacity and at the end of the job.
- Diversion dikes and berms will be inspected and any breaches promptly repaired. Areas that are eroding or scouring will be repaired and re-seeded / mulched as needed.
- Temporary and permanent seeding and mulching will be inspected for bare spots, washouts, and healthy growth. Bare or eroded areas will be repaired as needed.

7. INSPECTION PROCEDURES

Stormwater, Erosion, and Sediment Control Inspection Practices

Inspection of all BMPs at the site will be handled by Mark Smith of Smith Homebuilders, who has been trained on inspecting construction site BMPs at workshops sponsored by the KY DOW and the Kentucky Erosion Protection and Sediment Control (KEPSC) Program.

- All erosion prevention and sediment control measures will be inspected at least once every two weeks and within 24 hours following any rain of one-half inch or more.
- Inspections will be conducted by Mark Smith, who has been trained by the KY DOW and KEPSC. Mr. Smith will train three people who will be responsible for assisting in the inspections and installing, maintaining, and repairing the controls on the site.
- Inspection reports will be written, signed, dated, and kept on file for two years. They will be kept on file at the site office trailer, along with this Stormwater Pollution Prevention Plan.

8. NON-STORMWATER DISCHARGES

It is expected that the following non-storm water discharges will occur from the site during construction:

- Water from water line flushings.
- Pavement wash waters (where no spills or leaks of toxic or hazardous materials have occurred).
- Uncontaminated groundwater and rain water (from dewatering during excavation).

All non-storm water discharges will be directed to a sediment basin, filter bag, or filter fence enclosure in a flat vegetated infiltration area prior to discharge, to remove sediment and other contaminants.

The materials or substances listed below are expected to be present onsite during construction:

- Concrete
- Detergents
- Paints (enamel and latex)
- Metal Studs
- Concrete
- Tar
- Fertilizers
- Petroleum Based Products
- Cleaning Solvents
- Wood
- Masonry Block
- Roofing Shingles

installation, maintenance, and good housekeeping by Mr. Smith. These are the inspection and maintenance practices that will be used to maintain erosion and sediment controls:

- Less than ½ of the site will be cleared of vegetation at one time; areas at final grade will be seeded and mulched within 14 days.
- All measures will be maintained in good working order; if a repair is necessary, it will be initiated within 24 hours of being reported. This information will be logged on the SWPPP/BMP Plan
- Silt fences will be inspected for bypassing, overtopping, undercutting, depth of sediment, tears, and to ensure attachment to secure posts. Bypasses will be repaired immediately.
- Built-up sediment will be removed from behind the silt fence before it has reached halfway up the height of the fence.
- The sediment basin will be inspected for depth of sediment, and built-up sediment will be removed when it reaches 30 percent of the design capacity and at the end of the job.
- Diversion dikes and berms will be inspected and any breaches promptly repaired. Areas that are eroding or scouring will be repaired and re-seeded / mulched as needed.
- Temporary and permanent seeding and mulching will be inspected for bare spots, washouts, and healthy growth. Bare or eroded areas will be repaired as needed.

7. INSPECTION PROCEDURES

Stormwater, Erosion, and Sediment Control Inspection Practices

Inspection of all BMPs at the site will be handled by Mark Smith of Smith Homebuilders, who has been trained on inspecting construction site BMPs at workshops sponsored by the KY DOW and the Kentucky Erosion Protection and Sediment Control (KEPSC) Program.

- All erosion prevention and sediment control measures will be inspected at least once every two weeks and within 24 hours following any rain of one-half inch or more.
- Inspections will be conducted by Mark Smith, who has been trained by the KY DOW and KEPSC. Mr. Smith will train three people who will be responsible for assisting in the inspections and installing, maintaining, and repairing the controls on the site.
- Inspection reports will be written, signed, dated, and kept on file for two years. They will be kept on file at the site office trailer, along with this Stormwater Pollution Prevention Plan.

8. NON-STORMWATER DISCHARGES

It is expected that the following non-storm water discharges will occur from the site during construction:

- Water from water line flushings.
- Pavement wash waters (where no spills or leaks of toxic or hazardous materials have occurred).
- Uncontaminated groundwater and rain water (from dewatering during excavation).

All non-storm water discharges will be directed to a sediment basin, filter bag, or filter fence enclosure in a flat vegetated infiltration area prior to discharge, to remove sediment and other contaminants.

The materials or substances listed below are expected to be present onsite during construction:

- Concrete
- Detergents
- Paints (enamel and latex)
- Metal Studs
- Concrete
- Tar
- Fertilizers
- Petroleum Based Products
- Cleaning Solvents
- Wood
- Masonry Block
- Roofing Shingles

- Materials and equipment necessary for spill cleanup will be kept in the material storage area. Equipment and materials will include but not limited to brooms, dust pans, mops, rags, gloves, kitty litter, sand, sawdust, and plastic and metal trash containers.
- All spills will be cleaned up immediately after discovery.
- The spill area will be kept well ventilated and personnel will wear appropriate protective clothing to prevent injury from contact with a hazardous substance.
- Spills of toxic or hazardous material will be reported to the appropriate state/local agency.
- The spill prevention plan will be adjusted as needed to prevent spills from reoccurring and improve spill response and cleanup.
- Mark, Smith, the site superintendent responsible for the day-to-day site operations, will be the spill prevention and cleanup coordinator. He will designate at least three other people onsite to receive spill prevention/cleanup training and assist in cleanups. Their names will be posted in the material storage area and in the office trailer outside.

9. PERMITTEE CERTIFICATIONS

SWPPP Files, Updates, and Amendments

This SWPPP Plan and related documents (e.g., NOI, inspection reports) will be kept on file at the construction site by Mark Smith, the Site Manager. The SWPPP will be updated by the Owner and/or Site Manager to reflect any and all significant changes in site conditions, selection of BMPs, the presence of any unlisted potential pollutants on site, or changes in the Site Manager, contractor, subcontractors, or other key information. Updates and amendments will be made in writing within 7 days and will be appended to the original SWPPP and available for review.

Stormwater Pollution Prevention Plan Certification

I certify under penalty of law that this document and all attachments were prepared under my direction or supervision in accordance with a system designed to assure that qualified personnel properly gathered and evaluated the information submitted. Based on my inquiry of the person or persons who manage the system, or those persons directly responsible for gathering the information, the information submitted is, to the best of my knowledge and belief, true, accurate, and complete. I am aware that there are significant penalties for submitting false information, including the possibility of fine and imprisonment for knowing violations.

Signed: _____

Joe Pine, President
Pine Grove Development LLC

Date: _____

Kentucky Construction Site Stormwater Inspection Report

| General Information | | | |
|--|--|----------------|--|
| Project Name | | | |
| KPDES Tracking No. | | Location | |
| Date of Inspection | | Start/End Time | |
| Inspector's Name(s) | | | |
| Inspector's Title(s) | | | |
| Inspector's Contact Info | | | |
| Inspector's Qualifications | | | |
| Describe present work phase | | | |
| Type of Inspection: | | | |
| <input type="checkbox"/> Regular Weekly <input type="checkbox"/> Regular Bi-Weekly <input type="checkbox"/> Pre-Storm Event <input type="checkbox"/> During Storm <input type="checkbox"/> Post-Storm Event | | | |
| Weather Information | | | |
| Has there been a storm event since the last inspection? <input type="checkbox"/> Yes <input type="checkbox"/> No If yes, provide: Start Date & Time: Storm Duration (hrs): Approximate Amount of Precipitation (in): | | | |
| Weather at time of this inspection? <input type="checkbox"/> Clear <input type="checkbox"/> Cloudy <input type="checkbox"/> Rain <input type="checkbox"/> Sleet <input type="checkbox"/> Fog <input type="checkbox"/> Snowing <input type="checkbox"/> High Winds <input type="checkbox"/> Other Temperature: _____ | | | |
| Have any discharges of sediment or other pollutants occurred since the last inspection? <input type="checkbox"/> Yes <input type="checkbox"/> No If yes, describe: | | | |
| Are there any discharges of sediment or pollutants at the time of inspection? <input type="checkbox"/> Yes <input type="checkbox"/> No If yes, describe: | | | |

Site-specific BMPs

Number the structural and non-structural BMPs identified in your SWPPP on your site map and list them below (add as many BMPs as necessary. Describe corrective actions initiated, date completed, and note the person that completed the work in the Corrective Action Log.

| | BMP Type or Name | BMP Installed? | Maintenance Required? | Corrective Action Needed and Notes |
|----|------------------|--|--|------------------------------------|
| 1 | | <input type="checkbox"/> Yes <input type="checkbox"/> No | <input type="checkbox"/> Yes <input type="checkbox"/> No | |
| 2 | | <input type="checkbox"/> Yes <input type="checkbox"/> No | <input type="checkbox"/> Yes <input type="checkbox"/> No | |
| 3 | | <input type="checkbox"/> Yes <input type="checkbox"/> No | <input type="checkbox"/> Yes <input type="checkbox"/> No | |
| 4 | | <input type="checkbox"/> Yes <input type="checkbox"/> No | <input type="checkbox"/> Yes <input type="checkbox"/> No | |
| 5 | | <input type="checkbox"/> Yes <input type="checkbox"/> No | <input type="checkbox"/> Yes <input type="checkbox"/> No | |
| 6 | | <input type="checkbox"/> Yes <input type="checkbox"/> No | <input type="checkbox"/> Yes <input type="checkbox"/> No | |
| 7 | | <input type="checkbox"/> Yes <input type="checkbox"/> No | <input type="checkbox"/> Yes <input type="checkbox"/> No | |
| 8 | | <input type="checkbox"/> Yes <input type="checkbox"/> No | <input type="checkbox"/> Yes <input type="checkbox"/> No | |
| 9 | | <input type="checkbox"/> Yes <input type="checkbox"/> No | <input type="checkbox"/> Yes <input type="checkbox"/> No | |
| 10 | | <input type="checkbox"/> Yes <input type="checkbox"/> No | <input type="checkbox"/> Yes <input type="checkbox"/> No | |
| 11 | | <input type="checkbox"/> Yes <input type="checkbox"/> No | <input type="checkbox"/> Yes <input type="checkbox"/> No | |
| 12 | | <input type="checkbox"/> Yes <input type="checkbox"/> No | <input type="checkbox"/> Yes <input type="checkbox"/> No | |
| 13 | | <input type="checkbox"/> Yes <input type="checkbox"/> No | <input type="checkbox"/> Yes <input type="checkbox"/> No | |
| 14 | | <input type="checkbox"/> Yes <input type="checkbox"/> No | <input type="checkbox"/> Yes <input type="checkbox"/> No | |
| 15 | | <input type="checkbox"/> Yes <input type="checkbox"/> No | <input type="checkbox"/> Yes <input type="checkbox"/> No | |
| 16 | | <input type="checkbox"/> Yes <input type="checkbox"/> No | <input type="checkbox"/> Yes <input type="checkbox"/> No | |
| 17 | | <input type="checkbox"/> Yes <input type="checkbox"/> No | <input type="checkbox"/> Yes <input type="checkbox"/> No | |
| 18 | | <input type="checkbox"/> Yes <input type="checkbox"/> No | <input type="checkbox"/> Yes <input type="checkbox"/> No | |
| 19 | | <input type="checkbox"/> Yes <input type="checkbox"/> No | <input type="checkbox"/> Yes <input type="checkbox"/> No | |
| 20 | | <input type="checkbox"/> Yes <input type="checkbox"/> No | <input type="checkbox"/> Yes <input type="checkbox"/> No | |

Overall Site Issues: Note BMPs, Implementation, Maintenance and Corrective Action Needs.

| BMP/activity | Installed? | Maintenance Required? | Corrective Action Needed and Notes |
|--|--|--|------------------------------------|
| Are all slopes and disturbed areas not being worked properly stabilized? | <input type="checkbox"/> Yes <input type="checkbox"/> No | <input type="checkbox"/> Yes <input type="checkbox"/> No | |
| Are streams, wetlands, mature trees, etc. protected with barriers or BMPs? | <input type="checkbox"/> Yes <input type="checkbox"/> No <input type="checkbox"/> N/A | <input type="checkbox"/> Yes <input type="checkbox"/> No <input type="checkbox"/> N/A | |
| Are perimeter controls and sediment barriers adequately installed (keyed into substrate) and maintained? | <input type="checkbox"/> Yes <input type="checkbox"/> No | <input type="checkbox"/> Yes <input type="checkbox"/> No | |
| Are discharge points and receiving waters free of any sediment deposits? | <input type="checkbox"/> Yes <input type="checkbox"/> No | <input type="checkbox"/> Yes <input type="checkbox"/> No | |
| Are storm drain inlets properly protected? | <input type="checkbox"/> Yes <input type="checkbox"/> No <input type="checkbox"/> N/A | <input type="checkbox"/> Yes <input type="checkbox"/> No <input type="checkbox"/> N/A | |
| Is the construction exit preventing sediment from being tracked into the street? | <input type="checkbox"/> Yes <input type="checkbox"/> No | <input type="checkbox"/> Yes <input type="checkbox"/> No | |
| Is trash/litter from work areas collected and placed in covered waste containers? | <input type="checkbox"/> Yes <input type="checkbox"/> No | <input type="checkbox"/> Yes <input type="checkbox"/> No | |
| Are washout facilities (e.g., paint, stucco, concrete) available, clearly marked, and maintained? | <input type="checkbox"/> Yes <input type="checkbox"/> No <input type="checkbox"/> N/A | <input type="checkbox"/> Yes <input type="checkbox"/> No <input type="checkbox"/> N/A | |
| Are vehicle and equipment fueling, cleaning, and maintenance areas free of spills, leaks, or any other material? | <input type="checkbox"/> Yes <input type="checkbox"/> No <input type="checkbox"/> N/A | <input type="checkbox"/> Yes <input type="checkbox"/> No <input type="checkbox"/> N/A | |
| Are materials that are potential stormwater contaminants stored inside or under cover? | <input type="checkbox"/> Yes <input type="checkbox"/> No | <input type="checkbox"/> Yes <input type="checkbox"/> No | |
| Are non-stormwater discharges (e.g., wash water, dewatering) properly controlled? | <input type="checkbox"/> Yes <input type="checkbox"/> No <input type="checkbox"/> N/A | <input type="checkbox"/> Yes <input type="checkbox"/> No <input type="checkbox"/> N/A | |
| Other management practices inspected or needed (explain): | | | |

Non-Compliance

Describe any incidents of non-compliance not described above:

CERTIFICATION STATEMENT

“I certify under penalty of law that this document and all attachments were prepared under my direction or supervision in accordance with a system designed to assure that qualified personnel properly gathered and evaluated the information submitted. Based on my inquiry of the person or persons who manage the system, or those persons directly responsible for gathering the information, the information submitted is, to the best of my knowledge and belief, true, accurate, and complete. I am aware that there are significant penalties for submitting false information, including the possibility of fine and imprisonment for knowing violations.”

Print name and title: _____

Signature: _____ **Date:** _____

Appendix B

Example Site Plan Drawings



GENERAL NOTES:

1. THE SITE PLAN IS BASED ON THE SURVEY DATA AND THE EXISTING CONDITIONS AS SHOWN ON THE PLANS. THE DESIGNER HAS CONDUCTED VISUAL INSPECTIONS AND PHOTOGRAPHS OF THE SITE AND HAS FOUND NO OBVIOUS OBSTRUCTIONS TO THE PROPOSED DEVELOPMENT.

2. THE PROPOSED DEVELOPMENT IS SUBJECT TO THE APPROVAL OF THE LOCAL GOVERNMENT AND THE STATE DEPARTMENT OF TRANSPORTATION AND PUBLIC SAFETY.

3. THE PROPOSED DEVELOPMENT IS SUBJECT TO THE APPROVAL OF THE LOCAL GOVERNMENT AND THE STATE DEPARTMENT OF TRANSPORTATION AND PUBLIC SAFETY.

4. THE PROPOSED DEVELOPMENT IS SUBJECT TO THE APPROVAL OF THE LOCAL GOVERNMENT AND THE STATE DEPARTMENT OF TRANSPORTATION AND PUBLIC SAFETY.

5. THE PROPOSED DEVELOPMENT IS SUBJECT TO THE APPROVAL OF THE LOCAL GOVERNMENT AND THE STATE DEPARTMENT OF TRANSPORTATION AND PUBLIC SAFETY.

6. THE PROPOSED DEVELOPMENT IS SUBJECT TO THE APPROVAL OF THE LOCAL GOVERNMENT AND THE STATE DEPARTMENT OF TRANSPORTATION AND PUBLIC SAFETY.

7. THE PROPOSED DEVELOPMENT IS SUBJECT TO THE APPROVAL OF THE LOCAL GOVERNMENT AND THE STATE DEPARTMENT OF TRANSPORTATION AND PUBLIC SAFETY.

8. THE PROPOSED DEVELOPMENT IS SUBJECT TO THE APPROVAL OF THE LOCAL GOVERNMENT AND THE STATE DEPARTMENT OF TRANSPORTATION AND PUBLIC SAFETY.

9. THE PROPOSED DEVELOPMENT IS SUBJECT TO THE APPROVAL OF THE LOCAL GOVERNMENT AND THE STATE DEPARTMENT OF TRANSPORTATION AND PUBLIC SAFETY.

10. THE PROPOSED DEVELOPMENT IS SUBJECT TO THE APPROVAL OF THE LOCAL GOVERNMENT AND THE STATE DEPARTMENT OF TRANSPORTATION AND PUBLIC SAFETY.

SHEET NO. 1
 DATE: 10/1/2010
 PROJECT: SWPPP PLAN SHEET
 DRAWN BY: [Name]
 CHECKED BY: [Name]

SWPPP PLAN SHEET

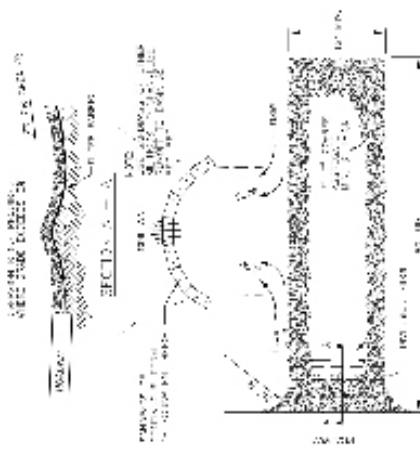

NOTE: THE VEGETATIVE FILTER STRIP SHALL BE MAINTAINED AS SUCH THROUGHOUT THE LIFE OF THE PROJECT. THE STRIP SHALL BE RESEEDED AND RE-MULCHED AS NECESSARY TO MAINTAIN THE STRIP'S EFFECTIVENESS.

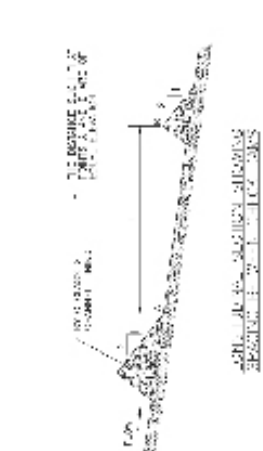

NOTE: THE VEGETATIVE FILTER STRIP SHALL BE MAINTAINED AS SUCH THROUGHOUT THE LIFE OF THE PROJECT. THE STRIP SHALL BE RESEEDED AND RE-MULCHED AS NECESSARY TO MAINTAIN THE STRIP'S EFFECTIVENESS.



NOTE: THE VEGETATIVE FILTER STRIP SHALL BE MAINTAINED AS SUCH THROUGHOUT THE LIFE OF THE PROJECT. THE STRIP SHALL BE RESEEDED AND RE-MULCHED AS NECESSARY TO MAINTAIN THE STRIP'S EFFECTIVENESS.

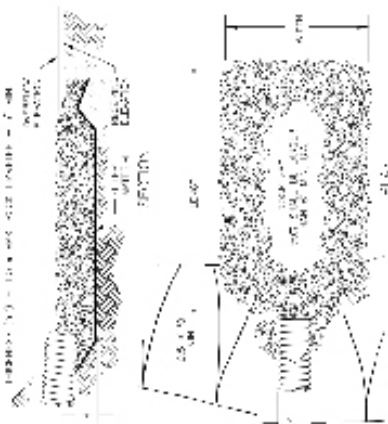

NOTE: THE VEGETATIVE FILTER STRIP SHALL BE MAINTAINED AS SUCH THROUGHOUT THE LIFE OF THE PROJECT. THE STRIP SHALL BE RESEEDED AND RE-MULCHED AS NECESSARY TO MAINTAIN THE STRIP'S EFFECTIVENESS.

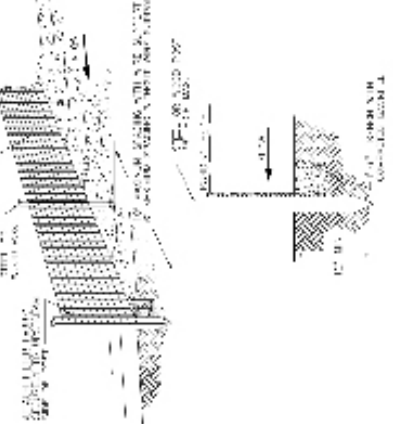

NOTE: THE VEGETATIVE FILTER STRIP SHALL BE MAINTAINED AS SUCH THROUGHOUT THE LIFE OF THE PROJECT. THE STRIP SHALL BE RESEEDED AND RE-MULCHED AS NECESSARY TO MAINTAIN THE STRIP'S EFFECTIVENESS.

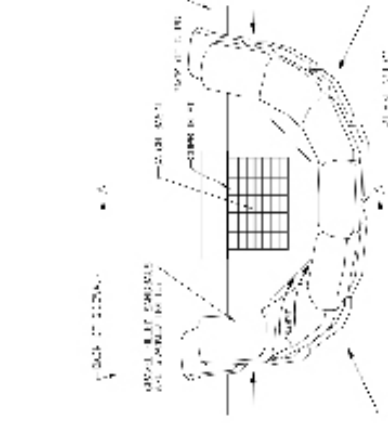

NOTE: THE VEGETATIVE FILTER STRIP SHALL BE MAINTAINED AS SUCH THROUGHOUT THE LIFE OF THE PROJECT. THE STRIP SHALL BE RESEEDED AND RE-MULCHED AS NECESSARY TO MAINTAIN THE STRIP'S EFFECTIVENESS.

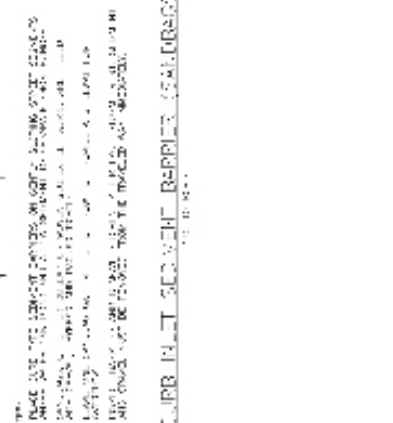

NOTE: THE VEGETATIVE FILTER STRIP SHALL BE MAINTAINED AS SUCH THROUGHOUT THE LIFE OF THE PROJECT. THE STRIP SHALL BE RESEEDED AND RE-MULCHED AS NECESSARY TO MAINTAIN THE STRIP'S EFFECTIVENESS.

**SWPPP
 DETAIL SHEET**

Appendix C

Site Runoff Calculations

General Information

The Universal Soil Loss Equation (USLE) has been used extensively as an acceptable method of computing sheet erosion from farmlands. Modifications have been made in the USLE for determining construction site erosion. The revisions are referred to as RUSLE and are accomplished mainly through adjustments of "urban" vegetation conditions ("C" factors) and the urban best management factors ("P" factors). Soil erosion from rills and gullies is not included in this equation. If gullies are present or a potential problem, further computations may be made to determine additional soil erosion. This is an "estimation" of sheet soil erosion and is not interchangeable with sediment delivery or sediment yield.

The rate of sheet erosion depends on several factors:

- Rainfall energy and intensity
- Soil erodibility
- Land slope and length of slope
- Condition of the soil surface and best management practices in use
- Surface cover involved, such as grass, woodlands, crops, pavement, or no cover at all

These factors are assigned quantitative values to be used for computing soil loss and are found in the following tables.

The Universal Soil Loss Equation equation is $A = R \times K \times (LS) \times C \times P$, where

- **A** = The computed annual soil loss expressed in tons per acre
- **R** = The rainfall factor is the number of erosion index units in a normal year's rain. The average annual erosive rainfall factors (R values) for Kentucky are shown in **Table 1006-1-A**.
- **K** = The soil erodibility factor for selected soils of Kentucky is shown in **Table 1006-1-B**. K is the erosion rate per unit of erosion index for a specific soil.
- **LS** = The slope length factor is the ratio of soil loss from a specific slope length to a 72.6-foot slope of the same soil on a 9 percent gradient. Refer to **Table 1006-1-C** for values of LS.
- **C** = The cropping management factor is the ratio of soil loss from a field with specified cropping management to that of the fallow condition on which the factor K is evaluated. Refer to **Table 1006-1-D** for crop management factors.
- **P** = The best management practice factor is the ratio of soil loss with certain conservation practices to that which results without such practices. Refer to **Table 1006-1-E** for best management practice factors. The annual soil loss in tons per acre may be reduced to cubic yards per acre by use of **Table 1006-1-F** and adjusted for the portion of the year that the soil is actually exposed to soil erosion by use of **Table 1006-1-G**.

Table 1006-1-A
RAINFALL FACTOR, R by COUNTY

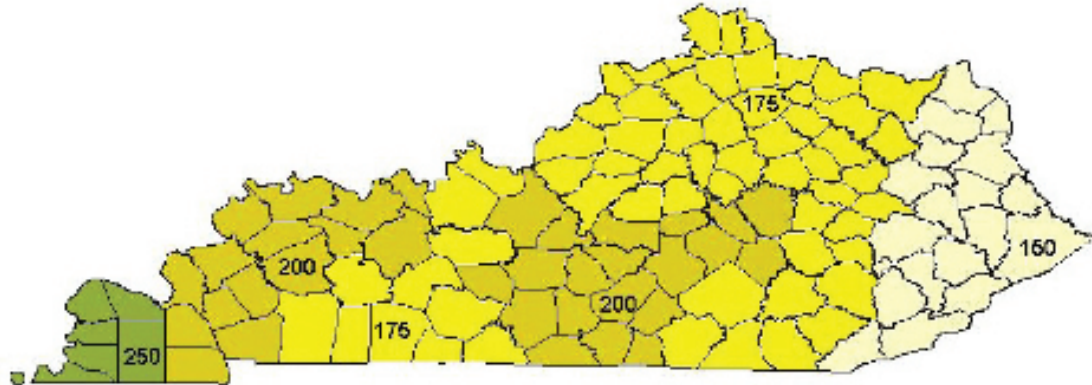

Counties with 150 R Factor

| | | | | |
|-------------------------------------|---------------------------------------|--|-------------------------------|-------------------------|
| Bell Boyd Breathitt Carter | Elliott Floyd Greenup Harlan | Johnson Knott Lawrence Leslie | Letcher Magoffin Martin | Morgan Perry Pike |
|-------------------------------------|---------------------------------------|--|-------------------------------|-------------------------|

Counties with 175 R Factor

| | | | | |
|--|--|--|---|--|
| Allan Anderson Bath Boone Bourbon Bracken Breckinridge Bullitt Butler Campbell Carroll Christian Clark | Clay Estill Fayette Fleming Franklin Gallatin Grant Grayson Harrison Henry Jackson Jefferson Jessamine | Kenton Knox Laurel Lee Lewis Logan Mason McCreary Meade Menifee Mercer Montgomery Muhlenberg | Nelson Nicholas Ohio Oldham Owen Owsley Pendleton Powell Pulaski Robertson Rowan Scott | Shelby Simpson Spencer Todd Trimble Warren Washington Wayne Whitley Wolfe Woodford |
|--|--|--|---|--|

Counties with 200 R Factor

| | | | | |
|--|---|--|---|--|
| Adair Barren Boyle Caldwell Calloway Casey Clinton Crittenden | Cumberland Davies Edmonson Garrard Green Hancock Hardin | Hart Henderson Hopkins Larue Lincoln Livingston Lyon | Madison Marion Marshall McLean Metcalfe Monroe Ohio | Rockcastle Russell Taylor Trigg Union Webster |
|--|---|--|---|--|

Counties with 250 R Factor

| | | | | |
|---------------------|--------|--------|---------|-----------|
| Ballard Carlisle | Fulton | Graves | Hickman | McCracken |
|---------------------|--------|--------|---------|-----------|

**Table 1006-1-B
ERODIBILITY (K FACTORS) AND TEXTURES OF B AND C HORIZONS
FOR SELECTED KENTUCKY SOIL SERIES**

| Soil Series | B Horizon | | C Horizon | |
|--------------|-----------|---------|-----------|---------|
| | Tex. | K Value | Tex. | K Value |
| Armour | sicl | 0.37 | sicl | 0.43 |
| Ashton | sil | 0.43 | sil | 0.43 |
| Avonburg | sil | 0.43 | sic | 0.32 |
| Beasley | sic | 0.28 | c | 0.28 |
| Brandon | sicl | 0.28 | vgrsl | 0.17 |
| Brashear | sic | 0.28 | c | 0.28 |
| Braxton | sicl | 0.28 | sicl | 0.28 |
| Calloway | sic | 0.43 | sic | 0.43 |
| Crider | sicl | 0.32 | sic | 0.28 |
| Cynthiana | sic | 0.28 | rock | --- |
| Donerail | sicl | 0.28 | c | 0.28 |
| Eden | flsic | 0.28 | vflsic | 0.17 |
| Elk | sicl | 0.28 | sicl | 0.28 |
| Fairmont | sic | 0.28 | rock | --- |
| Faywood | sic | 0.28 | sic | 0.28 |
| Grenada | sicl | 0.49 | sil | 0.64 |
| Lakin | fsl | 0.17 | ls | 0.17 |
| Lanton | sic | 0.43 | c | 0.32 |
| Lax | sicl | 0.43 | grcl | 0.32 |
| Loradale | sic | 0.28 | c | 0.28 |
| Loring | sicl | 0.49 | sicl | 0.43 |
| Lowell | sic | 0.28 | c | 0.28 |
| Maury | sic | 0.28 | c | 0.28 |
| McAfee | sic | 0.28 | c | 0.28 |
| Memphis | sicl | 0.49 | sil | 0.49 |
| Mercer | sicl | 0.43 | c | 0.28 |
| Muskingum | sil | 0.28 | cnsil | 0.17 |
| Nicholson | sicl | 0.43 | c | 0.37 |
| Russellville | sicl | 0.43 | c | 0.37 |
| Shelbyville | sicl | 0.28 | sic | 0.28 |
| Wheeling | cl | 0.24 | fsl | 0.24 |
| Woolper | sic | 0.28 | c | 0.28 |
| Zanesville | sicl | 0.28 | l | 0.28 |

(The K value may be increased or decreased as much as 20 percent to adjust for local soil series variations.) Abbreviations of Soil Textures are as follows:

- | | |
|--------------------------|----------------------------------|
| c—clay | sic—silty clay |
| cl—clay loam | sicl—silty clay loam |
| cnsil—channery silt loam | sil—silt loam |
| fsl—fine sandy loam | vflsic—very flaggerly silty clay |
| grsl—gravelly clay loam | vgrsl—very gravelly sandy loam |
| ls—loamy sand | |

Table 1006-1-C
Soil Loss, LS, Along a Slope

$$LS = (\lambda / 72.6)^m \cdot (430 \cdot x^2 + 30 \cdot x + 0.43) / 6.613$$

Where λ = slope length (λ = horizontal length/cos θ or = fill height/sin θ)

θ = slope angle; $x = \sin \theta$

m = 0.3 for slope < 3%, 0.4 for slope = 4%, or 0.5 for slope > 5%

LS Based on Horizontal Length (feet)

| Slope H : V | 10 | 20 | 30 | 40 | 60 | 80 | 100 |
|----------------|-------|-------|-------|-------|-------|-------|-------|
| 50 : 1 | 0.100 | 0.123 | 0.139 | 0.152 | 0.172 | 0.187 | 0.200 |
| 40 : 1 | 0.121 | 0.149 | 0.168 | 0.183 | 0.207 | 0.226 | 0.241 |
| 30 : 1 | 0.159 | 0.196 | 0.221 | 0.241 | 0.272 | 0.297 | 0.317 |
| 25 : 1 | 0.193 | 0.238 | 0.269 | 0.293 | 0.331 | 0.361 | 0.386 |
| 20 : 1 | 0.205 | 0.271 | 0.319 | 0.358 | 0.421 | 0.472 | 0.516 |
| 10 : 1 | 0.432 | 0.610 | 0.748 | 0.863 | 1.057 | 1.221 | 1.365 |
| 8 : 1 | 0.607 | 0.858 | 1.051 | 1.213 | 1.486 | 1.716 | 1.918 |
| 6 : 1 | 0.960 | 1.357 | 1.662 | 1.919 | 2.351 | 2.714 | 3.035 |
| 4 : 1 | 1.880 | 2.659 | 3.257 | 3.761 | 4.606 | 5.318 | 5.946 |

LS Based on Fill Height (feet)

| Slope H : V | 5 | 10 | 20 | 40 | 60 | 80 | 100 |
|----------------|--------|--------|--------|--------|--------|--------|--------|
| 6 : 1 | 1.662 | 2.351 | 3.325 | 4.702 | 5.758 | 6.649 | 7.434 |
| 4 : 1 | 2.659 | 3.761 | 5.318 | 7.521 | 9.212 | 10.637 | 11.892 |
| 2 : 1 | 5.925 | 8.379 | 11.850 | 16.759 | 20.525 | 23.700 | 26.498 |
| 1 : 1 | 11.168 | 15.794 | 22.336 | 31.587 | 38.687 | 44.671 | 49.944 |

| Table 1006-1-D ESTIMATED C FACTORS FOR PROTECTIVE GROUND COVER ON CONSTRUCTION SITES | | |
|---|---------------------|----------|
| Type of Cover | Application Rate | C Factor |
| None (Fallow Ground) | - | 1.0 |
| Temporary Seeding (90% Stand): | | |
| Ryegrass (Perennial Type) | - | 0.05 |
| Ryegrass (Annuals) | | |
| Small Grain | - | 0.05 |
| Millet or Sudan Grass | - | 0.05 |
| Field Bromegrass | - | 0.03 |
| Permanent Seedings (90% Stand): | | |
| (Bluegrass, KY 31 Fescue, etc.) | - | 0.01 |
| Sod (Laid Immediately) | - | 0.01 |
| Mulches: | | |
| Straw or Hay | 2 Tons/acre | 0.25 |
| | 4 Tons/acre | 0.13 |
| | 6 Tons/acre | 0.07 |
| | 10 Tons/acre | 0.02 |
| Wood Chips | 30 Tons/acre | 0.06 |
| Wood Cellulose | 9 Tons/acre | 0.10 |
| Fiberglass | 2 Tons/acre | 0.05 |
| Asphalt Emulsion | 40 Cubic Yards/acre | 0.02 |
| (Fiber matting, excelsior, gravel, and stone may also be used as protective ground cover with an estimated C factor of 0.02 to 0.10 depending upon the amount applied.) | | |
| ESTIMATED C FACTORS FOR SURFACE CONDITIONS WITH NO COVER | | |
| Type of Cover | | C Factor |
| Compact and smooth, scraped with bulldozer or scraper up and downhill | | 1.3 |
| Same condition, except raked with bulldozer root rake up and downhill | | 1.2 |
| Compact and smooth, scraped with bulldozer or scraper along the slope | | 1.2 |
| Same condition, except raked with bulldozer root rake along the slope | | 0.9 |
| Loose as a disked layer | | 1.0 |
| Rough irregular surface equipment tracks in all directions | | 0.9 |
| Loose with rough surface greater than 1 foot deep | | 0.8 |
| Loose with smooth surface greater than 1 foot deep | | 0.9 |

| Table 1006-1-E ESTIMATED BEST MANAGEMENT PRACTICE P FACTORS FOR SEDIMENT BASINS AND SEDIMENT CONTROL SYSTEMS | |
|---|-----------------|
| Situation | P Factor |
| Sediment basin – small, on site | |
| - Receiving sediment from 70% of the site | 0.50 |
| - Receiving sediment from 100% of the site | 0.20 |
| Sediment basin – large, off site | |
| - Downstream below construction site | 0.15 |
| System of diversions and waterways | |
| - Seeded, sodded, riprap as needed | 0.45 |

| Table 1006-1-F FACTORS FOR CONVERTING TONS PER ACRE TO CUBIC YARDS PER ACRE | |
|--|---------------|
| Texture | Factor |
| Sands, loamy sands, sandy loams | 0.70 |
| Sandy clay loams, silt loams, loams, and silty clay loams | 0.87 |
| Clay loams, sandy clays, clay, and silty clays | 1.02 |

| Table 1006-1-G RAINFALL DISTRIBUTION TABLE | | | | |
|---|---|---------------------|---|---------------------|
| Month | Western Half of Kentucky¹ | | Eastern Half of Kentucky¹ | |
| | Per Month | Accumulative | Per Month | Accumulative |
| January | 3 | 3 | 3 | 3 |
| February | 6 | 9 | 4 | 7 |
| March | 7 | 16 | 6 | 13 |
| April | 9 | 25 | 6 | 19 |
| May | 12 | 37 | 8 | 27 |
| June | 12 | 49 | 13 | 40 |
| July | 15 | 64 | 20 | 60 |
| August | 13 | 77 | 20 | 80 |
| September | 7 | 84 | 9 | 89 |
| October | 6 | 90 | 4 | 93 |
| November | 5 | 95 | 3 | 96 |
| December | 5 | 100 | 4 | 100 |
| SUM | 100 | | 100 | |

¹ Division line is approximately a north/south line from Owenton to Albany.

Appendix D

Construction Site Inspection Checklist and Report Form

Kentucky Construction Site Stormwater Inspection Report

| General Information | | | |
|--|--|----------------|--|
| Project Name | | | |
| KPDES Tracking No. | | Location | |
| Date of Inspection | | Start/End Time | |
| Inspector's Name(s) | | | |
| Inspector's Title(s) | | | |
| Inspector's Contact Info | | | |
| Inspector's Qualifications | | | |
| Describe present work phase | | | |
| Type of Inspection: | | | |
| <input type="checkbox"/> Regular Weekly <input type="checkbox"/> Regular Bi-Weekly <input type="checkbox"/> Pre-Storm Event <input type="checkbox"/> During Storm <input type="checkbox"/> Post-Storm Event | | | |
| Weather Information | | | |
| Has there been a storm event since the last inspection? <input type="checkbox"/> Yes <input type="checkbox"/> No If yes, provide: Start Date & Time: Storm Duration (hrs): Approximate Amount of Precipitation (in): | | | |
| Weather at time of this inspection? <input type="checkbox"/> Clear <input type="checkbox"/> Cloudy <input type="checkbox"/> Rain <input type="checkbox"/> Sleet <input type="checkbox"/> Fog <input type="checkbox"/> Snowing <input type="checkbox"/> High Winds <input type="checkbox"/> Other Temperature: _____ | | | |
| Have any discharges of sediment or other pollutants occurred since the last inspection? <input type="checkbox"/> Yes <input type="checkbox"/> No If yes, describe: | | | |
| Are there any discharges of sediment or pollutants at the time of inspection? <input type="checkbox"/> Yes <input type="checkbox"/> No If yes, describe: | | | |

Site-specific BMPs

Number the structural and non-structural BMPs identified in your SWPPP on your site map and list them below (add as many BMPs as necessary. Describe corrective actions initiated, date completed, and note the person that completed the work in the Corrective Action Log.

| | BMP Type or Name | BMP Installed? | Maintenance Required? | Corrective Action Needed and Notes |
|----|------------------|--|--|------------------------------------|
| 1 | | <input type="checkbox"/> Yes <input type="checkbox"/> No | <input type="checkbox"/> Yes <input type="checkbox"/> No | |
| 2 | | <input type="checkbox"/> Yes <input type="checkbox"/> No | <input type="checkbox"/> Yes <input type="checkbox"/> No | |
| 3 | | <input type="checkbox"/> Yes <input type="checkbox"/> No | <input type="checkbox"/> Yes <input type="checkbox"/> No | |
| 4 | | <input type="checkbox"/> Yes <input type="checkbox"/> No | <input type="checkbox"/> Yes <input type="checkbox"/> No | |
| 5 | | <input type="checkbox"/> Yes <input type="checkbox"/> No | <input type="checkbox"/> Yes <input type="checkbox"/> No | |
| 6 | | <input type="checkbox"/> Yes <input type="checkbox"/> No | <input type="checkbox"/> Yes <input type="checkbox"/> No | |
| 7 | | <input type="checkbox"/> Yes <input type="checkbox"/> No | <input type="checkbox"/> Yes <input type="checkbox"/> No | |
| 8 | | <input type="checkbox"/> Yes <input type="checkbox"/> No | <input type="checkbox"/> Yes <input type="checkbox"/> No | |
| 9 | | <input type="checkbox"/> Yes <input type="checkbox"/> No | <input type="checkbox"/> Yes <input type="checkbox"/> No | |
| 10 | | <input type="checkbox"/> Yes <input type="checkbox"/> No | <input type="checkbox"/> Yes <input type="checkbox"/> No | |
| 11 | | <input type="checkbox"/> Yes <input type="checkbox"/> No | <input type="checkbox"/> Yes <input type="checkbox"/> No | |
| 12 | | <input type="checkbox"/> Yes <input type="checkbox"/> No | <input type="checkbox"/> Yes <input type="checkbox"/> No | |
| 13 | | <input type="checkbox"/> Yes <input type="checkbox"/> No | <input type="checkbox"/> Yes <input type="checkbox"/> No | |
| 14 | | <input type="checkbox"/> Yes <input type="checkbox"/> No | <input type="checkbox"/> Yes <input type="checkbox"/> No | |
| 15 | | <input type="checkbox"/> Yes <input type="checkbox"/> No | <input type="checkbox"/> Yes <input type="checkbox"/> No | |
| 16 | | <input type="checkbox"/> Yes <input type="checkbox"/> No | <input type="checkbox"/> Yes <input type="checkbox"/> No | |
| 17 | | <input type="checkbox"/> Yes <input type="checkbox"/> No | <input type="checkbox"/> Yes <input type="checkbox"/> No | |
| 18 | | <input type="checkbox"/> Yes <input type="checkbox"/> No | <input type="checkbox"/> Yes <input type="checkbox"/> No | |
| 19 | | <input type="checkbox"/> Yes <input type="checkbox"/> No | <input type="checkbox"/> Yes <input type="checkbox"/> No | |
| 20 | | <input type="checkbox"/> Yes <input type="checkbox"/> No | <input type="checkbox"/> Yes <input type="checkbox"/> No | |

Overall Site Issues: Note BMPs, Implementation, Maintenance and Corrective Action Needs.

| BMP/activity | Installed? | Maintenance Required? | Corrective Action Needed and Notes |
|--|--|--|------------------------------------|
| Are all slopes and disturbed areas not being worked properly stabilized? | <input type="checkbox"/> Yes <input type="checkbox"/> No | <input type="checkbox"/> Yes <input type="checkbox"/> No | |
| Are streams, wetlands, mature trees, etc. protected with barriers or BMPs? | <input type="checkbox"/> Yes <input type="checkbox"/> No <input type="checkbox"/> N/A | <input type="checkbox"/> Yes <input type="checkbox"/> No <input type="checkbox"/> N/A | |
| Are perimeter controls and sediment barriers adequately installed (keyed into substrate) and maintained? | <input type="checkbox"/> Yes <input type="checkbox"/> No | <input type="checkbox"/> Yes <input type="checkbox"/> No | |
| Are discharge points and receiving waters free of any sediment deposits? | <input type="checkbox"/> Yes <input type="checkbox"/> No | <input type="checkbox"/> Yes <input type="checkbox"/> No | |
| Are storm drain inlets properly protected? | <input type="checkbox"/> Yes <input type="checkbox"/> No <input type="checkbox"/> N/A | <input type="checkbox"/> Yes <input type="checkbox"/> No <input type="checkbox"/> N/A | |
| Is the construction exit preventing sediment from being tracked into the street? | <input type="checkbox"/> Yes <input type="checkbox"/> No | <input type="checkbox"/> Yes <input type="checkbox"/> No | |
| Is trash/litter from work areas collected and placed in covered waste containers? | <input type="checkbox"/> Yes <input type="checkbox"/> No | <input type="checkbox"/> Yes <input type="checkbox"/> No | |
| Are washout facilities (e.g., paint, stucco, concrete) available, clearly marked, and maintained? | <input type="checkbox"/> Yes <input type="checkbox"/> No <input type="checkbox"/> N/A | <input type="checkbox"/> Yes <input type="checkbox"/> No <input type="checkbox"/> N/A | |
| Are vehicle and equipment fueling, cleaning, and maintenance areas free of spills, leaks, or any other material? | <input type="checkbox"/> Yes <input type="checkbox"/> No <input type="checkbox"/> N/A | <input type="checkbox"/> Yes <input type="checkbox"/> No <input type="checkbox"/> N/A | |
| Are materials that are potential stormwater contaminants stored inside or under cover? | <input type="checkbox"/> Yes <input type="checkbox"/> No | <input type="checkbox"/> Yes <input type="checkbox"/> No | |
| Are non-stormwater discharges (e.g., wash water, dewatering) properly controlled? | <input type="checkbox"/> Yes <input type="checkbox"/> No <input type="checkbox"/> N/A | <input type="checkbox"/> Yes <input type="checkbox"/> No <input type="checkbox"/> N/A | |
| Other management practices inspected or needed (explain): | | | |

Non-Compliance

Describe any incidents of non-compliance not described above:

CERTIFICATION STATEMENT

“I certify under penalty of law that this document and all attachments were prepared under my direction or supervision in accordance with a system designed to assure that qualified personnel properly gathered and evaluated the information submitted. Based on my inquiry of the person or persons who manage the system, or those persons directly responsible for gathering the information, the information submitted is, to the best of my knowledge and belief, true, accurate, and complete. I am aware that there are significant penalties for submitting false information, including the possibility of fine and imprisonment for knowing violations.”

Print name and title: _____

Signature: _____ **Date:** _____

Appendix E

US Army Corps of Engineers

Clean Water Act Section 404 Summary

U.S. Army Corps of Engineers

**BACKGROUND ON DREDGE AND FILL/WETLANDS REQUIREMENTS FOR
CONSTRUCTION ACTIVITIES**

DEFINITIONS

Dredged Material: Material that is excavated or dredged from waters of the United States.

Fill Material: Material placed in waters of the United States where the material has the effect of:

- Replacing any portion of a water of the United States with dry land, or
- Changing the bottom elevation of any portion of a water of the United States.

Examples of fill material include rock, sand, soil, clay, plastics, construction debris, wood chips, overburden from mining or other excavation activities, and materials used to create any structure or infrastructure in waters of the United States. The term "fill material" does not include trash or garbage.

Incidental Fallback. Redeposit of small volumes of dredged material that is incidental to excavation activity in waters of the United States when such material falls back to substantially the same place as the initial removal. Examples of incidental fallback include soil that is disturbed when dirt is shoveled and the back-spill from a bucket falls into substantially the same place from which it was initially removed.

Waters of the United States (United States Waters). See 40 CFR Part 122.2 for the complete definition. Waters include, but are not limited to:

- All waters that are currently used, or were used in the past, or may be susceptible to use in interstate or foreign commerce, including all waters which are subject to ebb and flow of the tide,

- All interstate waters including interstate wetlands, and

All other waters such as intrastate lakes, rivers, streams (including intermittent streams), mudflats, sandflats, wetlands, sloughs, prairie potholes, wet meadows, playa lakes, or natural ponds, the use, degradation or destruction of which could affect interstate or foreign commerce.

Wetlands. Areas inundated or saturated by surface or ground water at a frequency and duration sufficient to support, and that under normal circumstances do

support, a prevalence of vegetation typically adapted for life in saturated soil conditions. Wetlands generally include swamps, marshes, bogs, and similar areas.

ACRONYMS

US ACE - United States Army Corps of Engineers

CWA - Clean Water Act

NWP - Nationwide Permit

PCN - Preconstruction Notification

APPLICABILITY

US ACE defines discharges of dredged material at 33 CFR 323. These discharges, which require permits under Section 404 of the CWA, include:

The addition of dredged material to a specified discharge site located in waters of the United States; the runoff or overflow from a contained land or water disposal area; and any addition, including redeposit other than incidental fallback, of dredged material, including excavated material, into waters of the United States that is incidental to any activity, including mechanized land clearing, ditching, channelization, or other excavation.

US ACE also defines discharges of fill material at 33 CFR 323. These discharges, which require permits under Section 404 of the CWA, include: placement of fill necessary for the construction of any structure or infrastructure in a water of the United States; building of any structure, infrastructure, or impoundment in waters of the United States requiring rock, sand, dirt, or other material for its construction; site-development fills in waters of the United States for recreational, industrial, commercial, residential, or other uses; causeways or road fills, dams and dikes, artificial islands, beach nourishment, levees, and artificial reefs; property protection and/or reclamation devices such as rip rap, groins, seawalls, breakwaters, and revetments; fill for structures such as sewage treatment facilities; intake and outfall pipes associated with power plants and subaqueous utility lines; placement of fill material in waters of the United States for construction or maintenance of any liner, berm, or other infrastructure associated with solid waste landfills; and placement of overburden, slurry, or tailings or similar mining-related materials in waters of the United States. Contact the state environmental or permitting office and the US ACE District Office to determine whether permits are required for the construction project.

SECTION 404 PERMIT PROCESS REQUIREMENTS

Section 404 requires that no discharge of dredged or fill material be permitted if a practicable alternative exists that is less damaging to the aquatic environment or if the nation's waters would be significantly degraded. When applying for a permit, a wetlands mitigation must be performed to show that the project: avoided wetland impacts where practicable; minimized potential impacts

to wetlands; and will provide compensation for any remaining, unavoidable impacts through activities to restore or create wetlands.

US ACE may issue permits, after notice and opportunity for public hearings, for the discharge of dredged or fill material into waters of the United States at specified disposal sites. Prior to issuing Section 404 permits, state approval must also be obtained (Section 401 certification). There are two types of Section 404 permits: general permits and individual permits. For discharges that have only minimal adverse effects, US ACE issues general permits. General permits may be issued on a nationwide, regional, or state basis for particular categories of activities. Attachment C includes a list of current Nationwide Permits (NWP). Individual permits are usually required for activities with potentially significant impacts.

General Permit Process. An NWP may require that the US ACE District Engineer (DE) of the construction activity be notified in a preconstruction notification (PCN). If required, the PCN should be submitted as early as possible. Within 30 days, the DE will determine whether the PCN is complete and may request additional information. The PCN review process will not begin until all required information is submitted. Construction activity may not begin until one of the following occurs:

- (1) Notification that the activity may proceed is received from the DE. This notification may include special conditions imposed on the specific construction activity.
- (2) Notification that an individual permit is required is received from the DE, and the individual permit is issued.
- (3) Forty-five days have passed since the DE received the complete PCN and no written notice has been received from the DE.

The text of the NWPs should be reviewed to assess whether a particular NWP applies to the construction project (see 67 FRN 2020 or the on-line guide at http://www.usace.army.mil/CECW/Pages/nw_permits.aspx). Some items to check include:

NWP use limits (e.g., NWP 19 Minor Dredging only applies if the site dredges less than 25 cubic yards); and

Applicable waters (e.g., NWP 13 Bank Stabilization does not apply to special aquatic sites (i.e., sanctuaries and refuges, wetlands, mud flats, vegetated shallows, coral reefs, and riffle and pool complexes)).

If the construction activity is covered under an NWP, the site must comply with the general conditions listed for the permit. The US ACE District Office or state environmental department should be contacted for information on regional and state general permits.

Individual Permit Process. The following steps need to be completed to obtain an individual permit:

Application. To receive a Section 404 individual permit, operators must complete an Application for Department of Army Permit (available on line at: http://www.usace.army.mil/CECW/Pages/reg_permit.aspx). US ACE requires, among other things, that permit applicants describe the project and its purpose, the reasons for discharging dredged or fill material, types of material being discharged (and volume of each type in cubic yards), and the surface area of wetlands or other waters filled (in acres). Applicants must also submit one set of drawings showing location and character of proposed activity. The application is submitted to the DE having jurisdiction over the location of the proposed activity. (Note that states may contact the US ACE in conjunction with granting state approval for the project. The application process varies by state; contact the state and US ACE District Office for details.)

Public Notice. US ACE will issue a public notice once the complete permit application has been received. The notice includes the proposed activity, location, and potential environmental impacts.

Comment Period. The public comment period lasts between 15-30 days, depending on the proposed activity. The application and comments are reviewed by the US ACE and other interested federal and state agencies, organizations, and individuals. US ACE also determines whether an Environmental Impact Statement is necessary.

Public Hearing. Citizens may request that US ACE conduct a public hearing; however, public hearings are not usually held.

Permit Evaluation. COE, along with states and other federal agencies, evaluates the permit application, taking into account the comments received.

Permit Award or Denial. Based on the steps above, US ACE may either approve or deny the application.

Environmental Assessment and Statement of Findings. The *Statement of Finding* document explains how the permit decision was made. This document is made available to the public.

The above steps are a basic example of the requirements to obtain an individual permit. The process may require additional steps such as a pre-application meeting with the US ACE district engineer or state officials or negotiation of mitigation plans.

Notification Requirements for USACE and KDOW Section 404 Permits

| Activity | USACE Permit # | Notification to USACE and KDOW Section 404 Permits | Application for a KDOW WQC is required if the following conditions occur: |
|---|----------------|---|---|
| Drift Removal | 3 (ii) | <ul style="list-style-type: none"> ■ Notification is required if the “One Step” method of drift removal cannot be used. | When the project does not qualify under the USACE nationwide permit. |
| Beaver Dam Removal | None | <ul style="list-style-type: none"> ■ Notification is not required for this activity | Notification is not required for this activity. |
| Sediment Removal from Structures | 3 (ii) | <ul style="list-style-type: none"> ■ Work area extends further than 200 feet in any direction from the structure. | More than 200 feet of stream length will be affected. |
| | 19 | <ul style="list-style-type: none"> ■ More than 25 cubic yards of material are removed. | When the project does not qualify under the USACE nationwide permit. |
| Embankment Repair and/or Protection | 13 | <ul style="list-style-type: none"> ■ Length of bank stabilization activity is more than 500 feet. ■ On average, more than one (1) cubic yard per foot of fill is placed below the ordinary high water mark. | Length of bank stabilization activity affects more than 500 feet of stream or using asphalt, creek rock or rip rap. |
| Scour/Erosion Repair to Bridge Elements | 3 (ii) | <ul style="list-style-type: none"> ■ Work area extends more than 200 feet in any direction from the structure. | More than 200 feet of stream length will be affected. |
| | 18 | <ul style="list-style-type: none"> ■ More than 25 cubic yards of material is placed below or removed from below the ordinary high water mark. ■ More than 1/10 acre of special aquatic site (i.e., wetlands, vegetated shallows, riffle/pool complex), is affected. | When the project does not qualify under the USACE nationwide permit or is more than 300 feet. |
| Bridge and Culvert Replacement | 3 (i) | <ul style="list-style-type: none"> ■ Notification is not required for this activity unless one or more of the General Conditions is not met. | More than 300 feet of stream length will be affected. |
| Temporary Construction, Access and Dewatering | 33 | <ul style="list-style-type: none"> ■ A Notification is required for each project. ■ A Restoration Plan is required for each project. | If the project is more than 300 feet. |
| Minor Discharges | 18 | <ul style="list-style-type: none"> ■ More than 25 cubic yards of material is placed below or removed from below the ordinary high water mark. ■ More than 1/10 acre of special aquatic site (i.e., wetlands, vegetated shallows, riffle/pool complex), is affected. | If the project is greater than 300 feet. |
| Minor Dredging | 19 | <ul style="list-style-type: none"> ■ More than 25 cubic yards of material are removed. | When the project does not qualify under the USACE nationwide permit. |
| Residential Developments | 29 | <ul style="list-style-type: none"> ■ More than 1/2 acre of wetland or other aquatic resource is affected. ■ Work extends more than 300 linear feet of stream bed. | Work extends more than 300 linear feet of stream bed. |
| Reshaping Existing Drainage Ditches | 41 | <ul style="list-style-type: none"> ■ Reshaping greater than 500 linear feet of drainage ditch. ■ Reshaping drainage ditch increases capacity of ditch or drains additional waters of the U.S. | When the project does not qualify under the USACE nationwide permit. |
| Stormwater Management Facilities | 43 | <ul style="list-style-type: none"> ■ More than 1/2 acre of wetland or other aquatic resource is affected. ■ Work extends for more than 300 linear feet of stream bed. ■ When expanding or constructing SWM facilities. | When the project does not qualify under the USACE nationwide permit. |

Appendix F

Definitions

Unless specifically defined in this section, words or phrases are usually interpreted so as to give them the meaning they have in common usage.

1-year Frequency Storm - A storm event defined to be 2.5 inches in 24 hours.

2-year, 24-hour event - The maximum 24-hour precipitation event with a probable recurrence interval of once in two (2), years, respectively, as defined by the National Weather Service and Technical Paper No. 40, "Rainfall Frequency Atlas of the U.S., May 1961, or equivalent regional or rainfall probability information developed there from.

2-year Frequency Storm - A storm event with a fifty (50) percent chance of being equaled or exceeded in a given year. Defined in general to be 3.3 inches in 24 hours.

5-year Frequency Storm - A storm event with a twenty (20) percent chance of being equaled or exceeded in any given year. Defined in general to be 4.1 inches in 24 hours.

10-year Frequency Storm - A storm event with a ten (10) percent chance of being equaled or exceeded in any given year. Defined in general to be 4.8 inches in 24 hours.

25-year Frequency Storm - A storm event with a four (4) percent chance of being equaled or exceeded in any given year. Defined in general to be 5.5 inches in 24 hours.

100-year Flood Elevation - The elevation of the 100-year flood at any given location.

100-year Frequency Storm - A storm event with a one (1) percent chance of being equaled or exceeded in any given year. Defined in general to be 6.5 inches in 24 hours.

305 (b) Report - means the approved biennial Clean Water Act Integrated Water Quality Report to Congress, §305(b).

401 Water Quality Certification - means the certification issued by a state in response to a federally issued permit. In this case the certification DOW issues in response to a COE §404 permit.

404 Permit - means the permit issued by the United States Army Corps of Engineers (USACE) for activities that discharge dredged or fill material into navigable waters.

500-year Flood Elevation - The elevation of the 500-year flood at any given location.

500-year Frequency Storm - A storm event with a one-fifth (1/5) of one (1) percent chance of being equaled or exceeded in any given year. Defined in general to be 7.6 inches in 24 hours

Active Channel - The area of the stream that is most subject to water flow and that includes the portion of the channel below the top-of-bank.

As-Built Certification - As-built, field-verified plans signed and sealed by a registered professional engineer and/or a registered land surveyor, both licensed to practice in the State of Kentucky, showing contours, elevations, grades, locations, drainage and hydraulic structures, and detention basin volumes.

As Soon As Practical - for the purposes of this permit means at the earliest possible time when external factors such as inclement weather would not prevent completion of the task.

Bankfull Elevation - for the purposes of this permit means the water level, or stage, at which a stream, river, or lake is at the top of its banks and any further rise would result in water moving into the flood plain (NOAA Glossary).

Base Flood Elevation (BFE) - The 100-year flood elevation at any given location.

Best Management Practices (BMPs) - means schedules of activities, prohibitions of practices, maintenance procedures, and other management practices to prevent or reduce the discharge of pollutants to waters of the Commonwealth. BMPs also include treatment requirements, operating procedures, and practice to control plant site runoff, spillage or leaks, sludge or waste disposal, or drainage from raw material storage. (EPA CGP)

Blue-Line Stream - Any stream that is shown on a 7.5 minute USGS quadrangle map, unless determined otherwise by the Kentucky Division of Water or US Army Corps of Engineers.

Channel - A natural watercourse of perceptible extent, with definite bed and banks to confine and conduct continuously or periodically flowing water (also, see Ditch).

Clearing - The removal of vegetation and/or disturbance of soil prior to grading or excavation in anticipation of construction or other activities. Clearing may also refer to wide area land disturbance in anticipation of non-construction activities; for instance, cleared forested land in order to convert forest land to pasture for wildlife management purposes.

Cold Water Aquatic Habitats or CAH - means those “waters of the Commonwealth” that meet the criterion of 401 KAR 10:031, Section 4(2) and have been listed in 401 KAR 10:026, Section 5.

Commencement of Construction Activities - means the initial disturbance of soils associated with clearing, grading, or excavating activities or other construction-related activities (e.g., stockpiling of fill material). (EPA CGP)

Common Plan of Development or Sale - for the purposes of this permit means any announcement or piece of documentation (e.g., sign, public notice, or hearing, sales pitch, advertisement, drawing, permit application, zoning request, computer design, etc.) or physical demarcation (e.g., boundary signs, lot stakes, surveyor markings, etc.) indicating construction activities may occur on a specific plot. Where discrete construction projects within a larger common plan of development or sale are located 0.25 mile or more apart and the area between the projects is not being disturbed, each individual project can be treated as a separate plan of development or sale provided any interconnecting road, pipeline or utility project that is part of the same “common plan” is not concurrently being disturbed.

Construction and Construction-related activities - include all clearing, grading, excavation, and stockpiling activities that will result in the disturbance of one or more acres of land area. Construction does not include routine earth disturbing activities that are part of the normal day-to-day operation of a completed facility (e.g., daily cover for landfills, maintenance of gravel roads or parking areas, landscape maintenance, etc). Also, it does not include activities under a State or Federal reclamation program to return an abandoned property into an agricultural or open land use.

Construction Related Wastes - Refuse or unused materials that can result from construction activities. Construction related wastes can include, but are not limited to, unused building and landscaping materials, chemicals, litter, sanitary waste, paint waste, and concrete truck washout.

Control Measure - as used in this permit, refers to any BMP or other method used to prevent or reduce the discharge of pollutants to waters of the Commonwealth. (modified EPA CGP)

Conveyance - The capacity of a channel, ditch, or pipe to carry stormwater.

Covenants for Permanent Maintenance of Stormwater Facilities and Best Management Practices - A legal document executed by the property owner, homeowners’ association as owner of record, or other owner of real property which guarantees perpetual and proper maintenance of stormwater facilities and best management practices.

Co-permittees - means when two or more operators are required to jointly file a single Notice of Intent (NOI) to obtain joint authorization. Co-permittees may be found on larger common plans of development or sale

Critical Areas - for the purposes of this permit means areas within 25 feet as measured from the bankfull elevation of the channel, and on a positive slope toward a water of the Commonwealth.

Development - Any land change that alters the hydrologic or hydraulic conditions of any property. Often referred to as “site development.” Development includes, but is not limited to, providing access to a site, clearing of vegetation, grading, earth moving, providing utilities, roads and other services such as parking facilities, stormwater management and erosion control systems, potable water and wastewater systems, altering land forms, or construction or demolition of a structure on the land.

Discharge - when used without qualification means the “discharge of a pollutant.” (EPA CGP)

Discharge of Stormwater Associated with Construction Activity - as used in this permit refers to a discharge of pollutants in stormwater from areas where soil disturbing activities (e.g., clearing, grading, or excavation), construction materials or equipment storage or maintenance (e.g., fill piles, borrow area, concrete truck chute washdown, fueling), or other industrial stormwater directly related to the construction process (e.g., concrete or asphalt batch plants) are located. (EPA CGP)

Disturbed Area - Portion of any site that has been altered from existing conditions, including but not limited to the following: providing access to a site, clearing of vegetation, grading, earth moving, providing utilities and other services such as parking facilities, stormwater management and erosion control systems, potable water and wastewater systems, altering land forms, or construction or demolition of a structure on the land. Also called bare soil area.

Ditch - A man-made watercourse of perceptible extent, usually constructed for the purpose of draining surface water.

Drainage Basin - The area of land, buildings, roads, parking lots, and other surfaces contributing stormwater runoff to a single point.

Drainage System - The system of pipes, channels, culverts, and ditches that convey stormwater from and through public and private land.

Edge of the Receiving Water - for the purposes of this permit is defined as the bankfull elevation of a water of the Commonwealth.

Eligible - means qualified for authorization to discharge stormwater under this general permit. (EPA CGP)

Equivalent Analysis Waiver - means a waiver, available only to “small construction activities” which discharge to non-impaired waters only, that is based on the applicant performance of an equivalent analysis using existing instream concentrations, expected growth in pollutant concentrations from all sources, and a margin of safety.

Erosion - The removal of soil particles by the action of water, wind, ice or other geological agents, whether naturally occurring or acting in conjunction with or promoted by anthropogenic activities or effects.

Excavation - A cavity or hole in the land surface that is caused by the cutting, digging, or scooping and removal of soil, rock, or other materials.

Exceptional Waters or EW - means those “waters of the Commonwealth” that have been listed in Table 2 of 401 KAR 10:030, Section 1(2).

Facility or Activity - means any “point source” or other facility or activity (including land or appurtenances thereto) that is subject to regulation under the KPDES program. (EPA CGP)

Filling - Any deposit or stockpiling of dirt, rocks, stumps, or other natural or man-made solid material.

Final Stabilization - means that: 1. All soil disturbing activities at the site have been completed and either of the two following criteria are met: c. a uniform (e.g., evenly distributed, without large bare areas) perennial vegetative cover with a density of 70 percent of the native background vegetative cover for the area has been established on all unpaved areas and areas not covered by permanent structures, or d. equivalent stabilization measures (such as the use of riprap, gabions, or geotextiles) have been employed. 2. For individual lots in residential construction, final stabilization means, that either: e. The homebuilder has completed final stabilization as specified above, or f. The homebuilder has established temporary stabilization including perimeter controls for an individual lot prior to occupation of the home by the homeowner and informing the homeowner of the need for, and benefits of, final stabilization. 3 For construction projects on land used for agricultural purposes (e.g., pipelines across crop or range land, staging area for highway construction, etc.) final stabilization may be accomplished by returning the disturbed land to its preconstruction agricultural uses. Areas disturbed that were not previously used for agricultural activities, such as buffer strips immediately adjacent to waters of the Commonwealth and areas which are not being returned to their preconstruction agricultural use must meet the final stabilization criteria in item 1. (modified EPA CGP)

Flood - Water from a river, stream, watercourse, lake or other body of standing water that temporarily overflows and inundates adjacent lands and which may affect other lands and activities through increased surface water levels, and/or increased groundwater level.

Floodplain - The relatively flat or lowland area adjoining a river, stream, watercourse, lake, or other body of standing water, which has been or may be covered temporarily by flood water. Floodplains are typically assigned a recurrence interval (i.e., the 100-year floodplain) which defines the magnitude of the flood event that causes the inundation. The 100-year floodplain is the area subject to flood for the 100-year flood.

Flood Proofing - A combination of structural provisions, changes, or adjustments to properties and structures subject to flooding primarily for the reduction or elimination of flood damages to properties, water and sanitary facilities, structures, and contents of buildings in a flood hazard area.

Floodway - That portion of the stream channel and adjacent floodplain required for the passage or conveyance of a 100-year flood discharge without cumulatively increasing the 100-year water surface elevation more than one (1) foot. The floodway is the portion of special flood hazard area characterized by significant depths and velocities.

Floodway Encroachment - Any obstruction, fill, construction, improvement or other alteration that changes the hydraulic characteristics of the regulatory floodway.

Grading - Any clearing, excavating, filling or other disturbance of terrain.

Grading Permit - A permit issued by a local government authorizing the commencement of land disturbing activities.

High Quality Waters or HQW - means those “waters of the Commonwealth” that have categorized by the Division of Water as high quality pursuant to the requirements of 401 KAR 10:030, Section 1(3).

Illicit Discharge - Any discharge to the stormwater system that is not composed entirely of stormwater and not specifically exempted by state or federal regulations. Specifically, floor drains, wastewater treatment system discharges, cesspool discharges, sink drains, and all other non-stormwater discharges to the stormwater system and surface streams are illicit discharges, whether discharged directly or through a pipe, ditch, swale, drain tile, rolling stock, or other man made conveyance.

Impaired Waters or IW - means those “waters of the Commonwealth” that have been categorized by the Division of Water as impaired for applicable designated uses and have been identified pursuant to 33 U.S.C. 1315(b) and listed in the most recently approved 305(b) report.

Impervious Area - Impermeable surfaces which prevent the percolation of water into the soil including, but not limited to, pavement, parking areas and driveways, packed gravel or soil, or rooftops.

Kentucky Pollutant Discharge Elimination System (NPDES) - The program administered by The Commonwealth of Kentucky for the United States Environmental Protection Agency to eliminate or reduce pollutant discharges to the waters of the United States. (See also National Pollutant Discharge Elimination System.)

Lake - An inland body of standing water, usually of considerable size.

Land Disturbing Activity - Any activity on a property that results in a change in the existing soil (both vegetative and non-vegetative) and/or the existing soil topography. Land disturbing activities include, but are not limited to, development, re-development, demolition, construction, reconstruction, clearing, grading, filling, logging and/or tree chipping operations, haul roads associated with the development, and excavation.

Large Construction Activity - is defined at 401 KAR 5:002, Section 1(292). A large construction activity includes clearing, grading, and excavating resulting in a land disturbance that will disturb equal to or greater than five acres of land or will disturb less than five acres of total land area but is part of a larger common plan of development or sale that will ultimately disturb equal to or greater than five acres. Large construction activity does not include routine maintenance that is performed to maintain the original line and grade, hydraulic capacity or original purpose of the site. (modified EPA CGP)

Municipal Separate Storm Sewer System or MS4 - is defined at 401 KAR 5:002, Section 1(188). Means a conveyance or system of conveyances (including roads with drainage systems, municipal streets, catch basins, curbs, gutters, ditches, manmade channels, or storm drains): 1. Owned and operated by a state, city, town, borough, county, parish, district, association, or other public body (created by or pursuant to State law) having jurisdiction over disposal of sewage, industrial wastes, stormwater, or other wastes, including special districts under State law such as a sewer district, flood control district or drainage district, or similar entity, or an Indian tribe or an authorized Indian tribal organization, or a designated and approved management agency under section 208 of the CWA that discharges to waters of the Commonwealth; 2. Designed or used for collecting or conveying stormwater; 3. Which is not a combined sewer; and 4. Which is not part of Publicly Owned Treatment Works (POTW) as defined in 40 CFR § 122.2. (modified from EPA CGP)

National Pollutant Discharge Elimination System (NPDES) - The program administered by the United States Environmental Protection Agency to eliminate or reduce pollutant discharges to the waters of the United States. In Kentucky, known as the Kentucky Pollutant Discharge Elimination System.

Natural Resources Conservation Service (NRCS) - An organization within the U.S. Department of Agriculture that has published standard drainage procedures in the form of Technical Release No. 55. Formerly known as the Soil Conservation Service (SCS).

New Project - means the “commencement of construction activities” occurs after the effective date of this permit. (EPA CGP)

Ongoing Project - means the “commencement of construction activities” occurred before the effective date of this permit (modified EPA CGP)

Operator - means any party associated with a construction project that meets either of the following two criteria: 1. The party has operational control over either the construction plans and specifications, including the ability to make modifications to those plans and specifications; or 2. The party has day-to-day operational control of those activities at a project which are necessary to ensure compliance with a storm water pollution prevention plan (SWPPP) for the site or other permit conditions (e.g., they are authorized to direct workers at the site to carry out activities required by the SWPPP or comply with other permit conditions). (modified EPA CGP)

Outfall - The terminus of a stormwater system where the contents are released into a larger public or private stormwater management system, or into a stream or other water body.

Outstanding National Resource Waters or ONRW - means those “waters of the Commonwealth” that have been listed in Table 1 of 401 KAR 10:030, Section 1(1).

Outstanding State Resource Waters or OSRW - means those “waters of the Commonwealth” that meet the criterion of 401 KAR 10:031, Section 8.

Owner or operator - means the owner or operator of any “facility or activity” subject to regulation under the KPDES program. (modified EPA CGP)

Peak Discharge - The maximum instantaneous rate of flow of water at a particular point resulting from a storm event. Also, the maximum discharge computed for a given design flood event.

Permittee - for the purpose of this permit means the operator who obtains authorization under this permit.

Person - means an individual, trust, firm, joint stock company, corporation (including a government corporation), partnership, association, federal agency, state agency, city, commission, political subdivision of the Commonwealth, or any interstate body. (KRS 244.01-010(17))

Point Source - means any discernible, confined, and discrete conveyance, including but not limited to, any pipe, ditch channel, tunnel, conduit, well, discrete fissure, container, rolling stock, concentrated animal feeding operation, landfill leachate collection system, vessel or other floating craft from which pollutants are or may be discharged. This term does not include return flows from irrigated agriculture or a agricultural stormwater runoff. (401 KAR 5:002 (222) & EPA CGP)

Pollutant - means and includes dredged spoil, solid waste, incinerator residue, sewage, sewage sludge, garbage, chemical, biological or radioactive materials, heat, wrecked or discarded equipment, rock, sand, soil, industrial, municipal or agricultural waste, and any substance resulting from the development, processing, or recovery of any natural resource which may be discharged into water. (KRS 244.01-010(35))

Pond - An inland body of standing water that is usually smaller than a lake.

Public Water - Stormwater runoff that originates in whole or part from or is conveyed by publicly owned facilities such as roads.

Rainfall Erosivity Factor or R Factor - means a measure of the erosive force and intensity of rain in a normal year. Two components of the factor are total energy and the maximum 30-min intensity of storms. The R-Factor is the sum of the product of these two components for all major storms in the area during an average year. (USDA Handbook 703)

Rainfall Erosivity Waiver - means a waiver, available only to “small construction activities”, that is based on the “rainfall erosivity” factor for the project.

Receiving Water - means the “water of the Commonwealth” as defined in KRS 224.01-010 (33) into which the regulated stormwater discharges. (modified EPA CGP)

Redevelopment - The improvement of a lot or lots that have been previously developed.

Revised Universal Soil Loss Equation or RUSLE - means an equation used to predict soil loss in an area. (USDA Handbook 703)

Riprap - A combination of large stone, cobbles and boulders used to line channels, stabilize stream banks, and reduce runoff velocities

Runoff - The water resulting from precipitation that is not absorbed by the soil. Also can be referred to as stormwater runoff.

Runoff Coefficient - means the fraction of total rainfall that will appear at the conveyance as runoff. (EPA CGP)

Sanitary Sewer - A system of underground conduits that collects and delivers wastewater from toilets, sinks and other plumbing fixtures to a wastewater treatment plant.

Sediment - Solid material, either mineral or organic, that is in suspension, is being transported, or has been moved from its site of origin by erosion.

Sewage - Human wastes carried by water from residences, buildings, industrial establishments or other places, together with such industrial wastes, stormwater or other water as may be present; or any substance discharged from a sanitary sewer collection system.

Sinkhole - A depression in karst areas, often but not always characterized by closed contours on a topographic map. A sinkhole throat, or opening to the subsurface, may or may not be visible. Field verification may be required in areas where the depth of the depression is below the tolerance of currently available topographic mapping. The extent of the area considered to be a sinkhole includes an appropriate vegetated or other buffer zone to ensure filtration and protection from contamination by surface runoff.

Site - means the land or water area where any “facility or activity” is physically located or conducted, including adjacent land use in connection with the facility or activity. (EPA CGP)

Small Construction Activity - is defined at 401 KAR 5:002, Section 1(293). A small construction activity includes clearing, grading, and excavating resulting in a land disturbance that will disturb equal to or greater than one acre and less than five acres of land or will disturb less than one acre of total land area but is part of a larger common plan of development or sale that will ultimately disturb equal to or greater than one acre and less five acres. Small construction activity does not include routine maintenance that is performed to maintain the original line and grade, hydraulic capacity or original purpose of the site. (modified EPA CGP)

Stormwater - means storm water run-off, snow melt run-off, and surface run-off and drainage. (EPA CGP)

Stormwater Discharge Related Activities - as used in this permit include: activities that cause, contribute to, or result in stormwater point source pollutant discharges, including but not limited to: excavation, site development, grading and other surface disturbance activities; and measures to control stormwater including the siting, construction and operation of BMPs to control, reduce or prevent stormwater pollution. (EPA CGP)

Stormwater System - The system of roadside drainage, roadside curbs and gutters, curb inlets, swales, catch basins, manholes, gutters, ditches, pipes, lakes, ponds, sinkholes, channels, creeks, streams, storm drains, water quality best management practices, and similar conveyances and facilities, both natural and manmade, which are designated or used for collecting, storing, or conveying stormwater, or through which stormwater is collected, treated, stored or conveyed.

Stormwater Management Facilities - Structures and constructed features designed for the collection, conveyance, storage, treatment and disposal of stormwater runoff into and through the stormwater system. Stormwater management facilities include vegetative or structural measures, or both, to control the increased volume, rate, and quality of stormwater runoff caused by manmade changes to the land.

Stormwater Pollutant Prevention Plan (SWPPP) - means a site-specific, written document that: (1) identifies potential sources of stormwater pollution at the construction site; (2) describes practices to reduce pollutants in stormwater discharges from the construction site; and identifies procedures the operator will implement to comply with the terms and conditions of a construction general permit. (modified EPA Developing Your Stormwater Pollution Prevention Plan Guide For Construction Sites [Interim] January 2007).

Stream - A linear surface water conveyance that can be characterized with either perennial or ephemeral base flow. Characterized as a blue line on a 7.5-minute USGS quadrangle, or as any natural surface water conveyance that has a defined bed and banks, which carries runoff water or base flow.

Structure - Anything constructed or erected such that the use of it requires a more or less permanent location on or in the ground. Such construction includes, but is not limited to, objects such as buildings, towers, smokestacks, overhead transmission lines, carports and walls.

TMDL Waiver - means a waiver, available only to “small construction activities”, based on an EPA established or approved TMDL.

Top of Bank - The uppermost limit of the active channel of a stream containing normal flows, usually marked by a break in slope. Often referred as the elevation of flowing water during bankfull flows, which occur every 2-3 years.

Total Maximum Daily Load or TMDL - means the sum of the individual wasteload allocations (WLAs) for point sources and load allocations (LAs) for nonpoint sources and natural background. If a receiving water has only one point source discharger, the TMDL is the sum of that point source WLA plus the LAs for any nonpoint source pollution and natural background sources, tributaries, or adjacent segments. TMDLs can be expressed in terms of mass per time, toxicity, or other appropriate measure. (EPA CGP)

Transporting - Any moving of earth materials from one place to another, other than such movement incidental to grading, as authorized on an approved plan.

USACE - United States Army Corps of Engineers.

Utility, public or private - Any agency which under public franchise or ownership, or under certification of convenience and necessity provides the public with electricity, natural gas, steam, communication, rail transportation, water, sewage collection, or other similar service.

Vegetation - Collection of plant life, including trees, shrubs, bushes, and grass.

Wastes, industrial/commercial - Liquid or other wastes resulting from any process of industry, manufacture, trade or business, or from the development of any natural resources.

Wastes, other - Decayed wood; sawdust; shavings; fallen bark; fallen leaves; lawn clippings; animal wastes; used or previously applied lime; garbage; trash; refuse, loose used paper, paper products, plastic containers, or metal containers; ashes, offal, discarded tar; discarded paint; discarded or uncontained solvents; used, discarded, or spilled petroleum products, anti-freeze, motor vehicle fluids; used or discarded tires, gas tanks, or chemicals; or any other used, uncontained, or unpackaged, or disposed of materials which may discharge to or otherwise enter the stormwater system.

Water or Waters of the Commonwealth - as defined in KRS 224.01-010(33) means and includes any and all rivers, streams, creeks, lakes, ponds, impounding reservoirs, springs, wells, marshes, and all other bodies of surface or underground water, natural or artificial, situated wholly or partly within or bordering upon the Commonwealth or within its jurisdiction. (KRS 244.01-010(33))

Waters or Waters of the State - Any and all water, public or private, on or beneath the surface of the ground, which are contained within, flow through or border upon Kentucky or any portion thereof except those bodies of water confined to and retained within the limits of private property in single ownership which do not combine or effect a junction with natural surface or underground waters.

Water Pollution - means the alteration of the physical, thermal, chemical, biological, or radioactive properties of the waters of the Commonwealth in such a manner, condition, or quantity that will be detrimental to the public health or welfare, to animal or aquatic life or marine life, to the use of such waters as present or future sources of public water supply or to the use of such waters for recreational, commercial, industrial, agricultural, or other legitimate purposes. (KRS 244.01-010(34))

Water Quality Buffer - A use-restricted, vegetated area that is located along the perimeter of local waters, containing natural vegetation and grasses, enhanced or restored vegetation.

Watercourse - A channel, natural depression, gully, stream, creek, pond, reservoir or lake in which stormwater runoff and floodwater flows either regularly or infrequently. This includes major drainageways for carrying urban stormwater runoff.

Watershed - A region or area bounded peripherally by a divide and draining ultimately to a particular watercourse or body of water.

Wetlands - An area that is inundated or saturated by surface water or groundwater at a frequency and duration sufficient to support, and that under normal circumstances does support, a prevalence of vegetation

Notes

Best Management Practices (BMPs) for Controlling Erosion, Sediment, and Pollutant Runoff from Construction Sites

This document was originally produced by Tetra Tech, Inc., with funding provided in part by a grant from the U.S. Environmental Protection Agency (EPA) through the Kentucky Division of Water (KDOW), Nonpoint Source Section and the Kentucky Division of Conservation (KDOC), as authorized by the Clean Water Act Amendments of 1987, Section 319(h) Nonpoint Source Implementation Grant #C9994861-01. This document was revised in 2009 by the Kentucky Transportation Center at the University of Kentucky to reflect new KPDES General Permit provisions. Mention of trade names or commercial products, if any, does not constitute endorsement. This document is printed on recycled paper.

2004 Technical Review Committee

Kentucky Division of Water: Jory Becker, Tom Gabbard, John Eisiminger
Kentucky Transportation Cabinet: Danny Jasper, Shelby Jett
Kentucky Division of Conservation: Jennifer Thompson, Carolyn Hestand
USDA NRCS: Kurt Mason, Charles Farmer
UK Cooperative Extension Service: Richard Warner
Kentucky Water Resources Research Institute: James Kipp
Center for the Environment: Lindell Ormsbee, Tracy Farmer
Kentucky Transportation Center: Ray Werkmeister
Louisville-Jefferson Co. Metropolitan Sewer District: Randy Stambaugh, Larry Pardue
Lexington-Fayette Urban County Government: Darryl Bennett, David Carroll, Tim Koch, Greg Lubeck, David Gabbard
City of Bowling Green: Jeff Lashlee
Sanitation District #1: Sean Blake
Boone, Kenton, Campbell Conservation District: Mary Kathryn Dickerson
Hardin County Government: Vicki Brackett
City of Winchester: John Haddix
City of Henderson: John Baker
Kentucky Institute for Sustainable Development: Russ Barnett
Kentucky Waterways Alliance: Judy Petersen
Burgess & Niple: Scott Wolf, Jody Barker
Tetra Tech: John Kosco, Richard Walker, William Marshall, Barry Tinning

This manual was originally produced by Richard Walker and Barry Tinning of Tetra Tech, Inc., with support from the Kentucky Environmental and Public Protection Cabinet. Emily Faalasli of Tetra Tech created the illustrations and layout. Photographs were provided by the Kentucky Transportation Cabinet, the Upper Chattahoochee Riverkeeper, Tetra Tech, product vendors, and other sources. Primary technical support was provided by John Kosco and William Marshall of Tetra Tech. The Environmental and Public Protection Cabinet (EPPC) and Tetra Tech do not discriminate on the basis of race, color, national origin, sex, age, religion, or disability. The EPPC and Tetra Tech will provide, on request, reasonable accommodations including auxiliary aids and services necessary to afford an individual with a disability an equal opportunity to participate in all services, programs and activities. To request materials in an alternative format, contact the Kentucky Division of Water, 14 Reilly Road, Frankfort, KY, 40601 or call (502) 564-3410 or contact Tetra Tech, 10306 Eaton Place, Suite 340, Fairfax VA 22030, (703) 385-6000.

Revised October 2009.

In partnership with:



Kentucky Transportation Center
Technology Transfer Program
University of Kentucky
176 Raymond Building
Lexington, Kentucky 40506-0281
800-432-0719
www.kyt2.com



Kentucky Department for Environmental Protection
Division of Compliance Assistance
300 Fair Oaks Lane
Frankfort, KY 40601
800-926-8111
www.dep.ky.gov



Kentucky Department for Environmental Protection
Division of Water
200 Fair Oaks Lane, Fourth Floor
Frankfort, KY 40601
502-564-3410
www.water.ky.gov